



Business Machines

**2022 Machine
Catalog**



PREMIUM

REPLACEMENT CARTRIDGE



The Next Generation Premium Replacement Cartridge Has Arrived.

When you purchase your next
new or refurbished copier,
printer, fax, or multifunction,
remember the next toner for
that machine should be NXT.

NXT Premium Replacement Cartridges are inspected and adhere to a quality control process that virtually eliminates DOA problems that haunt many of today's compatible supplies.

Environmentally focused packaging and recycling program create an eco-friendly substitute to OEM supplies.

NXT Premium Replacement Cartridges provide users with quality and reliability at a price that makes print affordable.



The NeXT Best Thing in Toner!



The Fastest imagePROGRAF. Ever.

Up to 4 D Prints/Minute*
Up to 244 D Prints/Hour**

Integrated 100-Print
Capacity Top Stacker

Dual-Roll Intelligent Media-Handling System
that Detects Media Type, Width, and Length

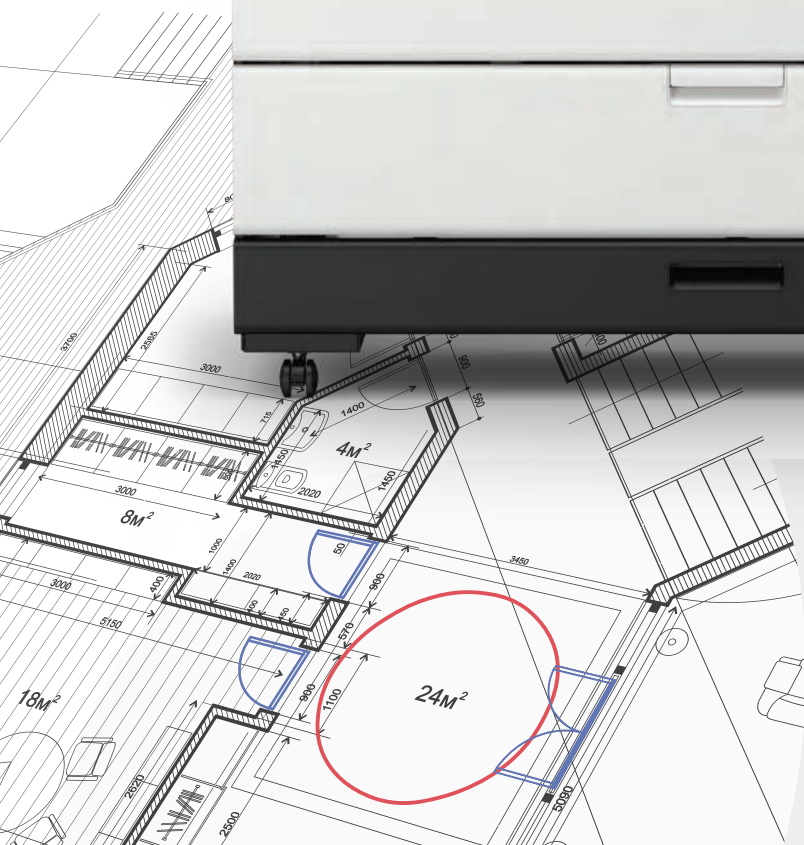

imagePROGRAF

TZ Series

Fellowes
AIR PURIFIERS



The Safest Workplaces Have Fellowes

Only Fellowes AeraMax[®] Pro air purifiers sense and react to occupancy and air quality changes, capture 99.99% of airborne coronavirus*, and show that the air is clean.

*Fellowes AeraMax Pro air purifiers were demonstrated through independent laboratory testing to be effective in reducing aerosolized airborne concentration of Human Coronavirus 229E in a test chamber, reaching 99.99% airborne reduction within 1 hour of operation.

PRODUCT					PAGES
MULTIFUNCTION - Facsimiles, Copiers, Printers, Scanners & Cabinets					1-47
Mfg	Pages	Mfg	Pages	Mfg	Pages
Brother.....	1-5	Epson.....	24-25	Lexmark.....	31-39
Canon.....	6-15	Fujitsu.....	26	Quick Quality Cabinets.....	40
Copystar/Kyocera.....	16-23	Hewlett Packard.....	27-30	Troy.....	42-45
				Xerox.....	46-47
LARGE FORMAT Canon - 48-49, Epson - 50, Laminators - 51-52					48-52
CALCULATORS					54-79
TYPEWRITERS & PRINTWHEELS					80-85
CASH MANAGEMENT					86-99
Product	Pages	Product	Pages	Product	Pages
Cash Registers & Receipt Printers.....	88-92	Check Writers.....	99		
Counterfeit Detectors & Money Counters.....	92-98				
PHONE ACCESSORIES					100-101
TIME RECORDERS					102-113
SHREDDERS					114-131
PAPER HANDLING					133-165
Product	Pages	Product	Pages	Product	Pages
Joggers & Padding Presses.....	133	Paper Folders.....	146-148	Bursters, Slitters & Trimmers.....	152-159
Binders.....	134-137	Letter Openers.....	148-149	Staplers.....	160-163
Laminators.....	138-145	Hole Punches.....	149-151		
PROJECTION PRODUCTS					165-167
LABEL MAKERS					168-172
SURGE PROTECTORS					173-177
ELECTRONICS Office Accessories - 178, Memory Cards - 179					178-179
BRIEFCASES/PORTFOLIOS					181-183
RIBBONS					184-194

















Manufacturer Customer Service















Dear Customer, We have endeavored to provide you with the most current phone numbers available; however, There may be some incorrect phone numbers and we apologize for the inconvenience.

TIME ZONE*	COMPANY	NUMBER	TIME ZONE*	COMPANY	NUMBER	TIME ZONE*	COMPANY	NUMBER
C	ACCO.....	800-477-9900	C	GBC.....	See ACCO		Quartet.....	See ACCO
	AccuBanker.....	305-594-0950	C	GRC.....	888-666-0959		Quick Quality Cabinets.....	888-831-3030
	Acroprint.....	800-334-7190		Hewlett-Packard.....	800-474-6836		Rapid.....	800-627-9140
	Adler Royal.....	800-272-6229		IBM/Lexmark			RCA.....	877-722-4908
	Amano.....	800-367-6649		Inkjet Printers.....	800-332-4120		Rabio.....	773-253-5086
	APC.....	800-555-2725		Laser Printers.....	800-539-6275		Ricoh.....	800-327-8349
	Apollo.....	See ACCO		Intimus.....	800-775-2122		Royal.....	800-524-0799
P	AT&T.....	800-222-3111		Kantek.....	800-536-3212		ECR.....	800-272-6229
	Attalus.....	770-616-9116		Kensington.....	See ACCO		Royal Sovereign.....	800-397-1025
	Brother.....	800-284-4329		Konica Minolta.....	800-456-6422	C	Sam4s (CRS) Dealers Only.....	800-333-4949
	Calculated Industries.....	800-854-8075		Kyocera.....	Call Arli for Details		Samsung.....	800726-7864
	Canon.....	800-652-2666	C	LandAirSea.....	847-462-8100		Sharp.....	800-237-4277
	Casio			Lathem.....	404-691-1064		Accessories.....	800-642-2122
	Tech Support.....	800-435-7732	C	Martin Yale.....	800-225-5644	P	Smith Corona.....	800-875-7000
	ERC Prog.....	800-633-5586		Max USA.....	800-223-4293		Solo.....	800-333-6292
	CI Inks.....	800-868-6780		MBM.....	800-223-2508		Swingline.....	See ACCO
	Copi-Mate (CMR).....	800-645-5612		Monroe.....	888-666-7631	C	Texas Instruments.....	800-842-2737
	Copystar.....	Call Arli for Details		Nakajima.....	800-809-7138	C	Tripp-Lite.....	773-869-1234
	Count Machinery.....	760-489-1400		Fax.....	800-809-7153		Victor.....	800-628-2420
	Dahle.....	800-995-1379		Okidata.....	800-654-3282		Widmer.....	800-424-4459
	Dell.....	800-456-3355	P	Panamax.....	800-472-5555		Workwell Tech.....	919-872-5800
	Drylam.....	See Martin Yale		Panasonic.....	800-211-7262		Xerox.....	800-821-2797
	Duplo.....	949-752-8222		Paymaster.....	888-717-5577			
	Dust Off (Falcon).....	800-332-5266		Plantronics.....	888-752-6876		Special Order Parts.....	800-521-4600 ext:2012/2018
	Dymo.....	877-289-3966	C	Porelon.....	800-451-8075			
	Epson.....	800-463-7766		PostMark.....	805-888-0015			
	Fellowes.....	800-955-0959	C	Pyramid.....	888-479-7264			











*All time zones EST except where noted

TABLE OF CONTENTS

	COUNTERFEIT DETECTORS..... 92 MONEY COUNTERS 93
	TIME RECORDERS..... 102-103
	PRINTWHEELS..... 84
	TIME RECORDERS..... 104-105
	SURGE, UPS 173
	LAMINATING SUPPLIES 138
	LABELERS & TAPES..... 168-172 MULTIFUNCTION 1-5
	SPECIALITY CALCS..... 56-57
	CALCULATORS..... 58-61 LARGE FORMAT PRINTERS..... 48-49 MULTIFUNCTION 6-15
	CALCULATORS..... 62-64
	RIBBONS 184
	TIME RECORDER 111
	TIME CLOCK RIBBONS 113, 184
	MULTIFUNCTION 16-17
	SCISSORS, TRIMMERS..... 152-153 SHREDDERS..... 114-115 STAPLERS..... 160
	LAMINATORS 52, 139
	BURSTERS & CUTTERS..... 155 FOLDERS..... 148

	MEMORY CARDS..... 179
	LARGE FORMAT PRINTERS..... 50 MULTIFUNCTION 24-25 PROJECTORS..... 165
	BINDERS..... 134-135 LAMINATORS 140-141 SHREDDERS 116-119 TRIMMERS 155
	MULTIFUNCTION 26
	BINDERS..... 136-137 LAMINATORS 52, 142-143 SHREDDERS 120-124
	RIBBONS 185
	MULTIFUNCTION 27-30
	SHREDDERS 126-127
	TYPEWRITERS..... 82-83
	LASER POINTERS 166 SURGE PROTECTOR..... 173
	MULTIFUNCTION 18-23
	TIME RECORDERS..... 106-107
	MULTIFUNCTION 31-39
	FOLDERS..... 146-147 HOLE PUNCHES 149 LETTER OPENERS 148 PADDING PRESSES 133 SLITTERS & TRIMMERS..... 156-157
	CHECK WRITERS 99 STAPLERS..... 161

	FOLDERS..... 146
	SHREDDERS 128-129
	TRIMMERS 158
	CALCULATORS 65-67
	PRINTWHEELS..... 84
	TYPEWRITERS..... 80-81
	SURGE PROTECTORS..... 174
	CALCULATORS/ECR 55, 87
	CHECK WRITERS 99
	PHONES/ACCESSORIES 100-101
	RIBBONS 184
POSTMARK	LETTER OPENERS 149
	TIME RECORDERS 108-110
	MACHINE STANDS 40
	FOLDING CART 181
	PROJECTOR ACCESSORIES 166-167
rarotype	PRINTWHEELS..... 84
	MONEY COUNTERS 98
	CASH REGISTERS..... 88
	PENCIL SHARPENERS..... 178
	SHREDDERS..... 130-131
	TIME RECORDERS..... 111
	TYPEWRITERS..... 81
	CASH DRAWERS 94
	COIN SORTERS 95
	COUNTERFEIT DETECTORS..... 96
	LAMINATORS 51,144-145
	MONEY COUNTERS 97
	PAPER TRIMMERS 51, 155

	CASH DRAWERS 91
	CASH REGISTERS..... 89
	RECEIPT PRINTERS..... 90
	CALCULATORS..... 68-71
	CASH REGISTERS..... 92
	BRIEFCASES..... 181-183
	HOLE PUNCHES 150-151
	STAPLERS..... 162-163
	TRIMMERS 159
	CALCULATORS..... 72-74
	SURGE, UPS, CHARGERS..... 175-177
	MULTIFUNCTION 42-45
	CALCULATORS..... 75-79
	DESK CONVERTORS 178
	CHECK SIGNER 99
	TIME RECORDERS 112
	MULTIFUNCTION 46-47

We have placed icons on most items in the catalog to help enhance your shopping experience.



- New for the 2022 catalog.



- Item cannot be returned.



- Must be shipped truck.



- Item is refurbished.



- Does not come with supplies.



- Environmentally friendly.



M406 MICR Printer



Fast printing and features like duplexing **make check printing easy and efficient** for small to medium-sized businesses. HP printers have the industry's strongest security because they're always on guard, continually stopping threats while adapting to new ones. And only HP printers can automatically self-heal from attacks. Get HP's award-winning security combined with optimized functionality from TROY.

The World's Most Secure Check Printing

The operating code (BIOS) is automatically checked during startup and repairs itself if compromised.

Common Criteria certified to continually monitor memory activity to detect and stop attacks in real time.

Firmware is automatically checked during startup to determine if it's authentic code—digitally signed by HP.

The printer's outgoing network connections are inspected to stop suspicious requests and thwart malware.



Standard HP LaserJet Printer

Enhanced TROY Printer



Print Secure Checks In-House

Eliminate security risks of preprinted check stock. Add your logo, payee, signature, and MICR line. Also works with preprinted check stock to protect the payee and amount from alteration.



Efficiency & Security

Reduce manual logging and chain of custody protocols. Plus **use one stock across multiple accounts by adding the MICR line at the point of issue.** Built-in tray locks and steel shielding protect check stock.



Quality & Reliability

MICR fonts created specifically for secure check printing. Patented MICR toner features **high adhesion and rigorous quality testing** to ensure a strong MICR signal. The only HP approved OEM MICR Toner on the market.



MICR Fonts

Security fonts designed for optimal reading and minimal errors.



MICR Toner Secure™

The World's Most **Fraud Resistant** MICR Toner™; full standard yield cartridge included.



Paper Tray Locks

Printer specific, built-in locks prevent paper theft by refusing unauthorized access. (optional)



intelliFAX2840 *High-Speed Laser Fax, Copier*

ITEM NO.
BRTFAX2840

\$329⁹⁹



- 33.6 Kbps / 2.5 spp
- 16 MB @ 400 pages
- 22 touch / 200 speed dials
- Up to 21 cpm
- 250 sheet input tray
- 20 sheet ADF
- 8.5" x 14" max paper size

- 10,000 page duty cycle
- Answer machine interface
- USB port for future printing
- 1 year limited warranty
- 15" x 15" x 12" / 20 lbs
- TN450 toner, DR420 drum

intelliFAX2940 *High-Speed Laser Fax, Copier*

ITEM NO.
BRTFAX2940

\$459⁹⁹



- 33.6 Kbps / 2.5 spp
- 16 MB @ 500 pages
- 272 broadcast locations
- Up to 24 cpm
- 250 sheet input tray
- 30 sheet ADF
- 8.5" x 14" max paper size

- Handset / Caller ID ready
- USB port for future printing
- 1 year limited warranty
- 14.7" x 14.6" x 12" / 19.8 lbs
- TN450 toner, DR420 drum

MFC7240 *Laser Fax, Copier, Printer, Scanner*

ITEM NO.
BRTMFC7240

\$359⁹⁹



- 14.4 Kbps / 200 speed dials
- Up to 21 cpm / ppm
- Up to 2400 x 600 dpi
- 250 sheet input tray
- 20 sheet ADF
- 8.5" x 14" max paper size
- 10,000 page duty cycle

- 16 MB, USB (Windows / Mac)
- 1 year limited warranty
- 14.7" x 14.6" x 12" / 20 lbs
- TN450 toner, DR420 drum

MFC8220 *Laser Fax, Copier, Printer, Scanner*

ITEM NO.
BRTMFC8220

\$499⁹⁹



- 33.6 Kbps / 300 speed dials
- Up to 21 cpm / ppm
- Up to 2400 x 600 dpi
- 250 sheet input tray
- 30 sheet ADF
- 8.5" x 14" max paper size
- 20,000 page duty cycle

- Email, Image, OCR, File
- USB, Parallel
- 32 MB (Windows / Mac)
- 1 year limited warranty
- 17" x 17.8" x 18" / 26 lbs
- TN570 toner, DR510 drum

DCPL2550DW *Laser Copier, Printer, Scanner w/Wireless Network and Duplex*

ITEM NO.
BRTDCPL2550DW

\$399⁹⁹



- Up to 36 cpm / ppm
- Up to 2400 x 600 dpi
- 250 sheet tray, 50 page ADF
- 8.5" x 11" platen; 14" paper
- 15,000 page duty cycle
- Automatic duplex printing

- Mobile device enabled
- USB, Ethernet, WiFi
- 128 MB (Windows / Mac)
- 1 yr warranty, 30 days return
- 16.1" x 15.7" x 12.5" / 25.6 lbs
- TN730 toner, DR730 drum

intelliFAX4100e *Business-Class Laser Fax, Copier*

ITEM NO.
BRTFAX4100E

\$449⁹⁹



- 33.6 Kbps / 3 spp
- 8 MB @ 500 pages
- 32 touch / 100 speed dials
- Up to 15 cpm
- 250 sheet input tray
- 30 sheet ADF
- 8.5" x 14" max paper size

- 15,000 page duty cycle
- Answer machine interface
- 1 year limited warranty
- 17" x 17" x 13" / 23 lbs
- TN460 toner, DR400 drum

BRTPPF5750E.....\$1,299.99

DCPL5500DN *Laser Copier, Printer, Color Scanner w/Network and Duplex*

ITEM NO.
BRTDCPL5500DN

\$849⁹⁹



- Up to 42 cpm / ppm
- Up to 1200 x 1200 dpi
- 50 and 250 sheet trays
- 40 sheet ADF
- 8.5" x 11" platen; 14" paper
- 50,000 page duty cycle
- Automatic duplex printing
- 3.7" color Touchscreen

- AirPrint, Mopria, Cloud apps
- USB, Ethernet, Web connect
- 256 MB (Windows / Mac)
- 1 year limited warranty
- 19" x 17" x 17" / 36 lbs
- TN850 toner, DR820 drum

DCPL5600DN *Laser Copier, Printer, Color Scanner w/Network and Duplex*

ITEM NO.
BRTDCPL5600DN

\$809⁹⁹



- Up to 42 cpm / ppm
- Up to 1200 x 1200 dpi
- 50 and 250 sheet trays
- 70 sheet ADF
- 8.5" x 14" platen/paper size
- 50,000 page duty cycle
- Automatic duplex printing
- 3.7" color Touchscreen

- AirPrint, Mopria, Cloud apps
- USB, Ethernet, Web connect
- 256 MB (Windows / Mac)
- 1 year limited warranty
- 19.5" x 17" x 19" / 38 lbs
- TN850 toner, DR820 drum

BRTDCPL5650DN.....\$839.99

MFCJ491DW *Color Inkjet Fax, Copier, Printer, Scanner w/Wireless Network and Duplex*

ITEM NO.
BRTMFCJ491DW

\$246⁹⁹



- 14.4 Kbps / 40 speed dials
- Up to 12 ppm black, 6 color
- Up to 6000 x 1200 dpi
- 100 sheet tray, 20 page ADF
- 8.5" x 11" platen; 14" paper
- Automatic duplex printing
- 1.8" Color display

- Web connect, Cloud apps
- Mobile device enabled
- USB, WiFi (Windows / Mac)
- 1 yr warranty, 30 days return
- 15.7" x 13.4" x 6.8" / 18 lbs
- LC3011 or 3013 series inks

MFCJ680DW *Color Inkjet Fax, Copier, Printer, Scanner w/Wireless Network and Duplex*

ITEM NO.
BRTMFCJ680DW

\$329⁹⁹



- 14.4 Kbps / 200 speed dials
- Up to 12 ppm black, 10 color
- Up to 6000 x 1200 dpi
- 100 sheet tray, 20 page ADF
- 8.5" x 11" platen; 14" paper
- Automatic duplex printing
- 2.7" Color TouchScreen display

- Web connect, Cloud apps
- Mobile device enabled
- USB, WiFi (Windows / Mac)
- 1 yr warranty, 30 days return
- 15.7" x 13.4" x 6.8" / 18 lbs
- LC201 / LC203 series inks

MFCJ895DW *Color Inkjet Fax, Copier, Printer, Scanner w/Wireless Network and Duplex*

ITEM NO.
BRTMFCJ895DW

\$395⁹⁹



- 14.4 Kbps / 200 speed dials
- Up to 12 ppm black, 10 color
- Up to 6000 x 1200 dpi
- 100 sheet tray, 20 page ADF
- 8.5" x 11.7" platen; 14" paper
- Automatic duplex printing
- 2.7" Color TouchScreen display

- AirPrint, Mopria, Cloud apps
- USB, Ethernet, WiFi, NFC
- 2 yr warranty, 30 days return
- 18.7" x 17.7" x 9.9" / 16.8 lbs
- LC201 / LC203 series inks

MFCJ995DW *Color Inkjet Fax, Copier, Printer, Scanner w/Wireless Network and Duplex*

ITEM NO.
BRTMFCJ995DW

\$699⁹⁹



- 14.4 Kbps / 200 speed dials
- Up to 12 ppm black, 10 color
- Up to 6000 x 1200 dpi
- 150 sheet tray, 20 page ADF
- 8.5" x 11" platen; 14" paper
- Automatic duplex printing
- 2.7" Color TouchScreen display

- Web connect, Cloud apps
- NFC & Mobile device enabled
- USB, Ethernet, WiFi (Win/Mac)
- 2 yr warranty, 30 days return
- 17.1" x 13.4" x 7.7" / 19.2 lbs
- LC3033 or 3035 series inks

MFCJ5830DW *Color Inkjet Fax, Copier, Printer, Scanner w/Wireless Network and Duplex*

ITEM NO.
BRTMFCJ5830DW

\$1,069⁹⁹



- 33.6 Kbps / 250 broadcast
- Up to 35 ppm black, 27 color
- Up to 4800 x 1200 dpi
- 100 and 250 sheet trays
- 50 sheet ADF
- 8.5" x 11" platen; 14" ADF
- Automatic duplex printing

- 3.7" swipe TouchScreen
- Web connect, Cloud apps
- 128MB, Mobile enabled
- USB, Ethernet, WiFi, PictB
- 2 yr warranty, 30 days return
- 21" x 15.7" x 12" / 38 lbs
- LC3029 series inks

MFCJ6530DW *Color Inkjet Fax, Copier, Printer, Scanner w/Wireless Network and Duplex*

ITEM NO.
BRTMFCJ6530DW

\$999⁹⁹



- 33.6 Kbps / 250 broadcast
- Up to 35 ppm black, 27 color
- Up to 4800 x 1200 dpi
- 250 sheet tray, 50 page ADF
- 11" x 17" platen/paper size
- 30,000 page duty cycle
- Automatic duplex printing
- 2.7" TouchScreen display

- Web connect, Cloud apps
- 128 MB, Mobile enabled
- USB, Ethernet, WiFi
- 2 yr warranty, 30 days return
- 22.6" x 18.8" x 12" / 43 lbs
- LC3017 series inks

BRTMFCJ5830DWXL (w/ INKvestment Cartridges) **\$1,199.99**

BRTMFCJ6535DW **\$1,499.99**

MFCJ6545DW *Color Inkjet Fax, Copier, Printer, Scanner w/Wireless Network and Duplex*

ITEM NO.
BRTMFCJ6545DW

\$1,045⁹⁹



- 33.6 Kbps / 200 speed dials
- Up to 22 ppm black, 20 color
- Up to 4800 x 1200 dpi
- 100 and 250 sheet trays
- 50 sheet ADF
- 11" x 17" platen/paper size
- 30,000 page duty cycle

- Automatic duplex printing
- 3.7" swipe TouchScreen
- Web connect, Cloud apps
- 2 yr warranty, 30 days return
- 22.5" x 18.8" x 12.2" / 44.3 lbs
- LC3037 or 3039 series inks

BRTMFCJ6545DWXL (w/ INKvestment Cartridges) **\$1,272.99**

MFCJ6930DW *Color Inkjet Fax, Copier, Printer, Scanner w/Wireless Network and Duplex*

ITEM NO.
BRTMFCJ6930DW

\$2,622⁹⁹



- 33.6 Kbps / 100 speed dials
- Up to 22 ppm black, 20 color
- Up to 4800 x 1200 dpi
- (2) 250 and 100 sheet trays
- 50 sheet ADF
- 8.5" x 11.7" platen/paper size
- Automatic duplex pt/co/sc

- 3.7" color touchscreen
- NFC & Mobile device enabled
- USB, Ethernet, WiFi
- 2 yr warranty, 30 days return
- 22.6" x 18.8" x 14.7" / 51 lbs
- LC3017 series inks

MFCL2710DW Laser Fax, Copier, Printer, Scanner w/Network and Duplex

ITEM NO.
BRTMFCL2710DW

\$399⁹⁹

- 33.6 Kbps / 200 speed dials
- Up to 32 cpm / ppm
- 250 sheet tray, 50 page ADF
- 8.5" x 11.7" platen, 14" paper
- 15,000 page duty cycle
- Automatic duplex printing
- Mobile device enabled



- USB, Ethernet, WiFi
- 64 MB (Windows / Mac)
- 1 year limited warranty
- 22.5" x 20" x 12.5" / 26 lbs
- TN760 toner, DR730 drum

MFCL2720DW Laser Fax, Copier, Printer, Color Scanner w/Wireless Network and Duplex

ITEM NO.
BRTMFCL2720DW

\$599⁹⁹

- 33.6 Kbps / 200 speed dials
- Up to 30 cpm / ppm
- 250 sheet tray, 35 page ADF
- 8.5" x 11" platen; 14" paper
- 10,000 page duty cycle
- Automatic duplex printing
- Mobile device enabled



- USB, Ethernet, WiFi
- 64 MB (Windows / Mac)
- 1 year limited warranty
- 16" x 15.7" x 12.5" / 25 lbs
- TN660 toner, DR630 drum

MFCL2750DW Laser Fax, Copier, Printer, Scanner w/Wireless Network and Duplex

ITEM NO.
BRTMFCL2750DW

\$599⁹⁹

- 33.6 Kbps / 250 broadcast
- Up to 36 cpm / ppm
- 250 sheet tray, 50 page ADF
- 8.5" x 11" platen; 14" paper
- 15,000 page duty cycle
- Full auto duplex fx/co/pt/sc
- 2.7" Color TouchScreen display



- Mobile device enabled
- USB, Ethernet, WiFi
- 256 MB (Windows / Mac)
- 1 yr warranty, 30 days return
- 16.1" x 15.7" x 12.5" / 26.5 lbs
- TN820 toner, DR820 drum

MFCL3750CDW Color Laser Fax, Copier, Printer, Scanner w/Wireless Network and Duplex

ITEM NO.
BRTMFCL3750CDW

\$999⁹⁹

- 33.6 Kbps / 250 broadcast
- Up to 25 cpm / ppm
- Up to 2400 x 600 dpi
- 250 sheet tray, 50 page ADF
- 8.5" x 11" platen; 14" paper
- 30,000 page duty cycle
- Automatic duplex printing
- 3.7" Color TouchScreen display



- Web connect, Cloud apps
- USB, Ethernet, WiFi
- 512 MB (Windows / Mac)
- 1 yr warranty, 30 days return
- 16.1" x 18.7" x 16.3" / 52 lbs
- TN223x toners, DR223CL drum

MFCL5800DW Laser Fax, Copier, Printer, Color Scanner w/Wireless Network and Duplex

ITEM NO.
BRTMFCL5800DW

\$1,019⁹⁹

- 33.6 Kbps / 300 speed dials
- Up to 42 cpm / ppm
- Up to 1200 x 1200 dpi
- 50 and 250 sheet trays
- 70 sheet ADF
- 8.5" x 14" platen/paper size
- 50,000 page duty cycle
- Automatic duplex printing



- 3.7" color Touchscreen
- Web connect, Cloud apps
- USB, Gigabit Ethernet, WiFi
- 256 MB (Windows / Mac)
- 1 yr warranty, 30 days return
- 19.5" x 16.8" x 19" / 38 lbs
- TN820 toner, DR820 drum

MFCL6700DW Laser Fax, Copier, Printer, Color Scanner w/Wireless Network and Duplex

ITEM NO.
BRTMFCL6700DW

\$1,249⁹⁹

- 33.6 Kbps / 300 speed dials
- Up to 48 cpm / ppm
- Up to 1200 x 1200 dpi
- 50 and 250 sheet trays
- 70 sheet ADF
- 8.5" x 14" platen/paper size
- 100,000 page duty cycle
- Full auto duplex fx/co/pt/sc



- 4.85" color Touchscreen
- Web connect, Cloud apps
- USB, Gigabit Ethernet, WiFi
- 512 MB (Windows / Mac)
- 1 year limited warranty
- 19.5" x 16.8" x 20.4" / 41 lbs
- TN820 toner, DR820 drum

BRTMFCL5900DW **\$1,129.99**

MFCL6800DW Laser Fax, Copier, Printer, Color Scanner w/Wireless Network and Duplex

ITEM NO.
BRTMFCL6800DW

\$1,399⁹⁹

- 33.6 Kbps / 350 broadcast
- Up to 48 cpm / ppm
- Up to 1200 x 1200 dpi
- 50 and 250 sheet trays
- 80 sheet ADF
- 8.5" x 14" platen/paper size
- 125,000 page duty cycle
- Full auto duplex fx/co/pt/sc



- 4.85" color Touchscreen display
- Web connect, Cloud apps
- USB, Gigabit Ethernet, WiFi
- 512 MB (Windows / Mac)
- 1 yr warranty, 30 days return
- 19.5" x 16.8" x 20.4" / 41.5 lbs
- TN820 toner, DR820 drum

MFCL8610CDW Color Laser Fax, Copier, Printer, Scanner w/Wireless Network and Duplex

ITEM NO.
BRTMFCL8610CDW

\$1,599⁹⁹

- 33.6 Kbps / 300 speed dials
- Up to 33 cpm / ppm
- Up to 2400 x 600 dpi
- 50 and 250 sheet trays
- 50 sheet ADF
- 8.5" x 11" platen; 14" paper
- 40,000 page duty cycle
- Automatic duplex printing



- 3.7" TouchScreen display
- Web connect, Cloud apps
- USB, Ethernet, WiFi
- 512 MB (Windows / Mac)
- 1 yr warranty, 30 days return
- 17.1" x 20.7" x 21.2" / 61 lbs
- TN431x toners, DR431CL drum

BRTMFCL8900CDW **\$1,699.99**

HLL2300D Laser Printer w/Duplex

ITEM NO.
BRTHLL2300D

\$215⁹⁹



- Up to 27 ppm
- Up to 2400 x 600 dpi
- 250 sheet input tray
- 8.5" x 14" max paper size
- 10,000 page duty cycle

- Automatic duplex printing
- 8 MB, USB (Windows / Mac)
- 1 year limited warranty
- 14" x 14" x 7" / 15 lbs
- TN630 toners, DR630 drum

HLL2350DW Laser Printer w/Wireless Network and Duplex

ITEM NO.
BRTHLL2350DW

\$299⁹⁹



- Up to 32 ppm
- Up to 2400 x 600 dpi
- 250 sheet tray
- 8.5" x 14" max paper size
- 30,000 page duty cycle
- Automatic duplex printing
- Mobile device enabled

- USB, WiFi
- 32 MB (Windows / Mac)
- 1 yr warranty, 30 days return
- 14" x 14.2" x 7.2" / 16 lbs
- TN730 toner, DR730 drum

HLL2390DW Laser Copier, Printer, Scanner w/Wireless Network and Duplex

ITEM NO.
BRTHLL2390DW

\$299⁹⁹



- Up to 32 ppm / cpm
- Up to 2400 x 600 dpi
- 250 sheet tray
- 8.5" x 14" max paper size
- 15,000 page duty cycle
- Automatic duplex printing

- Mobile device enabled
- USB, WiFi
- 64 MB (Windows / Mac)
- 1 yr warranty, 30 days return
- 16.1" x 15.7" x 10.7" / 23 lbs
- TN730 toner, DR730 drum

HLL3230CDW Color Laser Printer w/Wireless Network and Duplex

ITEM NO.
BRTHLL3230CDW

\$449⁹⁹



- Up to 25 ppm
- Up to 600 x 2400 dpi
- 250 sheet input tray
- 8.5" x 14" max paper size
- 30,000 page duty cycle
- Automatic duplex printing

- Mobile device enabled
- USB, Gigabit Ethernet, WiFi
- 256 MB (Windows / Mac)
- 1 yr warranty, 30 days return
- 16.1" x 18.1" x 9.9" / 39.7 lbs
- TN223x toner, DR223CL drum

HLL5200DW Laser Printer w/Duplex and Wireless Network

ITEM NO.
BRTHLL5200DW

\$619⁹⁹



- Up to 42 ppm
- Up to 1200 x 1200 dpi
- 50 and 250 sheet trays
- 8.5" x 14" max paper size
- 50,000 page duty cycle
- Automatic duplex printing
- Mobile device compatible

- USB, Ethernet, WiFi
- 256 MB (Windows / Mac)
- 1 year limited warranty
- 14.7" x 15" x 10" / 24 lbs
- TN820 toner, DR820 drum

BRTHLL5200DWT (Extra Tray).....**\$1,165.99**

HLL6300DW Laser Printer w/Wireless Network and Duplex

ITEM NO.
BRTHLL6300DW

\$879⁹⁹



- Up to 48 ppm
- Up to 1200 x 1200 dpi
- 50 and 520 sheet trays
- 8.5" x 14" max paper size
- 100,000 page duty cycle
- Automatic duplex printing
- 1.8" TouchScreen display

- Mobile device enabled
- USB, Gigabit Ethernet, WiFi
- 256 MB (Windows / Mac)
- 1 yr warranty, 30 days return
- 15.7" x 15.6" x 11.3" / 29 lbs
- TN820 toner, DR820 drum

BRTHLL6200DW.....**\$649.99**

HLL8260CDW Color Laser Printer w/Duplex and Wireless Network

ITEM NO.
BRTHLL8260CDW

\$715⁹⁹



- Up to 33 ppm black / color
- Up to 2400 x 600 dpi
- 50 and 250 sheet trays
- 8.5" x 14" max paper size
- 40,000 page duty cycle
- Automatic duplex printing

- Mobile device enabled
- USB, Ethernet, WiFi
- 256 MB (Windows / Mac)
- 1 yr warranty, 30 days return
- 16" x 19" x 12.3" / 48 lbs
- TN431x toners, DR431CL drum

HLL8360CDW Color Laser Printer w/Duplex and Wireless Network

ITEM NO.
BRTHLL8360CDW

\$849⁹⁹



- Up to 33 ppm black / color
- Up to 2400 x 600 dpi
- 50 and 250 sheet trays
- 8.5" x 14" max paper size
- 60,000 page duty cycle
- Automatic duplex printing
- 2.7" TouchScreen display

- Mobile device enabled
- USB, Ethernet, WiFi
- 512 MB (Windows / Mac)
- 1 yr warranty, 30 days return
- 17.4" x 19" x 12.3" / 48 lbs
- TN431x toners, DR431CL drum

BRTHLL8360CDWT (Extra Tray).....**\$1,059.99**

DS640 *Mobile Color Page Scanner*

ITEM NO.
BRTDS640

\$149⁹⁹



- Compact and lightweight
- Up to 16 ppm black or color
- Scan paper / plastic documents
- Cards, photos, receipts, invoices
- Up to 1200 x 1200 dpi
- 8.5" x 72" max scan size

- File, image, OCR, email, FTP
- Versatile software included
- Powered through USB cable
- USB (Windows / Mac)
- 1 year limited warranty
- 11.85" x 2" x 1.45" / 1 lb

DS740D *Mobile Duplex Color Page Scanner*

ITEM NO.
BRTDS740D

\$209⁹⁹



- Single-pass duplex scanning
- Up to 16 ppm black or color
- Versatile media handling
- Documents, photos, receipts
- Up to 1200 x 1200 dpi
- 8.5" x 72" max scan size

- File, image, OCR, email, FTP
- Valuable software included
- Powered through USB cable
- USB (Windows / Mac)
- 1 year limited warranty
- 11.9" x 2.5" x 1.8" / 1.4 lbs

DS820W *Wireless Mobile Color Page Scanner*

ITEM NO.
BRTDS820W

\$229⁹⁹



- WiFi transfer documents
- Scan to PC or mobile device
- Up to 8 ppm black or color
- Cards, photos, receipts, invoices
- 4GB SD Memory Card included
- 8.5" x 32" max scan size

- File, image, OCR, e-mail, FTP
- Management software suite
- USB cable or battery powered
- USB, WiFi, SD port
- Windows / Mac compatible
- 1 year limited warranty
- 12" x 2" x 1.6" / 1 lb

DS920DW *Wireless Duplex Mobile Color Page Scanner*

ITEM NO.
BRTDS920DW

\$249⁹⁹



- Single-pass duplex scanning
- WiFi transfer documents
- Up to 8 ppm black or color
- Cards, photos, receipts, invoices
- 4GB SD Memory Card included
- 8.5" x 32" max scan size
- File, image, OCR, e-mail, FTP

- Versatile software included
- USB cable or battery powered
- USB, WiFi, SD port
- Windows / Mac compatible
- 1 year limited warranty
- 12" x 2.6" x 1.6" / 1.2 lbs

ADS1250W *Color Desktop Scanner w/Duplex and WiFi*

ITEM NO.
BRTADS1250W

\$329⁹⁹



- Single-pass duplex scanning
- Up to 25 ppm black or color
- Multi-page 20 sheet ADF
- Up to 1200 x 1200 dpi
- Scan paper / plastic documents
- File, image, OCR, e-mail

- Image rotate, text enhance
- Mobile device compatible
- Versatile software included
- USB, WiFi (Windows / Mac)
- 1 yr warranty, 30 days return
- 11.8" x 4.1" x 3.3" / 3.7 lbs

ADS1700W *Color Desktop Scanner w/Duplex and WiFi*

ITEM NO.
BRTADS1700W

\$379⁹⁹



- Single-pass duplex scanning
- Up to 25 ppm black or color
- Multi-page 20 sheet ADF
- Up to 1200 x 1200 dpi
- 2.8" color Touchscreen display
- Scan paper / plastic documents
- File, image, OCR, e-mail, FTP

- Image rotate, text enhance
- Mobile device compatible
- Versatile software included
- USB, WiFi (Windows / Mac)
- 1 yr warranty, 30 days return
- 11.8" x 4.1" x 3.3" / 3.7 lbs

ADS2200 *High Speed Color Desktop Scanner w/Duplex*

ITEM NO.
BRTADS2200

\$449⁹⁹



- Single-pass duplex scanning
- Up to 35 ppm black or color
- Multi-page 50 sheet ADF
- Up to 1200 x 1200 dpi
- One-touch simple scan
- Scan paper / plastic documents

- File, image, OCR, e-mail
- Multi-feed detection, deskew
- Versatile software included
- USB, WiFi (Windows / Mac)
- 1 yr warranty, 30 days return
- 11.8" x 5.7" x 7" / 5.9 lbs

ADS2800W *Wireless Document Scanner for Mid to Large Workgroups*

ITEM NO.
BRTADS2800W

\$649⁹⁹



- Single-pass duplex scanning
- Up to 30 ppm black or color
- Multi-page 50 sheet ADF
- Up to 1200 x 1200 dpi
- 3.7" color swipe TouchScreen
- Multi-feed detection, deskew
- Background, blank removal
- File, image, OCR, e-mail, FTP

- Web connect, Cloud apps
- Kofax VRS compatible
- Valuable software included
- USB, Gigabit Ethernet, WiFi
- Windows / Mac / Linux comp
- 1 year limited warranty
- 12" x 10" x 9.8" / 10 lbs

MG2525 Pixma Color Inkjet Photo Copier, Printer, Scanner

ITEM NO.
CNM0727C002

\$89⁹⁹



- Up to 8.0 ipm black, 4.0 color
- Up to 4800 x 600 dpi
- 60 sheet input tray
- 8.5" x 11" platen; 14" paper
- Auto power, scan, quiet mode
- Photo print, Special Filters

- My Image Garden, HD movie
- Creative Park Premium
- USB, (Windows / Mac)
- 1 year limited warranty
- 16.8" x 12" x 5.8" / 8 lbs
- PG243, PG245, CL244, CL246

MG3620 Pixma Wireless Color Inkjet Photo Copier, Printer, Scanner w/Duplex

ITEM NO.
CNM0515C022

\$99⁹⁹



- Up to 9.9 ipm black, 5.7 color
- Up to 4800 x 1200 dpi
- 20 sheet 4 x 6 photo tray
- 100 sheet input tray
- 8.5" x 11" platen; 14" paper
- Auto duplex print, AirPrint
- My Image Garden, Photo print

- Mobile device,
- USB, WiFi, PictB
- 1 year limited warranty
- 17.7" x 12" x 6" / 12 lbs
- PG240, CLi241 inks

TR4520 Pixma Color Inkjet Fax, Copier, Printer, Scanner w/Wireless Network and Duplex

ITEM NO.
CNM2984C002

\$129⁹⁹



- 33.6 Kbps / 19 groups
- Up to 8.8 ipm black, 4.4 color
- Up to 4800 x 1200 dpi
- 100 sheet tray, 20 page ADF
- 8.5" x 11" platen; 14" paper
- Automatic duplex printing

- Creative Park Premium
- AirPrint, Mopria, Cloud apps
- USB, WiFi
- 1 year limited warranty
- 17" x 16" x 8" / 13 lbs
- PGi245, CLi246 series inks

TR4720 Pixma Color Inkjet Fax, Copier, Printer, Scanner w/Wireless Network and Duplex

ITEM NO.
CNM5074C002

\$139⁹⁹



- 33.6 Kbps / 20 speed dials
- Up to 8.8 ipm black, 4.4 color
- Up to 4800 x 1200 dpi
- 100 sheet tray, 20 page ADF
- 8.5" x 11" platen; 14" paper
- Automatic duplex printing
- Creative Park, Photo Editor

- Mobile device enabled
- AirPrint, Mopria, Cloud apps
- USB, WiFi, RJ11
- 1 year limited warranty
- 17.2" x 7.5" x 11.7" / 12.7 lbs
- PG275, CLi276 series inks

TS6420 Color Inkjet Photo Copier, Printer, Scanner w/Wireless Network and Duplex

ITEM NO.
CNM4462C002

\$159⁹⁹



- Up to 13 ipm black, 6.8 color
- Up to 4800 x 1200 dpi
- Two 100 sheet trays
- 8.5" x 11" platen / paper
- Automatic duplex printing
- 1.44" OLED display
- Creative Park, Photo Editor

- AirPrint, Mopria, Cloud apps
- USB, WiFi, PictB, Bluetooth
- 1 year limited warranty
- 15.9" x 12.5" x 5.9" / 13.8 lbs
- PG260, CLi261 series inks

TR7020 Color Inkjet Photo Copier, Printer, Scanner w/Wireless Network and Duplex

ITEM NO.
CNM4460C002

\$195⁹⁹



- Up to 13 ipm black, 6.8 color
- Up to 4800 x 1200 dpi
- Two 100 sheet trays
- 35 sheet ADF
- 8.5" x 11" platen / paper
- Automatic duplex print/copy
- 1.44" OLED display

- Creative Park, Photo Editor
- AirPrint, Mopria, Cloud apps
- USB, WiFi, Bluetooth
- 1 year limited warranty
- 15.9" x 14.4" x 8" / 18 lbs
- PG260, CLi261 series inks

TR7520 Color Inkjet Fax, Copier, Printer, Scanner w/Wireless Network and Duplex

ITEM NO.
CNM2232C002

\$199⁹⁹



- 33.6 Kbps / 3 spp
- Up to 15 ipm black, 10 color
- Up to 4800 x 1200 dpi
- 20 sheet 4 x 6 photo tray
- 100 sheet tray, 20 page ADF

- 8.5" x 11" platen; 14" paper
- Automatic duplex printing
- 3" color touch LCD
- My Image Garden, HD movie
- Photo Fix II, Mobile device

- Google Cloud, Bluetooth
- USB, WiFi, PictBridge
- 1 year limited warranty
- 17.3" x 14.4" x 7.5" / 17.3 lbs
- PGi280, CLi281 series inks

Call Your Sales Representative Today

TR150 Pixma Color Inkjet Printer w/Wireless Network

ITEM NO.
CNM4167C002

\$249⁹⁹

- Compact mobile design
- Up to 9 ipm black, 5.5 color
- Up to 4800 x 1200 dpi
- 4 x 6 photos in 53 seconds
- 50 sheet input tray
- 8.5" x 14" max paper size
- 1.44" OLED display



- Optional LK72 battery pack
- AirPrint, Mopria, Cloud apps
- USB, WiFi, PictBridge
- 12.7" x 7" x 3" / 4.5 lbs
- Uses: CLi36 series inks

MB2120 MAXIFY Color Inkjet Fax, Copier, Printer, Scanner w/Wireless Network and Duplex

ITEM NO.
CNM0959C002

\$229⁹⁹

- 33.6 Kbps / 100 speed dials
- Up to 19 ipm black, 13 color
- Up to 600 x 1200 dpi
- 250 sheet tray, 50 page ADF
- 8.5" x 11" platen; 14" paper
- 20,000 page duty cycle



- Automatic duplex copy/print
- 2.5" LCD, MAXIFY solutions
- AirPrint, Mopria, Cloud apps
- USB, Ethernet, WiFi (Win/Mac)
- 18" x 18" x 10.3" / 24 lbs
- Uses: PGI1200 series inks

TR8620 Pixma Color Inkjet Fax, Copier, Printer, Scanner w/Wireless Network and Duplex

ITEM NO.
CNM4451C002

\$261⁹⁹

- 33.6 Kbps / 250 page memory
- Up to 15 ipm black, 10 color
- Up to 4800 x 1200 dpi
- Two 100 sht trays, 20 pg ADF
- 8.5" x 11" platen; 14" paper
- Automatic duplex printing
- 4.3" color touch LCD



- AirPrint, Mopria, Cloud apps
- Bluetooth, WiFi Direct, RJ11
- USB, Ethernet, WiFi, SD
- 17" x 14" x 7.5" / 17.5 lbs
- PGI280, CLi281 series inks

MB5120 MAXIFY Color Inkjet Fax, Copier, Printer, Scanner w/Wireless Network and Duplex

ITEM NO.
CNM0960C002

\$355⁹⁹

- 33.6 Kbps / 100 speed dials
- Up to 24 ipm black, 15.5 color
- Up to 600 x 1200 dpi
- 250 sheet tray, 50 page ADF
- 8.5" x 11" platen; 14" paper
- 30,000 page duty cycle
- Full auto duplex fx/co/pt/sc
- 3.5" touch LCD, MAXIFY links



- AirPrint, Mopria, Cloud apps
- USB, Ethernet, WiFi (Win/Mac)
- 18" x 18" x 11.5" / 26 lbs
- Uses: PGI2200 series inks

TS9520 Color Inkjet Photo Copier, Printer, Scanner w/Wireless Network and Duplex

ITEM NO.
CNM2988C002

\$349⁹⁹

- Up to 15 ipm black, 10 color
- Up to 4800 x 1200 dpi
- 20 sheet 4 x 6 photo tray
- 100 sheet tray, 20 page ADF
- 8.5" x 11" platen; 14" tray
- 11" x 17" max bypass size
- Auto duplex print, AirPrint
- 4.3" touch LCD, quiet mode



- CD/DVD/Blu-ray Printing
- Mobile device, Mopria
- Google Cloud, Bluetooth
- USB, Ethernet, WiFi, PictB, SD
- 1 year limited warranty
- 18.5" x 14.5" x 7.6" / 21.3 lbs
- PGI280, CLi281 series ink

MB5420 MAXIFY Color Inkjet Fax, Copier, Printer, Scanner w/Wireless Network and Duplex

ITEM NO.
CNM0971C002

\$449⁹⁹

- 33.6 Kbps / 100 speed dials
- Up to 24 ipm black, 15.5 color
- Up to 600 x 1200 dpi
- (2) 250 sheet input trays
- 50 sheet DADF
- 8.5" x 11" platen; 14" paper
- 30,000 page duty cycle



- Full auto duplex fx/co/pt/sc
- 3.5" touch LCD, MAXIFY links
- AirPrint, Mopria, Cloud apps
- USB, Ethernet, WiFi (Win/Mac)
- 18.3" x 18" x 13.9" / 29 lbs
- Uses: PGI2200 series inks



NXT Premium is the NeXT Best Thing in Toner

Others keep telling you that buying and selling their recycled toner is to your advantage, but NXT Premium Replacement Cartridges are quality-tested, performance certified cartridges that offer a Lifetime Warranty.

- 100% lifetime warranty
- Certified performance (ISO/STMC)

- Reduce printing costs up to 50%
- High quality new components
- Expanded U.S. distribution

TS202 PIXMA Color Inkjet Photo Printer

ITEM NO.
CNM2319C002

\$59⁹⁹

- Up to 7.7 ipm black, 4 color
- Up to 4800 x 1200 dpi
- 20 sheet 4 x 6 photo tray
- 60 sheet input tray
- 8.5" x 11" max paper size
- Auto on/off, quiet mode



- My Image Garden, Photo print
- USB (Windows / Mac)
- 1 year limited warranty
- 16.8" x 8.5" x 4.9" / 6.4 lbs
- PG245, CL246 inks

TS302 PIXMA Color Inkjet Photo Printer w/Wireless Network

ITEM NO.
CNM2321C002

\$84⁹⁹

- Up to 7.7 ipm black, 4 color
- Up to 4800 x 1200 dpi
- 20 sheet 4 x 6 photo tray
- 60 sheet input tray
- 8.5" x 11" max paper size
- Mobile device, Mopria



- Google Cloud, Bluetooth
- USB, WiFi, PictB (Win/Mac)
- 1 year limited warranty
- 17" x 11.1" x 5.7" / 6.5 lbs
- PG245, CL246 inks

TS702 Pixma Color Inkjet Photo Printer w/Wireless Network

ITEM NO.
CNM3109C002

\$159⁰⁰

- Up to 15 ipm black, 10 color
- Up to 4800 x 1200 dpi
- 100 and 250 sheet trays
- 8.5" x 14" max paper size
- Automatic duplex printing
- Alexa, Google Assist support



- AirPrint, Mopria, Cloud apps
- PictBridge, Bluetooth
- USB, Ethernet, WiFi
- 1 year limited warranty
- 25" x 15" x 13" / 15 lbs
- PGi280, CLi281 series inks

iB4120 MAXIFY Color Inkjet Printer w/Wireless Network and Duplex

ITEM NO.
CNM0972C002

\$189⁰⁰

- Up to 24 ipm black, 15.5 color
- Up to 600 x 1200 dpi
- (2) 250 sheet input trays
- 8.5" x 14" max paper size
- 30,000 page duty cycle
- Automatic duplex printing
- MAXIFY print solutions



- AirPrint, Mopria, Cloud apps
- USB, Ethernet, WiFi (Win/Mac)
- 1 year limited warranty
- 18" x 18" x 11.5" / 21.5 lbs
- Uses: PGi2200 series inks

iX6820 Pixma Color Inkjet Business Printer w/Wireless Network

ITEM NO.
CNM8747B002

\$215⁰⁰

- Up to 14.5 ipm black, 10.4 color
- Up to 9600 x 2400 dpi
- 150 sheet input tray
- 13" x 19" max paper size
- Creative Park, Auto on/off
- Solution templates, AirPrint



- My Image Garden, HD movie
- Mobile device & Google Cloud
- USB, Ethernet, WiFi (Win/Mac)
- 1 year limited warranty
- 23" x 12" x 6" / 18 lbs
- PGi250, CLi251 series inks

iP8720 Pixma Color Inkjet Photo Printer w/Wireless Network

ITEM NO.
CNM8746B002

\$299⁰⁰

- Up to 14.5 ipm black, 10.4 color
- Up to 9600 x 2400 dpi
- 150 sheet input tray
- 13" x 19" max paper size
- Creative Park, AirPrint
- CD/DVD, Special Filters



- My Image Garden, HD movie
- Mobile device & Google Cloud
- USB, WiFi, PictB (Win/Mac)
- 1 year limited warranty
- 23" x 13" x 6" / 19 lbs
- PGi250, CLi251 series inks

FAXL100 Laser Fax, Copier, Printer

ITEM NO.
CNM5258B001

\$395⁰⁰

- 33.6 Kbps / 3 spp
- Up to 512 page memory
- 30 speed / 100 coded dials
- Up to 19 ppm / 12 cpm
- 150 sheet input tray
- 30 sheet ADF
- 8.5" x 14" max paper size



- 8,000 page duty cycle
- 64 MB, USB (Windows/Mac)
- 1 year limited warranty
- 14.7" x 12" x 12" / 20 lbs
- Uses: CNM128 toner

FAXL190 Laser Fax, Copier, Printer w/Duplex

ITEM NO.
CNM6356B002

\$449⁰⁰

- 33.6 Kbps / 3 spp
- Up to 512 page memory
- 40 speed / 200 coded dials
- Up to 26 cpm / ppm
- 250 sheet input tray
- 50 sheet DADF
- 8.5" x 14" max paper size



- 10,000 page duty cycle
- Auto duplex fax/copy/print
- 128 MB, USB (Windows/Mac)
- 1 year limited warranty
- 18.6" x 17.5" x 14" / 30 lbs
- Uses: CNM128 toner

Call Your Sales Representative Today

MF113W Laser Copier, Printer, Scanner w/Wireless Network

ITEM NO.
CNM2219C006

\$375⁰⁰



- Up to 23 cpm / ppm
- Up to 600 x 400 dpi
- 150 sheet input tray
- 8.5" x 11" platen, 14" paper
- 5 line LCD
- 1,500 page duty cycle
- AirPrint, Mopria, Cloud apps

- USB, Ethernet, WiFi
- 256 MB (Windows / Mac)
- 1 year limited warranty
- 15" x 13" x 10" / 33 lbs
- Uses: CNM047 toner

MF236N Laser Fax, Copier, Printer, Color Scanner w/Network

ITEM NO.
CNM1418C036

\$395⁰⁰



- 33.6 Kbps / 100 speed dials
- Up to 24 cpm / ppm
- Up to 1200 x 1200 dpi
- 250 sheet tray, 35 page ADF
- 8.5" x 11" platen; 14" paper
- 15,000 page duty cycle
- 256 MB, 6-line touch LCD
- Mobile device print and scan

- AirPrint, Mopria, Cloud apps
- USB, Ethernet (Win/Mac)
- 1 year limited warranty
- 15.4" x 14.7" x 14" / 27 lbs
- Uses: CNM137 toner

MF264DW Laser Copier, Printer, Scanner w/Wireless Network and Duplex

ITEM NO.
CNM2925C020

\$395⁰⁰



- Up to 30 cpm / ppm
- Up to 600 x 600 dpi
- 250 sheet tray, 35 page ADF
- 8.5" x 11" platen; 14" paper
- 2,500 page duty cycle
- Automatic duplex printing
- 5-line LCD, Mobile enabled

- AirPrint, Mopria, Cloud apps
- USB, Ethernet, WiFi
- 256 MB (Windows / Mac)
- 1 year limited warranty
- 15.4" x 16" x 14.8" / 27.3 lbs
- Uses: CNM051 toner

MF267DW Laser Fax, Copier, Printer, Scanner w/Wireless Network and Duplex

ITEM NO.
CNM2925C010

\$495⁰⁰



- 33.6 Kbps / 104 speed dials
- Up to 30 cpm / ppm
- Up to 600 x 600 dpi
- 250 sheet tray, 35 page ADF
- 8.5" x 11" platen; 14" paper
- 2,500 page duty cycle
- Automatic duplex printing
- 6-line touch LCD

- AirPrint, Mopria, Cloud apps
- USB, Ethernet, WiFi
- 256 MB (Windows / Mac)
- 1 year limited warranty
- 15.4" x 16" x 14.8" / 27.3 lbs
- Uses: CNM051 toner

MF269DW Laser Fax, Copier, Printer, Scanner w/Wireless Network and Duplex

ITEM NO.
CNM2925C006

\$595⁰⁰



- 33.6 Kbps / 104 speed dials
- Up to 30 cpm / ppm
- Up to 600 x 600 dpi
- 250 sheet tray, 50 page DADF
- 8.5" x 11" platen; 14" paper
- 2,500 page duty cycle
- Automatic duplex printing
- 6-line touch LCD

- AirPrint, Mopria, Cloud apps
- USB, Ethernet, WiFi
- 256 MB (Windows / Mac)
- 1 year limited warranty
- 15.4" x 16" x 14.8" / 29.3 lbs
- Uses: CNM051 toner

CNMMF269DWVP.....\$719.00

MF445DW Laser Fax, Copier, Printer, Scanner w/Wireless Network and Duplex

ITEM NO.
CNM3514C004

\$795⁰⁰



- 33.6 Kbps / 281 coded dials
- Up to 40 cpm / ppm
- Up to 600 x 600 dpi
- 100 and 250 sheet trays
- 50 sheet ADF
- 8.5" x 11" platen; 14" paper
- Full auto duplex fx/co/pt/sc
- 5" color touch panel

- AirPrint, Mopria, Cloud apps
- 2 USB, Ethernet, WiFi Direct
- 1 GB (Windows / Mac)
- 3 year limited warranty
- 17.9" x 18.3" x 15.5" / 35.8 lbs
- Uses: CNM057 toner

MF448DW Laser Fax, Copier, Printer, Scanner w/Wireless Network and Duplex

Authorization Required

ITEM NO.
CNM3514C003

\$995⁰⁰



- 33.6 Kbps / 281 coded dials
- Up to 40 cpm / ppm
- Up to 600 x 600 dpi
- 100 and 250 sheet trays
- 50 sheet ADF

- 8.5" x 14" platen / paper size
- Full auto duplex fx/co/pt/sc
- 5" color touch panel
- AirPrint, Mopria, Cloud apps
- 2 USB, Ethernet, WiFi Direct

- 1 GB (Windows / Mac)
- 1 year limited warranty
- 18" x 18" x 15.5" / 36 lbs
- Uses: CNM057 toner

ICD570 Laser Copier, Printer, Color Scanner
w/Network, Duplex and Wifi

ITEM NO.
CNM1418C025

\$445⁰⁰



- Up to 28 cpm / ppm
- Up to 600 x 600 dpi
- 250 sheet input tray
- 8.5" x 14" platen/paper size
- 15,000 page duty cycle
- Automatic duplex printing
- 5-line backlit LCD display

- Mopria, AirPrint
- USB, Ethernet, WiFi
- 512 MB (Windows/Mac)
- 1 year limited warranty
- 15.4" x 15" x 12.3" / 25 lbs
- Uses: CNM137 toner

MF644CDW Color Laser Copier, Printer, Scanner
w/Wireless Network and Duplex

ITEM NO.
CNM3102C002

\$529⁰⁰



- Up to 22 ppm black / color
- Up to 600 x 600 dpi
- 250 sheet tray, 50 page ADF
- 8.5" x 14" max paper size
- Automatic duplex printing
- 5" color touch LCD
- AirPrint, Mopria, Cloud apps

- 3 USB, Ethernet, WiFi Direct
- 1 GB (Windows / Mac)
- 3 year limited warranty
- 24" x 23" x 21" / 64 lbs
- Uses: CNM054 series toners

MF741CDW Color Laser Copier, Printer, Scanner
w/Wireless Network and Duplex

ITEM NO.
CNM3101C015

\$950⁰⁰



- Up to 28 cpm / ppm
- Up to 600 x 600 dpi
- 50 and 250 sheet trays
- 50 sheet ADF
- 8.5" x 14" max paper size
- Auto duplex copy/print/scan
- 5" color touch panel

- 4,000 page duty cycle
- AirPrint, Mopria, Cloud apps
- 3 USB, Ethernet, WiFi Direct
- 1 GB (Windows / Mac)
- 3 year limited warranty
- 19" x 19" x 18" / 76 lbs
- Uses: CNM055 series toners

MF743CDW Color Laser Fax, Copier, Printer, Scanner
w/Wireless Network and Duplex

ITEM NO.
CNM3101C011

\$1,029⁰⁰



- 33.6 Kbps / 281 coded dials
- Up to 28 cpm / ppm
- Up to 600 x 600 dpi
- 50 and 250 sheet trays
- 50 sheet ADF
- 8.5" x 11" platen, 14" paper size
- Full auto duplex fx/co/pt/sc
- 5" color touch panel

- AirPrint, Mopria, Cloud apps
- 3 USB, Gig Ethernet
- WiFi, WiFi Direct, NFC
- 1 GB (Windows / Mac)
- 3 year limited warranty
- 19" x 19" x 18" / 76 lbs
- Uses: CNM055 series toners

ICD1620 Laser Copier, Printer, Scanner
w/Wireless Network and Duplex

ITEM NO.
CNM2223C024

\$995⁰⁰



- Up to 45 cpm / ppm
- Up to 600 x 600 dpi
- 100 and 550 sheet trays
- 50 sheet DADF
- 8.5" x 14" platen/paper size
- 5" color touch panel
- Auto duplex copy/print/scan

- Mobile and Cloud apps
- USB, Ethernet, WiFi
- 1 GB (Windows / Mac)
- 3 year limited warranty
- 39" x 28" x 23" / 54 lbs
- Uses: CNM121 toner

ICD1650 Laser Fax, Copier, Printer, Scanner
w/Wireless Network and Duplex

ITEM NO.
CNM2223C023

\$1,195⁰⁰



- 33.6 Kbps / 281 coded dials
- Up to 45 cpm / ppm
- Up to 600 x 600 dpi
- 100 and 550 sheet trays
- 50 sheet DADF
- 8.5" x 14" platen/paper size
- 5" color touch panel
- Full auto duplex fx/co/pt/sc

- Mobile and Cloud apps
- USB, Ethernet, WiFi, NFC
- 1 GB (Windows / Mac)
- 1 year limited warranty
- 39" x 28" x 23" / 54 lbs
- Uses: CNM121 toner

MF810CDN Color Laser Fax, Copier, Printer, Scanner
w/Network and Duplex

ITEM NO.
CNM9548B001

\$1,995⁰⁰



- 33.6 Kbps / 300 coded dials
- Up to 26 cpm / ppm
- Up to 600 x 600 dpi
- 100 and 550 sheet trays
- 50 sheet DADF

- 8.5" x 14" platen/paper size
- 67,000 page duty cycle
- Full auto duplex fx/co/pt/sc
- 3.5" customize touch panel
- Airprint, Mopria, OCR scan

- USB, Gigabit Ethernet
- 1 GB (Windows / Mac)
- 1 year limited warranty
- 20" x 22" x 24" / 95 lbs
- Series 034 toners & drums

LBP6030W Laser Printer w/Wireless Network

ITEM NO.
CNM8468B003

\$315⁰⁰



- Up to 19 ppm
- Up to 2400 x 600 dpi
- 150 sheet input tray
- 8.5" x 14" max paper size
- 5,000 page duty cycle
- Mobile device enabled

- 32 Mb, USB, WiFi (Windows)
- 1 year limited warranty
- 14" x 9.8" x 7.8" / 12 lbs
- Uses: CNM125 toner

LBP113W Laser Printer w/Wireless Network

ITEM NO.
CNM2207C004

\$315⁰⁰



- Up to 23 ppm
- Up to 600 x 600 dpi
- 150 sheet input tray
- 8.5" x 14" max paper size
- 1,500 page duty cycle
- AirPrint, Mopria, Cloud apps

- USB, WiFi
- 256 MB (Windows / Mac)
- 1 year limited warranty
- 14.8" x 11.5" x 8.8" / 12.1 lbs
- Uses: CNM047 toner

LBP6230DW Laser Printer w/Wireless Network and Duplex

ITEM NO.
CNM9143B008

\$329⁰⁰



- Up to 26 ppm
- Up to 2400 x 600 dpi
- 250 sheet input tray
- 8.5" x 14" max paper size
- 8,000 page duty cycle
- Automatic duplex printing

- Mobile device enabled
- USB, Ethernet, WiFi
- 64 MB (Windows / Mac)
- 1 year limited warranty
- 14.9" x 11.5" x 9.6" / 16 lbs
- Uses: CNM126 toner

LBP162DW Laser Printer w/Wireless Network and Duplex

ITEM NO.
CNM2438C006

\$395⁰⁰



- Up to 30 ppm
- Up to 600 x 600 dpi
- 250 sheet input tray
- 8.5" x 14" max paper size
- 2,500 page duty cycle
- Automatic duplex printing

- AirPrint, Mopria, Cloud apps
- USB, Ethernet, WiFi
- 256 MB (Windows / Mac)
- 1 year limited warranty
- 14.9" x 16.2" x 9" / 15.4 lbs
- Uses: CNM051 toner

LBP622CDW Color Laser Printer w/Wireless Network and Duplex

ITEM NO.
CNM3104C005

\$550⁰⁰



- Up to 22 ppm black / color
- Up to 1200 x 1200 dpi
- 250 sheet input tray
- 8.5" x 14" max paper size
- 2,500 page duty cycle
- Automatic duplex printing

- AirPrint, Mopria, Cloud apps
- 3 USB, Ethernet, WiFi
- 1 GB (Windows / Mac)
- 1 year limited warranty
- 17" x 16.7" x 11.5" / 42 lbs
- Uses: CNM054 series toners

LBP226DW Laser Printer w/Wireless Network and Duplex

ITEM NO.
CNM3516C005

\$595⁰⁰



- Up to 40 ppm
- Up to 600 x 600 dpi
- 100 and 250 sheet trays
- 8.5" x 14" max paper size
- 4,000 page duty cycle
- Automatic duplex printing

- AirPrint, Mopria, Cloud apps
- 3 USB, Ethernet, WiFi Direct
- 1 GB (Windows / Mac)
- 1 year limited warranty
- 17" x 15" x 12" / 29 lbs
- Uses: CNM057 toner

LBP227DW Laser Printer w/Wireless Network and Duplex

ITEM NO.
CNM3516C004

\$599⁰⁰



- Up to 40 ppm
- Up to 600 x 600 dpi
- 100 and 250 sheet trays
- 8.5" x 14" max paper size
- 4,000 page duty cycle
- Automatic duplex printing
- AirPrint, Mopria, Cloud apps

- 3 USB, Ethernet, WiFi
- 1 GB (Windows / Mac)
- 1 year limited warranty
- 17" x 15" x 12" / 29 lbs
- Uses: CNM057 toner

LBP623CDW Color Laser Printer w/Wireless Network and Duplex

ITEM NO.
CNM3104C023

\$600⁰⁰



- Up to 22 ppm black / color
- Up to 600 x 600 dpi
- 250 sheet input tray
- 8.5" x 14" max paper size
- 5-line LCD / 2,500 page duty
- Automatic duplex printing
- AirPrint, Mopria, Cloud apps

- 3 USB, Ethernet, WiFi/direct
- 1 GB (Windows / Mac)
- 1 year limited warranty
- 17" x 16.8" x 11.5" / 35 lbs
- Uses: CNM054 series toners

LBP654CDW Color Laser Printer w/Wireless Network and Duplex

ITEM NO.
CNM1476C004

\$1,295⁰⁰



- Up to 21 ppm black / color
- Up to 1200 x 1200 dpi
- 50 and 250 sheet trays
- 8.5" x 14" max paper size
- 50,000 page duty cycle
- Automatic duplex printing
- AirPrint, Mopria, Cloud apps

- USB, Gigabit Ethernet, WiFi
- 1 GB (Windows / Mac)
- 1 year limited warranty
- 18.7" x 18.5" x 15" / 46.2 lbs
- Uses: CNM046 series toners

LBP712CDN Super Fast Color Laser Printer w/Network and Duplex

Authorization Required

ITEM NO.
CNM0656C002

\$1,795⁰⁰



- Up to 40 ppm black / color
- Up to 9600 x 600 dpi
- 100 and 550 sheet trays
- 8.5" x 14" max paper size
- 80,000 page duty cycle
- Automatic duplex printing
- UFR II, PCL5c/e & 6, PS

- AirPrint, Mopria, Cloud apps
- USB, Gigabit Ethernet
- 1 GB (Windows / Mac)
- 1 year limited warranty
- 18" x 18.3" x 15.3" / 63 lbs
- Uses: CNM040 series toners

LBP351DN High Speed Laser Printer w/Network and Duplex

Authorization Required

ITEM NO.
CNM0562C002

\$2,395⁰⁰



- Up to 58 ppm
- Up to 1200 x 1200 dpi
- 100 and 500 sheet trays
- 8.5" x 14" max paper size
- 250,000 page duty cycle
- Automatic duplex printing
- PCL5c/e & 6, PS, PDF, XPS

- AirPrint, Mopria, Cloud apps
- USB, Gigabit Ethernet
- 1 GB (Windows / Mac)
- 1 year limited warranty
- 16.4" x 20.9" x 17" / 58 lbs
- Uses: CNM039 toner

LBP352DN High Speed Laser Printer w/Network and Duplex

Authorization Required

ITEM NO.
CNM0562C007

\$3,395⁰⁰



- Up to 65 ppm
- Up to 1200 x 1200 dpi
- 100 and 500 sheet trays
- 8.5" x 14" max paper size
- 280,000 page duty cycle
- Automatic duplex printing
- UFR II, PCL 5/6, PDF, XPS

- USB, Gig Ethernet
- 1 GB (Windows / Mac)
- 1 year limited warranty
- 21" x 17" x 16" / 58 lbs
- Uses: CNM039 toner



imageCLASS

Canon Laser Printers in Education

Canon laser printers are utilized in virtually any education setting, from early child education to school districts to universities and more. Canon equipment facilitates learning so educators and families can effectively contribute to student development at all ages.



Call Your Sales Representative Today

LIDE300 *CanoScan Color Image Scanner*

ITEM NO.
CNM2995C002

\$89⁰⁰



- Flatbed design, CIS sensor
- 4 EZ button control panel
- Auto scan, copy, PDF, send
- Z-Lid expands for thick media
- Up to 2400 x 2400 dpi
- 8.5" x 11.7" max scan size

- Document fix, digital filing
- Fade, grain, shadow correction
- One button Send to Cloud
- USB (Windows / Mac)
- 1 year limited warranty
- 9.9" x 14.5" x 1.7" / 3.6 lbs

LIDE400 *CanoScan Color Image Scanner*

ITEM NO.
CNM2996C002

\$115⁰⁰



- Flatbed design, CIS sensor
- 5 EZ button control panel
- Auto scan, copy, PDF, send
- Advanced Z-lid expansion top
- Up to 4800 x 4800 dpi
- 8" x 11.7" max scan size

- Auto dust/scratch reduction
- Fade, grain, shadow correction
- One button send to Cloud
- USB Type-C (Win/Mac)
- 1 year limited warranty
- 15" x 10" x 2" / 4 lbs

P-208II *imageFORMULA Scan-tini Personal Document Scanner*

ITEM NO.
CNM9704B007

\$249⁰⁰



- Upright design, CMOS sensor
- 10 sheet top-feed w/eject
- Up to 8 ppm, duplex scan
- Plastic or embossed cards
- U-turn or straight path feed
- 118" long document mode

- Auto resolution, Cloud apps
- Ultra double feed detection
- CaptureOnTouch (Windows)
- USB, ISIS/TWAIN drivers
- 1 year limited warranty
- 1.5" x 12.3" x 2.2" / 1.3 lbs

P-215II *imageFORMULA Scan-tini Personal Document Scanner*

ITEM NO.
CNM9705B007

\$369⁰⁰



- Upright design, CMOS sensor
- 20 sheet top-feed w/eject
- Up to 10 ppm, duplex scan
- Plastic or embossed cards
- U-turn or straight path feed
- 118" long document mode

- Auto resolution, Cloud apps
- Ultra double feed detection
- CaptureOnTouch (Windows)
- USB, ISIS/TWAIN drivers
- 1 year limited warranty
- 1.5" x 12.3" x 2.2" / 1.3 lbs

DR-F120 *imageFORMULA Universal Office Document Scanner*

ITEM NO.
CNM9017B002

\$569⁰⁰



- Flatbed w/50 sheet ADF
- Single pass duplex scanning
- Up to 20 ppm black or color
- Plastic or embossed cards
- 800 page daily volume
- 39.4" long document mode

- Auto color, page size, deskew
- Ultra double feed detection
- Capture OnTouch, Cloud apps
- USB, ISIS/TWAIN drivers
- 3 year limited warranty
- 13" x 18.5" x 4.7" / 10 lbs

DR-C225II *imageFORMULA Office Document Scanner*

ITEM NO.
CNM3258002

\$579⁰⁰



- Upright design, CMOS sensor
- 30 sheet topfeed w/eject
- Up to 25 ppm, duplex scan
- Plastic or embossed cards
- U-turn or straight path feed
- 118" long document mode

- Auto resolution, Cloud apps
- Ultra double feed detection
- CaptureOnTouch (Windows)
- USB, ISIS/TWAIN drivers
- 3 year limited warranty
- 12" x 9" x 6" / 6 lbs

CNM3259002 (DR-C225WII)\$699.00

DR-C230 *imageFORMULA Office Document Scanner*

ITEM NO.
CNM2646C002

\$629⁰⁰



- Upright design, CMOS sensor
- 60 sheet top feed w/eject
- Up to 30 ppm, duplex scan
- Plastic or embossed cards
- U-turn or straight path feed
- 118" long document mode

- Auto resolution, Cloud apps
- Ultra double feed detection
- CaptureOnTouch (Windows)
- USB, ISIS/TWAIN drivers
- 3 year limited warranty
- 9" x 11.5" x 10" / 6.17 lbs

DR-C240 *imageFORMULA Office Document Scanner w/Duplex*

ITEM NO.
CNM0651C002

\$989⁰⁰



- 60 sheet top-feed design
- Up to 45 ppm B&W, 20 color
- Duplex scan 90 ipm, 60 color
- 4,000 scans duty cycle
- Plastic or embossed cards
- Ultra double feed detection

- Automatic image correction
- Crop, skip, text/color enhance
- CaptureOnTouch, OCR
- USB (Windows / MacOS)
- 1 year limited warranty
- 11.4" x 9.9" x 9" / 6.2 lbs

DR-M140 *imageFORMULA Office Document Scanner*

ITEM NO.
CNM5482B002

\$1,295⁰⁰



- U-turn or straight path feed
- 50 sheet ADF
- Up to 40 ppm, duplex scan
- 9 scan task control panel
- Robust 6,000 scan daily volume
- 118" long document mode

- Auto color, size, resolution
- Ultra double feed detection
- Capture OnTouch & Perfect
- USB, ISIS/TWAIN drivers
- 1 year limited warranty
- 12.3" x 7" x 3.7" / 5.7 lbs

DR-M160II *imageFORMULA Office Document Scanner*

ITEM NO.
CNM0114T279

\$1,395⁰⁰



- Mixed batch 60 sheet ADF
- Single pass duplex scanning
- Up to 60 ppm black or color
- One-touch LED control panel
- Character emphasis & OCR
- Auto color, size, resolution

- 7,000 daily scans, cloud apps
- Capture OnTouch & Perfect
- Integrate w/third party ECM
- USB (Windows / Mac)
- 1 year limited warranty
- 11" x 9" x 9.8" / 7 lbs

DR-M260 *imageFORMULA Office Document Scanner*

ITEM NO.
CNM2405C002

\$1,445⁰⁰



- LCD display, CMOS sensor
- 80 sheet auto feeder
- Up to 60 ppm, black/color
- Duplex scan at 120 ipm
- 7,500 pages daily volume
- Preprogram up to 99 jobs

- Custom resolution option
- 220" long document mode
- Ultra double feed detection
- USB, CaptureOnTouch
- 5 year limited warranty
- 11.2" x 10" x 9.9" / 7.5 lbs

DR-M1060 *imageFORMULA Office Document Scanner*

ITEM NO.
CNM9396B002

\$2,575⁰⁰



- U-turn or straight path feed
- 600 dpi, 24 bit color depth
- Up to 60 ppm, color/grayscale
- Duplex scan at 120 ipm
- 11.8" x 17" max scan size
- Plastic or embossed cards

- 7,500 pages daily volume
- MultiStream mode
- Capture OnTouch & Perfect
- USB, ISIS/TWAIN drivers
- 1 year limited warranty
- 16.7" x 9.7" x 4.7" / 13.5 lbs

DR-6010C *imageFORMULA High-Speed Departmental Scanner*

ITEM NO.
CNM3801B002

\$3,460⁰⁰



- 100 sheet ADF & eject trays
- Three-line CIS sensor, 600 dpi
- Up to 60 ppm, duplex scan
- U-turn or straight path feed
- Plastic, fragile or thick media
- Three text enhancement modes

- Auto color, size, resolution
- Ultra double feed detection
- CapturePerfect & Kofax
- USB, ISIS/TWAIN drivers
- 1 year limited warranty
- 12.5" x 10.9" x 7.3" / 14 lbs

DR-6030C *imageFORMULA High-Speed Departmental Scanner*

ITEM NO.
CNM4624B002

\$4,740⁰⁰



- High volume 100 sheet ADF
- Up to 80 ppm or 160 images
- Duplex scan, MultiStream
- U-turn or straight path feed
- Up to 100 sets scan preferences
- 10,000 page daily duty cycle

- Custom color correct, dropout
- Ultra double feed detection
- CapturePerfect & Kofax
- USB, ISIS/TWAIN drivers
- 1 year limited warranty
- 15.6" x 12.3" x 7.5" / 23 lbs

DR-G2110 *imageFORMULA Production Document Scanner*

ITEM NO.
CNM3150C002

\$7,169⁰⁰



- Efficient, high-volume scanning
- Up to 110 ppm color/grayscale
- Single-pass duplex, 220 ipm
- 500 sheet ADF, 600 dpi

- 12" x 220" max scan size
- Up to 50,000 pages daily
- Double-feed & staple detection
- Programmable job buttons

- MultiStream, Color correction
- Kovak VRS, CaptureOnTouch
- USB, Ethernet (Windows)
- ISIS and TWAIN drivers
- 22.4" x 19" x 12.4" / 55 lbs

Call Your Sales Representative Today



Success enabled

Grow your capabilities. Grow your business.



Productivity. Reliability. Value.

Intelligent new Lexmark color family of printers and MFPs take your productivity to a whole new level.

CS-308ci Color Digital Copier, Printer, Scanner w/Network and Duplex

ITEM NO.

COY1102WL2CS0

\$4,552⁰⁰



*Shown w/ Options



- Up to 32 ppm black or color
- Up to 1200 x 1200 dpi
- 100 and 500 sheet trays
- 75 page RADF
- 8.5" x 14" platen; 36" paper
- 100,000 page duty cycle
- Auto duplex copy/print/scan

- 7" color touch screen
- AirPrint, Mopria, Cloud apps
- 3 USB, Gig Ethernet, 2 EIO
- 1.5 GB (Windows / Mac)
- 3 year parts only warranty
- 29" x 21.7" x 20" / 109 lbs
- Uses: TK5199x series toners

CS-358ci Color Digital Copier, Printer, Scanner w/Network and Hard Disk Drive

ITEM NO.

COY1102V42CS0

\$6,757⁰⁰



*Shown w/ Options



- Up to 37 ppm black or color
- Up to 1200 x 1200 dpi
- 100 and 500 sheet trays
- Optional doc processors
- 8.5" x 14" platen; 48" paper
- 100,000 page duty cycle
- 7" color touch screen

- AirPrint, Mopria, Cloud apps
- 4 USB, Gig Ethernet, 2 EIO
- 4 GB, 320GB HDD (Win / Mac)
- 3 year parts only warranty
- 29" x 21.7" x 20" / 106 lbs
- Uses: TK52079 series toners

CS-408ci Color Digital Copier, Printer, Scanner w/Network and Duplex

ITEM NO.

COY1102R62CS0

\$8,136⁰⁰



*Shown w/ Options



- Up to 42 ppm black or color
- Up to 9600 x 600 dpi
- 100 and 500 sheet trays
- 8.5" x 14" platen/paper size
- 150,000 page duty cycle
- Auto duplex copy/print/scan
- 7" color tablet-like screen

- AirPrint, KYOCERA print
- 2 GB, 4 USB, Gig Ethernet, 2 EIO
- 320 GB HDD (Windows / Mac)
- 3 year parts only warranty
- 21.7" x 20" x 24" / 102 lbs
- Uses: TK5219x series toners

CS-508ci Digital Copier, Printer, Color Scanner w/Network and Duplex

ITEM NO.

COY1102V62CS0

\$8,537⁰⁰



*Shown w/ Options



- Up to 40 cpm / ppm
- Up to 1200 x 1200 dpi
- 100 and (2) 500 sheet trays
- 11" x 17" platen/paper size
- 165,000 page duty cycle
- Auto duplex copy/print/scan
- 9" color touch screen
- AirPrint, KYOCERA, Cloud apps

- NFC & WiFi direct support
- 5 USB, Gig Ethernet, 2 EIO
- 2GB, 8GB SSD & 320GB HDD
- 3 year parts only warranty
- 23.4" x 27.4" x 26.8" / 131 lbs
- Uses: KYOTK7209 toner
- MK7127 maintenance kit

CS-2553ci Color Digital Copier, Printer, Scanner w/Network and Duplex

ITEM NO.

COY1102VH72CS0

\$8,110⁰⁰



*Shown w/ Options



- Portfolio of Business Apps
- Up to 25 ppm black or color
- Up to 1200 x 1200 dpi
- 150 and (2) 500 sheet trays
- 11" x 17" platen size
- 12" x 18" trays, 48" max paper
- 100,000 page duty cycle
- Auto duplex copy/print/scan

- 10.1" color tablet-like screen
- AirPrint, Kyocera, Cloud apps
- 4 GB, 4 USB, Gig Ethernet, 2 EIO
- 320 GB HDD (Windows / Mac)
- 3 year parts only warranty
- 23.7" x 26" x 31" / 203 lbs
- Uses: TK8349x series toners

CS-3212i Digital Copier, Printer, Color Scanner w/Network and Duplex

ITEM NO.

COY1102V72CS0

\$6,209⁰⁰



*Shown w/ Options



- Up to 32 cpm / ppm
- Up to 1200 x 1200 dpi
- 100 and (2) 500 sheet trays
- 11" x 17" platen/paper size
- 150,000 page duty cycle
- Auto duplex copy/print/scan
- 9" color touch screen
- AirPrint, KYOCERA, Cloud apps

- NFC & WiFi direct support
- 5 USB, Gig Ethernet, 2 EIO
- 2GB, 8GB SSD & 320GB HDD
- 3 year parts only warranty
- 23.4" x 27.4" x 26.8" / 130 lbs
- Uses: KYOTK7129 toner
- MK7127 maintenance kit

COPYSTAR ACCESSORIES

Item Code	Item Description	Fits Model	Yield	List
COY1T02R40CS0	TK-5199 standard black toner	308ci	15,000	\$99.00
COY1T02R4CCSO	TK-5199 standard cyan toner	308ci	7,000	\$129.00
COY1T02R4BCSO	TK-5199 standard magenta toner	308ci	7,000	\$129.00
COY1T02R4ACSO	TK-5199 standard yellow toner	308ci	7,000	\$129.00
COY1702WL7US0	MK-5357A maintenance kit (drum, developer, fuser, transfer)	308ci	200,000	\$865.00
COY1702R40UNO	MK-5195B maintenance kit (3 drums, 3 dev units)	308ci	200,000	\$1,099.00
KY01T02R50CS0	TK-5209 standard black toner	358ci	18,000	\$99.95
KY01T02R5CCSO	TK-5209 standard cyan toner	358ci	12,000	\$109.95
KY01T02R5BCSO	TK-5209 standard magenta toner	358ci	12,000	\$109.95
KY01T02R5ACSO	TK-5209 standard yellow toner	358ci	12,000	\$109.95
COY1702V47US1	MK-5367A maintenance kit (drum, developer, fuser, transfer)	358ci	200,000	\$865.00
COY1702R50UNO	MK-5205B maintenance kit (3 drums, 3 dev units)	358ci	200,000	\$1,299.00

COPYSTAR ACCESSORIES

<i>Item Code</i>	<i>Item Description</i>	<i>Fits Model</i>	<i>Yield</i>	<i>List</i>
KYO1T02WHOCSO	TK-5319 standard black toner	408, 508	24,000	\$119.00
KYO1T02WHCCSO	TK-5319 standard cyan toner	408, 508	18,000	\$170.20
KYO1T02WHBCSO	TK-5319 standard magenta toner	408, 508	18,000	\$170.20
KYO1T02WHACSO	TK-5319 standard yellow toner	408, 508	18,000	\$170.20
COY1702WH7USO	MK-5347A maintenance kit (drum, developer, fuser, transfer)	408, 508	300,000	\$1,099.00
COY1702WHOKLO	MK-5225B maintenance kit (3 drums, 3 dev units)	408, 508	300,000	\$1,899.00
COY1902R60UNO	WT-5190 waste disposal unit	308, 358, 408, 508	44,000	\$29.00
COY1902R60UN1	DT-5100 platen cover	308, 358, 408, 508		\$54.00
COY1203PS7USO	PF-5120 500 sheet paper drawer	308, 358, 408, 508		\$451.00
COY1203PZ7USO	PF-5130 Dual 500 sheet paper drawers	308, 358, 408, 508		\$1,287.00
COY1203PT7USO	PF-5140 2,000 sheet paper drawer	308, 358, 408, 508		\$1,380.00
COY855D200715	12.5" copier stand	358, 408, 508		\$250.00
KYO1503R22US1	Fax system 10X	358, 408, 508		\$840.00
COY1203R36USO	DP-5100 (75 sheet) reversing auto doc processor	358, 408, 508		\$1,417.00
COY1203SK6USO	DP-5120 (100 sheet) dual scan auto doc processor	358, 408, 508		\$1,544.00
COY1203T26USO	DP-5130 (270 sheet) dual scan auto doc processor	358, 408, 508		\$2,375.00
COY1T02L70CSO	TK-8349 standard black toner	2553	20,000	\$139.00
COY1T02L7CCSO	TK-8349 standard cyan toner	2553	12,000	\$129.00
COY1T02L7BCSO	TK-8349 standard magenta toner	2553	12,000	\$129.00
COY1T02L7ACSO	TK-8349 standard yellow toner	2553	12,000	\$129.00
COY1702RLOUN3	MK-8335A maintenance kit (black drum)	2553	200,000	\$199.00
COY1702RLOUNO	MK-8335B maintenance kit (3 color drums)	2553	200,000	\$699.00
COY1702RLOUN1	MK-8335D maintenance kit (drum, developer, fuser, transfer)	2553	600,000	\$1,799.00
COY1702RLOUN2	MK-8335E maintenance kit (3 dev)	2553	600,000	\$439.00
KYO1902NDOUNO	WT-8500 waste toner container	2553		\$25.00
COY1203RB2USO	PF-7100 Dual 500 sheet paper drawers-Ledger	2553		\$1,287.00
COY1203RC2USO	PF-7110 Dual 1,500 sheet paper drawers-Letter	2553		\$1,380.00
COY1203RL2USO	PF-7120 3,000 sheet side paper drawer-Letter	2553		\$1,417.00
COY1T02V70CSO	TK-7129 standard black toner	3212	20,000	\$104.00
COY1702V67USO	MK-7127 maintenance kit (drum, developer, fuser, transfer)	3212	600,000	\$815.00
COY1203RJ7USO	PF-791 Dual 500 sheet paper drawers-Ledger	3212		\$1,287.00
COY1203PC7USO	PF-810 Dual 1,500 sheet paper drawers-Letter	3212		\$1,380.00
COY855D200656	13" copier stand	3212		\$286.00
COY1203RJ6USO	DP-7120 (50 sheet) reversing auto doc processor	2553, 3212		\$1,133.00
COY1203R76USO	DP-7100 (140 sheet) reversing auto doc processor	2553, 3212		\$1,417.00
COY1203R86USO	DP-7110 (270 sheet) dual scan auto doc processor	2553, 3212		\$1,800.00
KYO1503RK2USJ	Fax system 12	2553, 3212		\$840.00
COY1703MCOUNO	Internet fax kit A	358, 408, 508, 2553, 3212		\$300.00
COY1505J5OUNO	IB-51 wireless NIC card	358, 2553, 3212		\$554.00

M2040dn Laser Copier, Printer, Color Scanner
w/Network and Duplex

ITEM NO.
KYO1102S32US0

\$1,181⁰⁰



- Up to 42 cpm / ppm
- Up to 600 x 600 dpi
- 100 and 250 sheet trays
- 50 sheet DSDP
- 8.5" x 14" platen/paper size
- 50,000 page duty cycle
- Auto duplex copy/print/scan

- Mobile print enabled
- USB, Gigabit Ethernet
- 512 MB RAM (Windows / Mac)
- 1 year limited warranty
- 18.7" x 16.2" x 17.2" / 42 lbs
- Uses: KYOTK1172 toner
- MK1152 maintenance kit

M2540dw Laser Fax, Copier, Printer, Color Scanner
w/Wireless Network and Duplex

ITEM NO.
KYO1102S42US0

\$1,371⁰⁰



- 33.6 Kbps
- Up to 42 cpm / ppm
- Up to 1200 dpi
- 100 and 250 sheet trays
- 50 sheet DSDP
- 8.5" x 14" platen/paper size
- 50,000 page duty cycle
- Full auto duplex fx/co/pt/sc

- Business apps; mobile print
- 2 USB, Gigabit Ethernet, WiFi
- 512 MB RAM (Windows / Mac)
- 1 year limited warranty
- 19.4" x 16.9" x 17.6" / 40 lbs
- Uses: KYOTK1172 toner
- MK1152 maintenance kit

M2635dw Laser Fax, Copier, Printer, Color Scanner
w/Wireless Network and Duplex

ITEM NO.
KYO1102S22US0

\$816⁰⁰



- 33.6 Kbps
- Up to 37 cpm / ppm
- Up to 1200 dpi
- 100 and 250 sheet trays
- 50 sheet ADF
- 8.5" x 14" platen/paper size
- 20,000 page duty cycle
- Full auto duplex fx/co/pt/sc

- Business apps; mobile print
- 2 USB, Gigabit Ethernet, WiFi
- 512 MB RAM (Windows / Mac)
- 1 year limited warranty
- 19.4" x 16.9" x 17.6" / 40 lbs
- Uses: KYOTK1152 toner
- MK1152 maintenance kit

M2640idw Laser Fax, Copier, Printer, Color Scanner
w/Wireless Network and Duplex

ITEM NO.
KYO1102S52US0

\$1,567⁰⁰



- HyPAS business app capable
- 33.6 Kbps
- Up to 42 cpm / ppm
- Up to 1200 dpi
- 100 and 250 sheet trays
- 50 sheet DSDP
- 8.5" x 14" platen/paper size
- 50,000 page duty cycle

- Full auto duplex fx/co/pt/sc
- Mobile device enabled
- 2 USB, Gigabit Ethernet, WiFi
- 512 MB RAM (Windows / Mac)
- 1 year limited warranty
- 18.7" x 16.2" x 17.2" / 42 lbs
- Uses: KYOTK1172 toner
- MK1152 maintenance kit

M3145idn Laser Copier, Printer, Color Scanner
w/Network and Duplex

ITEM NO.
KYO1102V22US0

\$2,459⁰⁰



- Up to 47 cpm / ppm
- Up to 1200 x 1200 dpi
- 100 and 500 sheet trays
- 75 sheet RADF
- 8.5" x 11" platen; 14" paper
- 150,000 page duty cycle
- Auto duplex copy/print/scan
- 7" color touch screen

- Mobile print enabled
- 2 USB, Gig Ethernet, EIO
- 1 GB (Windows / Mac)
- 1 year limited warranty
- 18.7" x 18.7" x 22.6" / 49.6 lbs
- Uses: KYOTK3162 toner

M3645idn Laser Fax, Copier, Printer, Color Scanner
w/Network and Duplex

ITEM NO.
KYO1102V32US0

\$2,799⁰⁰



- 33.6 Kbps
- Up to 47 cpm / ppm
- Up to 1200 x 1200 dpi
- 100 and 500 sheet trays
- 75 sheet RADF
- 8.5" x 11" platen; 14" paper
- 150,000 page duty cycle
- Full auto duplex fx/co/pt/sc

- 7" color touch screen
- 2 USB, Gig Ethernet, EIO
- 1 GB (Windows / Mac)
- 1 year limited warranty
- 18.7" x 18.7" x 22.6" / 49.6 lbs
- Uses: KYOTK3162 toner

M3655idn Laser Fax, Copier, Printer, Color Scanner
w/Network and Duplex

ITEM NO.
KYO1102TB2US0

\$3,389⁰⁰



- 33.6 Kbps
- Up to 57 cpm / ppm
- Up to 1200 x 1200 dpi
- 100 and 500 sheet trays
- 100 sheet DSDP

- 8.5" x 14" platen/paper size
- 250,000 page duty cycle
- Full auto duplex fx/co/pt/sc
- 7" color touch screen
- Mobile print enabled

- 2 USB, Gig Ethernet, EIO
- 1 GB (Windows / Mac)
- 1 year limited warranty
- 18.9" x 19.5" x 23.2" / 53.1 lbs
- Uses: KYOTK3182 toner

M3860idn Laser Fax, Copier, Printer, Color Scanner w/Network and Duplex

ITEM NO.
KYO1102X92US0

\$5,687⁰⁰



- HyPAS business app capable
- 33.6 Kbps
- Up to 62 cpm / ppm
- Up to 1200 x 1200 dpi
- 100 and 500 sheet trays
- 100 sheet DSDP
- 8.5" x 14" platen/paper size
- 300,000 page duty cycle

- Full auto duplex fx/co/pt/sc
- 7" color touch screen
- Mobile print enabled
- 3 USB, Gig Ethernet, EIO
- 1 GB (Windows / Mac)
- 24" x 19.5" x 19" / 54 lbs
- Uses: KYOTK3302 toner

M3860idnf Laser Fax, Copier, Printer, Color Scanner w/Network, Duplex and Finisher

ITEM NO.
KYO1102WF2US0

\$8,123⁰⁰



- HyPAS business app capable
- 33.6 Kbps
- Up to 62 cpm / ppm
- Up to 1200 x 1200 dpi
- 100 and 500 sheet trays
- 100 sheet DSDP
- 250 sheet internal finisher
- Auto staple 50 sheets
- 8.5" x 14" platen/paper size

- 300,000 page duty cycle
- Full auto duplex fx/co/pt/sc
- 7" color touch screen
- Mobile print enabled
- 3 USB, Gig Ethernet, EIO
- 1 GB (Windows / Mac)
- 29" x 22" x 19" / 80.5 lbs
- Uses: KYOTK3302 toner

KYOCERA ACCESSORIES

Item Code	Item Description	Fits Model	Yield	List
KYO1T02S50US0	TK-1172 standard black toner	2040, 2540, 2640	7,200	\$86.00
KYO1T02RV0US0	TK-1152 standard black toner	2635	3,000	\$68.33
KYO1702RV0US0	MK-1152 maintenance kit (drum, dev units)	2040, 2540, 2635, 2640	100,000	\$182.00
COY1203RA0UN0	PF-1100 250 sheet paper drawer-Legal	2040, 2540, 2635, 2640		\$130.00
COY855D200756	13" copier stand	2040, 2540, 2635, 2640		\$285.00
KYO1T02T90US0	TK-3162 standard black toner	3145, 3645	12,500	\$105.00
KYO1702V37US0	MK-3262 maintenance kit (drum, dev, fuser, feed, retard, transfer roller)	3145, 3645	300,000	\$280.00
KYO1702P60UN0	MK-3140 document processor maintenance kit	3145, 3645	200,000	\$102.00
KYO1T02T70US0	TK-3182 standard black toner	3655	21,000	\$97.00
KYO1T02T60US0	TK-3192 standard black toner	3860	25,000	\$105.00
KYO1T02WF0US0	TK-3202 high black toner	3860	45,000	\$153.85
KYO1702TA7US0	MK-3302 maintenance kit (drum, dev, fuser, feed, retard, transfer roller)	3655, 3860	500,000	\$283.00
KYO1703R40UN0	MK-5200 document processor maintenance kit	3655, 3860	200,000	\$73.00
KYO1203SA0KLO	PF-3110 500 sheet paper drawer-Legal	3145, 3645, 3655, 3860		\$249.00
COY855D200655	25" copier stand	3145, 3645, 3655, 3860		\$319.00
COY1503S50UN0	IB-36 wireless interface card	3145, 3645, 3655, 3860		\$142.00
COY1505J50UN0	IB-51 wireless interface card	3145, 3645, 3655, 3860		\$554.00

M4125idn Laser Copier, Printer, Color Scanner
w/Network and Duplex

ITEM NO.
KYO1102P22US0

\$4,679⁰⁰



*Shown w/
Options



- Up to 25 cpm / ppm
- Up to 1200 dpi
- 100 and 500 sheet trays
- 50 sheet RADP
- 11" x 17" platen/paper size
- 80,000 page duty cycle
- Auto duplex copy/print/scan
- 4.3" color touch screen

- Mobile print enabled
- 3 USB, Gig Ethernet, 2 EIO
- 1 GB (Windows / Mac)
- 1 year limited warranty
- 23.2" x 23.2" x 27.1" / 108 lbs
- Uses: KYOTK6117 toner

KYO1102P12US0 (M4132idn) **\$5,879.00**

M5521cdw Color Laser Fax, Copier, Printer, Scanner
w/Wireless Network and Duplex

ITEM NO.
KYO1102R92US0

\$1,365⁰⁰



- 33.6 Kbps / 100 speed dials
- Up to 22 ppm black or color
- Up to 1200 x 1200 dpi
- 50 and 250 sheet trays
- 50 sheet DADF
- 8.5" x 11" platen; 14" paper
- 65,000 page duty cycle
- Full auto duplex fx/co/pt/sc

- KYOCERA Mobile, AirPrint
- Mopria, Cloud, WiFi direct
- 2 USB, Gig Ethernet, WiFi
- 512 MB (Windows / Mac)
- 1 year limited warranty
- 16.4" x 16.9" x 19.5" / 57 lbs
- Uses: TK5222 series toners

M5526cdw Color Laser Fax, Copier, Printer, Scanner
w/Wireless Network and Duplex

ITEM NO.
KYO1102R72US0

\$1,909⁰⁰



- 33.6 Kbps / 100 speed dials
- Up to 27 ppm black or color
- Up to 1200 x 1200 dpi
- 50 and 250 sheet trays
- 50 sheet DADF
- 8.5" x 11" platen; 14" paper
- 65,000 page duty cycle
- 4.3" color touch screen
- Full auto duplex fx/co/pt/sc

- KYOCERA Mobile, AirPrint
- Mopria, Cloud, WiFi direct
- 2 USB, Gig Ethernet, WiFi
- 512 MB (Windows / Mac)
- 1 year limited warranty
- 16.4" x 16.9" x 19.5" / 57 lbs
- Uses: TK5242 series toners

M6630cidn Color Laser Fax, Copier, Printer,
Color Scanner w/Network and Duplex

ITEM NO.
KYO1102T22US1

\$3,999⁰⁰



- 33.6 Kbps
- Up to 32 ppm black or color
- Up to 9600 x 600 dpi
- 100 and 250 sheet trays
- 75 sheet RADF
- 8.5" x 14" platen/paper size
- 100,000 page duty cycle
- Full auto duplex fx/co/pt/sc

- 7" color touch screen
- Mobile print enabled
- 2 USB, Gig Ethernet, EIO
- 1 GB (Windows / Mac)
- 1 year limited warranty
- 18.7" x 22" x 24.3" / 106 lbs
- Uses: TK5272x series toners

M6235cidn Color Laser Copier, Printer, Color
Scanner w/Network and Duplex

ITEM NO.
KYO1102V02US1

\$4,209⁰⁰



- Up to 37 ppm black or color
- Up to 9600 x 600 dpi
- 100 and 250 sheet trays
- 100 sheet DSDP
- 8.5" x 14" platen/paper size
- 100,000 page duty cycle
- Auto duplex copy/print/scan

- 7" color touch screen
- Mobile print enabled
- 2 USB, Gig Ethernet, EIO
- 1 GB (Windows / Mac)
- 1 year limited warranty
- 18.9" x 22.7" x 24.4" / 80.3 lbs
- Uses: TK5282x series toners

M6635cidn Color Laser Fax, Copier, Printer, Color
Scanner w/Network and Duplex

ITEM NO.
KYO1102V12US1

\$4,799⁰⁰



- 33.6 Kbps
- Up to 37 ppm black or color
- Up to 9600 x 600 dpi
- 100 and 250 sheet trays
- 100 sheet DSDP
- 8.5" x 14" platen/paper size
- 100,000 page duty cycle
- Full auto duplex fx/co/pt/sc

- 7" color touch screen
- Mobile print enabled
- 2 USB, Gig Ethernet, EIO
- 1 GB (Windows / Mac)
- 1 year limited warranty
- 18.9" x 22.7" x 24.4" / 108 lbs
- Uses: TK5282x series toners

M8124cidn Color Laser Copier, Printer, Color
Scanner w/Network and Duplex

ITEM NO.
KYO1102P43NLO

\$7,149⁰⁰



*Shown w/
Options



- Up to 24 ppm black or color
- Up to 1200 x 1200 dpi
- 100 and 500 sheet trays
- 50 sheet RADP
- 11" x 17" platen/paper size
- 100,000 page duty cycle
- Auto duplex copy/print/scan

- 4.3" color touch screen
- Mobile print enabled
- 3 USB, Gig Ethernet, 2 EIO
- 1.5 GB (Windows / Mac)
- 1 year limited warranty
- 23.2" x 23.2" x 29.6" / 168 lbs
- Uses: TK8117x series toners

M8130cidn Color Laser Copier, Printer, Color
Scanner w/Network and Duplex

ITEM NO.
KYO1102P32US0

\$8,259⁰⁰



*Shown w/
Options



- Up to 30 ppm black or color
- Up to 1200 x 1200 dpi
- 100 and 500 sheet trays
- 50 sheet RADP
- 11" x 17" platen/paper size
- 100,000 page duty cycle
- Auto duplex copy/print/scan

- 7" color touch screen
- Mobile print enabled
- 3 USB, Gig Ethernet, 2 EIO
- 1.5 GB (Windows / Mac)
- 1 year limited warranty
- 23.2" x 23.2" x 29.6" / 174.2 lbs
- Uses: TK8117x series toners

KYOCERA ACCESSORIES

Item Code	Item Description	Fits Model	Yield	List
KY01T02P10US0	TK-6117 standard black toner	4125, 4132	15,000	\$89.00
KY01T02P17US0	MK-6117 maintenance kit (drum, dev, fuser, transfer, feed units)	4125, 4132	300,000	\$386.00
KY01702P10UN0	MK-6110 document processor maintenance kit	4125, 4132, 8124, 8130	300,000	\$38.00
COY1203NP2US0	PF-470 500 sheet paper drawer	4125, 4132, 8124, 8130		\$579.00
COY1203NN2US0	PF-471 Dual 500 sheet paper drawers	4125, 4132, 8124, 8130		\$862.00
COY1205JSOUN0	DF-470 external finisher	4132, 8130		\$829.00
COY1703NSOUN0	AK-470 attachment kit for DF-470	4132, 8130		\$85.00
COY1903JY0000	SH-10 staples (3pk - 5,000 staple each)	4125, 4132, 8124, 8130		\$57.00
COY1503S5OUN0	IB-36 wireless interface card	4125, 4132, 8124, 8130		\$142.00
COY1505J5OUN0	IB-51 wireless interface card	4125, 4132, 8124, 8130		\$554.00
KY0302K093110	WT-895 Waste toner container	4125, 4132, 8124, 8130		\$24.00
COY1503S42US0	Fax system 13	4125, 4132, 8124, 8130		\$599.00
COY855D200598	13" copier stand	4125, 4132, 8124, 8130		\$229.00
KY01T02R90US1	TK-5222K standard black toner	5521	1,200	\$67.00
KY01T02R9CUS1	TK-5222C standard cyan toner	5521	1,200	\$85.00
KY01T02R9BUS1	TK-5222M standard magenta toner	5521	1,200	\$85.00
KY01T02R9AUS1	TK-5222Y standard yellow toner	5521	1,200	\$85.00
KY01T02R70US0	TK-5242K standard black toner	5226	4,000	\$86.00
KY01T02R7CUS0	TK-5242C standard cyan toner	5226	3,000	\$109.00
KY01T02R7BUS0	TK-5242M standard magenta toner	5226	3,000	\$109.00
KY01T02R7AUS0	TK-5242Y standard yellow toner	5226	3,000	\$109.00
KY01203R60UN0	PF-5110 250 sheet paper drawer-Legal	5521, 5226		\$130.00
KY01T02TV0US0	TK-5272K standard black toner	6630	8,000	\$110.00
KY01T02TVCUS0	TK-5272C standard cyan toner	6630	6,000	\$117.00
KY01T02TVBUS0	TK-5272M standard magenta toner	6630	6,000	\$117.00
KY01T02TVAUS0	TK-5272Y standard yellow toner	6630	6,000	\$117.00
KY01702NR7US0	MK-5142 maintenance kit	6630	200,000	\$682.00
KY01T02TW0US0	TK-5282K standard black toner	6235, 6635	13,000	\$128.00
KY01T02TWCUS0	TK-5282C standard cyan toner	6235, 6635	11,000	\$186.00
KY01T02TWBUS0	TK-5282M standard magenta toner	6235, 6635	11,000	\$186.00
KY01T02TWAUS0	TK-5282Y standard yellow toner	6235, 6635	11,000	\$186.00
KY01702NS7US1	MK-5157 maintenance kit (drum, dev, fuser, transfer, feed units)	6235, 6635	200,000	\$999.00
KY01203PK0KLO	PF-5100 500 sheet paper drawer-Legal	6235, 6630, 6635		\$399.00
COY855D200713	24" copier stand	6235, 6630, 6635		\$229.00
COY1503S5OUN0	IB-36 wireless interface card	6235, 6630, 6635		\$142.00
COY1505J5OUN0	IB-51 wireless interface card	6235, 6630, 6635		\$554.00
KY01T02P30US0	TK-8117K standard black toner	8124, 8130	12,000	\$71.00
KY01T02P3CUS0	TK-8117C standard cyan toner	8124, 8130	6,000	\$98.00
KY01T02P3BUS0	TK-8117M standard magenta toner	8124, 8130	6,000	\$98.00
KY01T02P3AUS0	TK-8117Y standard yellow toner	8124, 8130	6,000	\$98.00
KY01702P30UN0	MK-8115A maintenance kit (drum, dev, fuser, transfer, feed units)	8124, 8130	200,000	\$827.90
KY01702P30UN1	MK-8115B maintenance kit (3 drums & C/M/Y developer units)	8124, 8130	200,000	\$749.00

See Page 40 for Compatible Stands

P2040dw Laser Printer w/Wireless Network and Duplex

ITEM NO.
KYO1102RY2US0

\$654⁰⁰



- Up to 42 ppm
- Up to 1200 dpi
- 100 and 250 sheet trays
- 8.5" x 14" max paper size
- 80,000 page duty cycle
- Automatic duplex printing

- PRESCRIBE, PLC6
- 2 USB, Gigabit Ethernet, WiFi
- 256 MB (Windows / Mac)
- 1 year limited warranty
- 14.8" x 15.5" x 10.7" / 31 lbs
- Uses: KYOTK1162 toner

KYO1102RW2US0 (P2235dw) **\$506.00**

P3145dn Laser Printer w/Network and Duplex

ITEM NO.
KYO1102TT2US0

\$1,459⁰⁰



- Up to 47 ppm
- Up to 1200 dpi
- 100 and 500 sheet trays
- 8.5" x 14" max paper size
- 150,000 page duty cycle
- Automatic duplex printing
- PRESCRIBE, PLC6

- Mobile device enabled
- 3 USB, Gigabit Ethernet
- 512 MB (Windows / Mac)
- 1 year limited warranty
- 15" x 16.2" x 12.1" / 32 lbs
- Uses: KYOTK3162 toner

KYO1102TS2US0 (P3150dn) **\$1,653.00**

P3155dn Laser Printer w/Network and Duplex

ITEM NO.
KYO1102TR2US0

\$1,799⁰⁰



- Up to 57 ppm
- Up to 1200 dpi
- 100 and 500 sheet trays
- 8.5" x 14" max paper size
- 250,000 page duty cycle
- Automatic duplex printing
- PRESCRIBE, PLC6

- Mobile device enabled
- 3 USB, Gigabit Ethernet
- 512 MB (Windows / Mac)
- 1 year limited warranty
- 15" x 16.2" x 13.5" / 34 lbs
- Uses: KYOTK3182 toner

KYO1102WD2US0 (P3260dn) **\$2,479.00**

P4060dn Laser Printer w/Network and Duplex

ITEM NO.
KYO1102RS2US0

\$6,178⁰⁰



- Up to 60 ppm
- HyPAS app capable
- Up to 4800 x 1200 dpi
- 9" color touch panel
- 150 and (2) 500-sheet trays
- 11" x 17" max paper size
- Automatic duplex printing
- PCL6, PRESCRIBE, KPDL3

- Mobile print supported
- 5 USB, Ethernet, NFC
- 4GB, 8GB SSD & 320GB HDD
- 1 year limited warranty
- 31" x 26" x 23.7" / 170 lbs
- Uses: KYOTK6332 toner

P5021cdw Color Laser Printer w/Wireless Network and Duplex

ITEM NO.
KYO1102RD2US0

\$598⁰⁰



- Up to 22 ppm black / color
- Up to 9,600 x 600 dpi
- 50 and 250 sheet trays
- 8.5" x 14" max paper size
- 65,000 page duty cycle
- Automatic duplex printing
- PCL6, Postscript3, PDF, XPS
- KYOCERA Mobile, AirPrint,

- Google Cloud, WiFi direct
- 2 USB, Gig Ethernet, WiFi
- 512 MB (Windows / Mac)
- 1 year parts only warranty
- 16" x 16" x 12.9" / 46 lbs
- Uses: TK5222 series toners

KYO1102RB2US0 (P5026cdw) **\$959.00**

P6235cdn Color Laser Printer w/Network and Duplex

ITEM NO.
KYO1102TW2US1

\$1,983⁰⁰



- Up to 37 ppm black / color
- Up to 9600 x 600
- 100 and 500 sheet trays
- 8.5" x 14" max paper size
- 100,000 page duty cycle
- Automatic duplex printing
- PRESCRIBE, PLC6

- Mobile device enabled
- 3 USB, Gigabit Ethernet
- 1 GB (Windows / Mac)
- 1 year parts only warranty
- 15.4" x 21" x 18.5" / 84 lbs
- Uses: TK5282 series toners

KYO1102TV2US1 (P6230Cdn) **\$999.00**

P7240cdn Color Laser Printer w/Network and Duplex

ITEM NO.
KYO1102TX2US0

\$1,999⁰⁰



- Up to 42 ppm black / color
- Up to 9600 x 600
- 100 and 500 sheet trays
- 8.5" x 14" max paper size
- 150,000 page duty cycle
- Automatic duplex printing
- PRESCRIBE, PLC6

- Mobile device enabled
- 3 USB, Gigabit Ethernet
- 1 GB (Windows / Mac)
- 1 year parts only warranty
- 15.4" x 21" x 18.5" / 88.2 lbs
- Uses: TK5292 series toners

P8060cdn Color Laser Printer w/Network and Duplex

ITEM NO.
KYO1102RR2US0

\$3,999⁰⁰



*Shown w/ Options



- Up to 60 ppm black, 55 color
- Up to 9600 x 600
- 150 and (2) 500 sheet trays
- 12" x 18" tray; 48" paper
- 250,000 page duty cycle
- Automatic duplex printing
- 9" color touch screen

- AirPrint, KYOCERA, Cloud apps
- NFC & WiFi direct support
- 5 USB, Gig Ethernet, 2 EIO
- 4GB, 8GB SSD & 320GB HDD
- 3 year parts only warranty
- 23.7" x 26.2" x 31.1" / 196 lbs
- Uses: TK8602 series toners

KYOCERA ACCESSORIES

Item Code	Item Description	Fits Model	Yield	List
KY01T02RY0USO	TK-1162 standard black toner	2040		\$91.00
KY01T02RV0USO	TK-1152 standard black toner	2235		\$68.33
KY01T02RV0USO	MK-1152 maintenance kit (drum & dev units)	2040, 2235		\$182.00
COY1203RA0UNO	PF-1100 250 sheet paper drawer-Legal	2040, 2235		\$130.00
COY855D200756	13" copier stand	2040, 2235		\$285.00
KY01T02T90USO	TK-3162 standard black toner	3145	12,500	\$105.00
KY01T02T80USO	TK-3172 standard black toner	3150	15,500	\$92.00
KY01T02T70USO	TK-3182 standard black toner	3155	21,000	\$97.00
KY01T02T60USO	TK-3192 standard black toner	3260	25,000	\$105.00
KY01203SA0KLO	PF-3110 500 sheet paper drawer-Legal	3145, 3150, 3155, 3260		\$249.00
KY01203S30KLO	PF-3100 2,000 sheet paper drawer-Legal	3145, 3150, 3155, 3260		\$867.00
KY01903N10UNO	PB-325 PF-3100 base	3145, 3150, 3155, 3260		\$219.00
COY855D200655	25" copier stand	3145, 3150, 3155, 3260		\$319.00
COY1503S50UNO	IB-36 wireless interface card	3145, 3150, 3155, 3260		\$142.00
COY1505J50UNO	IB-51 wireless interface card	3145, 3150, 3155, 3260		\$554.00
KY01T02RS0USO	TK-6332 standard black toner	4060	32,000	\$130.00
KY01T02R90US1	TK-5222K standard black toner	5021	1,200	\$67.00
KY01T02R9CUS1	TK-5222C standard cyan toner	5021	1,200	\$85.00
KY01T02R9BUS1	TK-5222M standard magenta toner	5021	1,200	\$85.00
KY01T02R9AUS1	TK-5222Y standard yellow toner	5021	1,200	\$85.00
KY01T02R70USO	TK-5242K standard black toner	5026	4,000	\$86.00
KY01T02R7CUSO	TK-5242C standard cyan toner	5026	3,000	\$109.00
KY01T02R7BUSO	TK-5242M standard magenta toner	5026	3,000	\$109.00
KY01T02R7AUSO	TK-5242Y standard yellow toner	5026	3,000	\$109.00
KY01203R60UNO	PF-5110 250 sheet paper drawer-Legal	5021, 5026		\$130.00
KY01T02TV0USO	TK-5272K standard black toner	6230	8,000	\$110.00
KY01T02TVCUSO	TK-5272C standard cyan toner	6230	6,000	\$117.00
KY01T02TVBUSO	TK-5272M standard magenta toner	6230	6,000	\$117.00
KY01T02TVAUSO	TK-5272Y standard yellow toner	6230	6,000	\$117.00
KY01T02TW0USO	TK-5282K standard black toner	6235	13,000	\$128.00
KY01T02TWCUSO	TK-5282C standard cyan toner	6235	11,000	\$186.00
KY01T02TWBUSO	TK-5282M standard magenta toner	6235	11,000	\$186.00
KY01T02TWAUSO	TK-5282Y standard yellow toner	6235	11,000	\$186.00
KY01T02TX0USO	TK-5292K standard black toner	7240	17,000	\$150.00
KY01T02TXCUSO	TK-5292C standard cyan toner	7240	13,000	\$200.00
KY01T02TXBUSO	TK-5292M standard magenta toner	7240	13,000	\$200.00
KY01T02TXAUSO	TK-5292Y standard yellow toner	7240	13,000	\$200.00
KY01203PK0KLO	PF-5100 500 sheet paper drawer-Legal	6230, 6235, 7240		\$399.00
KY01T02MN0USO	TK-8602 standard black toner	8060	30,000	\$160.00
KY01T02MNCUSO	TK-8602 standard cyan toner	8060	20,000	\$281.00
KY01T02MNBUSO	TK-8602 standard magenta toner	8060	20,000	\$281.00
KY01T02MNAUSO	TK-8602 standard yellow toner	8060	20,000	\$281.00
COY1902ND0UNO	WT-8500 Waste toner container	8060		\$25.00
COY1203RB2USO	PF-7100 Dual 500 sheet paper drawers-Ledger	4060, 8060		\$1,287.00
COY1203RC2USO	PF-7110 Dual 1,500 sheet paper drawers-Letter	4060, 8060		\$1,380.00
COY1203RL2USO	PF-7120 3,000 sheet side paper drawer-Letter	4060, 8060		\$1,417.00
COY855D200713	24" copier stand	4060, 6230, 6235, 7240, 8060		\$229.00
COY1503S50UNO	IB-36 wireless interface card	6230, 6235, 7240		\$142.00
COY1505J50UNO	IB-51 wireless interface card	4060, 6230, 6235, 7240, 8060		\$554.00

LX-350 *Dot Matrix Impact Printer*

ITEM NO.
EPSC11CC24001

- 9 pin / narrow carriage
- 10" max paper width
- Up to 390 cps (15 cpi)
- Accepts 5 part forms
- Resident and bar code fonts

- 10,000 hours reliability
- Ribbon life: 4 million
- Printhead: 400 million
- USB, Parallel, Serial
- 128 KB (Windows)

\$245⁰⁰

- 2 year limited warranty
- 14" x 11" x 6" / 9 lbs
- Uses: S015631 ribbon



FX-890II *Dot Matrix Impact Printer*

ITEM NO.
EPSC11CF37201

\$379⁰⁰

- 9 pin / narrow carriage
- 10" max paper width
- Up to 738 cps (12 cpi)
- Accepts 7 part forms
- Resident and bar fonts
- 25,000 hours reliability
- Ribbon life: 7.5 million

- Printhead: 400 million
- 128 KB, USB, Parallel
- Windows compatible
- 3 year limited warranty
- 17.2" x 14.8" x 7" / 16 lbs
- Uses: S015329 ribbon



FX-2190II *Dot Matrix Impact Printer*

ITEM NO.
EPSC11CF38201

\$549⁰⁰

- 9 pin / wide carriage
- 16.5" max paper width
- Up to 738 cps (12 cpi)
- Accepts 7 part forms
- Resident and bar fonts
- 25,000 hours reliability
- Ribbon life: 12 million

- Printhead: 400 million
- 128 KB, USB, Parallel
- Windows compatible
- 3 year limited warranty
- 24" x 14.8" x 7" / 21 lbs
- Uses: S015335 ribbon



LQ-590II *Dot Matrix Impact Printer*

ITEM NO.
EPSC11CF39201

\$399⁰⁰

- 24 pin / narrow carriage
- 10" max paper width
- Up to 584 cps (12 cpi)
- Accepts 5 part forms
- Resident and bar code fonts
- 25,000 hours reliability
- Ribbon life: 5 million

- Printhead: 400 million
- 128 KB, USB, Parallel
- Windows compatible
- 3 year limited warranty
- 16" x 14" x 6" / 16 lbs
- Uses: S015337 ribbon



LQ-2090II *Dot Matrix Impact Printer*

ITEM NO.
EPSC11CF40201

\$578⁰⁰

- 24 pin / wide carriage
- 16.5" max paper width
- Up to 584 cps (12 cpi)
- Accepts 5 part forms
- Resident and bar code fonts
- 25,000 hours reliability
- Ribbon life: 8 million

- Printhead: 400 million
- 128 KB, USB, Parallel
- Windows compatible
- 3 year limited warranty
- 24.1" x 12.6" x 7" / 21 lbs
- Uses: S015335 ribbon



WF-C5290 *Workforce Pro Color Inkjet Printer w/Wireless Network and Duplex*

ITEM NO.
EPSC11CG05201

\$320⁰⁰

- Up to 24 iso black or color
- Up to 4800 x 1200 dpi
- 80 & 250 sht trays, 50 pg ADF
- 8.5" x 47" max paper size
- 45,000 page duty cycle
- Automatic duplex printing
- 2.4" color touchscreen

- ESC/P-R, PCL5/6, PostScript3
- AirPrint, iPrint, Cloud apps
- USB, Ethernet, WiFi Direct
- 2 year limited warranty
- 23" x 17.7" x 16.7" / 34 lbs
- Uses: T902 series inks



WF-C8190 *Workforce Pro Color Inkjet Printer w/Wireless Network and Duplex*

ITEM NO.
EPSC11CG70201

\$1,679⁰⁰

- Up to 24 iso black or color
- Up to 4800 x 1200 dpi
- 80 and 250 sheet trays
- 13" x 19" max paper size
- 75,000 page duty cycle
- Automatic duplex printing
- 2.4" color touchscreen

- ESC/P-R, PCL5/6, PostScript3
- AirPrint, iPrint, Cloud apps
- USB, Ethernet, WiFi Direct
- 2 year limited warranty
- 34" x 24" x 22.5" / 78 lbs
- Uses: T912 series inks



Call Your Sales Representative Today

WF-C5710 *Workforce Pro Color Inkjet Fax, Copier, Printer, Scanner w/Wireless Network and Duplex*

ITEM NO.
EPSC11CG03201

\$329⁰⁰



- 33.6 Kbps / 200 dials
- Up to 24 iso black or color
- Up to 4800 x 1200 dpi
- 250 sheet tray, 50 page ADF
- 8.5" x 14" platen; 47" paper
- 45,000 page duty cycle
- Full auto duplex fx/co/pt/sc

- 4.3" color touchscreen
- AirPrint, iPrint, Cloud apps
- USB, Ethernet, WiFi
- 2 year limited warranty
- 23" x 17.7" x 16.7" / 41 lbs
- Uses: T902 series inks

WF-EC4040 *Workforce Pro Color Inkjet Fax, Copier, Printer, Scanner w/Wireless Network and Duplex*

ITEM NO.
EPSC11CF75203

\$299⁰⁰



- 33.6 Kbps / 100 dials
- Up to 24 iso black, 22 color
- Up to 4800 x 1200 dpi
- (2) 250 sht trays, 50 page ADF
- 8.5" x 14" platen; 47" paper
- 30,000 page duty cycle
- Full auto duplex fx/co/pt/sc

- 4.3" color touchscreen
- AirPrint, iPrint, Cloud apps
- USB, Ethernet, WiFi, NFC
- 2 year limited warranty
- 20" x 16.7" x 13" / 26 lbs
- Uses: T802 series inks

WF-ST2000 *Workforce Color EcoTank Copier, Printer, Scanner w/Wireless Network and Duplex*

ITEM NO.
EPSC11CG22202

\$345⁰⁰



- Up to 10.5 iso black, 5 color
- Up to 5760 x 1440 dpi
- 100 sheet paper tray
- 8.5" x 11" platen, 47" paper
- Automatic duplex printing
- AirPrint, iPrint, Cloud apps

- USB, WiFi, WiFi Direct, SD
- 2 year limited warranty
- 22" x 14.8" x 10.5" / 12 lbs
- Uses: T502 series inks

WF-C5790 *Workforce Pro Color Inkjet Fax, Copier, Printer, Scanner w/Wireless Network and Duplex*

ITEM NO.
EPSC11CG02201

\$385⁰⁰



- 33.6 Kbps / 200 dials
- Up to 24 iso black or color
- Up to 4800 x 1200 dpi
- 250 sheet tray, 50 page ADF
- 8.5" x 14" platen; 47" paper
- 45,000 page duty cycle
- Full auto duplex fx/co/pt/sc

- 4.3" color touchscreen
- ESC/P-R, PCL5/6, PostScript3
- AirPrint, iPrint, Cloud apps
- USB, Ethernet, WiFi Direct
- 2 year limited warranty
- 23" x 17.7" x 16.7" / 41 lbs
- Uses: T902 series inks

WF-ST3000 *Workforce Color EcoTank Copier, Printer, Scanner w/Wireless Network and Duplex*

ITEM NO.
EPSC11CG20202

\$445⁰⁰



- Up to 15 iso black, 8 color
- Up to 4800 x 1200 dpi
- 150 sheet paper tray
- 30 page ADF
- 8.5" x 14" platen, 47" paper
- Automatic duplex printing

- 2.4" color touchscreen
- AirPrint, iPrint, Cloud apps
- USB, Ethernet, WiFi Direct
- 2 year limited warranty
- 19.8" x 16.4" x 10" / 15 lbs
- Uses: T502 series inks

WF-ST4000 *Workforce Color EcoTank Fax, Copier, Printer, Scanner w/Wireless Network and Duplex*

ITEM NO.
EPSC11CG19202

\$519⁰⁰



- 33.6 Kbps / 60 speed dials
- Up to 15 iso black, 8 color
- Up to 4800 x 1200 dpi
- 150 sheet tray, 30 page ADF
- 11.7" x 11.7" scan platen
- 13" x 47" max paper size
- Automatic duplex printing

- 2.4" color touchscreen
- AirPrint, iPrint, Cloud apps
- USB, Ethernet, WiFi Direct
- 2 year limited warranty
- 19.8" x 16.4" x 10" / 16 lbs
- Uses: T502 series inks

WF-M5799 *Workforce Pro Inkjet Fax, Copier, Printer, Scanner w/Wireless Network and Duplex*

ITEM NO.
EPSC11CG04201

\$359⁰⁰



- 33.6 Kbps / 200 dials
- Up to 24 iso ppm / 22 cpm
- Up to 4800 x 1200 dpi
- 80 & 250 sht trays, 50 pg ADF
- 8.5" x 14" platen; 47" paper
- 45,000 page duty cycle
- Full auto duplex fx/co/pt/sc

- 4.3" color touchscreen
- ESC/P-R, PCL5/6, PostScript3
- AirPrint, iPrint, Cloud apps
- USB, Ethernet, WiFi Direct
- 2 year limited warranty
- 23" x 17.7" x 16.7" / 41 lbs
- Uses: M02 black inks

WF-C8690 *Workforce Pro Color Inkjet Fax, Copier, Printer, Scanner w/Wireless Network and Duplex*

ITEM NO.
EPSC11CG68201

\$1,722⁰⁰



- 33.6 Kbps / 200 dials
- Up to 24 iso black or color
- Up to 4800 x 1200 dpi
- 85, 250 and 500 sheet trays
- 50 page ADF
- 11" x 17" platen
- 13" x 47" max paper size
- 75,000 page duty cycle

- Full auto duplex fx/co/pt/sc
- 5" color touchscreen
- ESC/P-R, PCL5/6, PostScript3
- AirPrint, iPrint, Cloud apps
- USB, Ethernet, WiFi Direct
- 2 year limited warranty
- 34" x 24" x 22.5" / 101 lbs
- Uses: T912 series inks

IX100 ScanSnap Mobile Scanner

ITEM NO.
FJIX100



\$270⁰⁰

- Compact and Portable
- Dual Scan
- Up to 600 dpi
- 8.5" x 34" paper size
- Quick digitization
- Continuous Document Feeding
- Auto two page stitching
- Scans credit cards
- USB, WiFi (Windows / Mac)
- Battery powered
- 1 year limited warranty
- 10.7" x 1.9" x 1.4" / 0.9 lb

S1300I ScanSnap Mobile Scanner

ITEM NO.
FJIS1300I



\$349⁰⁰

- Up to 12 ppm
- 8.5" x 14" paper size
- 10 sheet ADF
- Duplex scanning
- Scans documents, receipts, cards
- Auto paper size detection
- Auto deskew & orientation
- USB powered
- Windows / Mac
- 1 year limited warranty
- 11.2" x 3.9" x 3" / 3.1 lbs

IX1500 Scan Snap Sheetfed Scanner

ITEM NO.
FJIX1500



\$585⁰⁰

- Up to 30 ppm
- 8.5" x 118" paper size
- 50 sheet ADF
- Up to 600 dpi
- Duplex scanning
- Scans cards, receipts
- Length & overlap detection
- Streak reduction
- 4.3" color touch screen
- USB, WiFi (Windows / Mac)
- 1 year limited warranty
- 11.5" x 6.3" x 6" / 7.5 lbs

FI7030 Desktop Document Scanner

ITEM NO.
FJIFI7030



\$675⁰⁰

- Up to 27 ppm
- 54 ppm in duplex mode
- Up to 600 dpi
- 8.5" x 220" paper size
- 50 sheet ADF
- Duplex scanning
- Scans embossed cards
- PaperStream Capture
- Scanner Central Admin
- USB (Windows / Mac)
- 1 year limited warranty
- 11.4" x 5.74" x 5.1" / 6.4 lbs

FI7140 Workgroup Document Scanner

ITEM NO.
FJIFI7140



\$905⁰⁰

- Up to 40 ppm
- 80 ppm in duplex mode
- Up to 600 dpi
- 8.5" x 220" paper size
- 80 sheet ADF
- Duplex scanning
- Auto image correction
- Auto deskew
- Vertical streak reduction
- USB (Windows / Mac)
- 1 year limited warranty
- 11.8" x 6.7" x 6.4" / 9.3 lbs

FI7160 Workgroup Document Scanner

ITEM NO.
FJIFI7160



\$1,250⁰⁰

- Up to 60 ppm
- 120 ppm in duplex mode
- Up to 600 dpi
- 8.5" x 220" paper size
- 80 sheet ADF
- Scans embossed cards
- Auto deskew
- Auto image correction
- Streak reduction
- USB (Windows / Mac)
- 1 year limited warranty
- 11.8" x 6.7" x 6.4" / 9.3 lbs

FJIFI7240 **\$1,719.00**

FJIFI7260 **\$1,799.00**

N7100 Network Document Scanner

ITEM NO.
FJIN7100



\$1,989⁰⁰

- Up to 25 ppm
- 50 ppm in duplex mode
- Up to 600 dpi
- 11" x 120" paper size
- 50 sheet ADF
- Auto deskew
- Auto orientation
- Image cleanup
- 8.3" color touch screen
- Ethernet (Windows)
- 1 year limited warranty
- 11.8" x 9.1" x 6.8" / 13.2 lbs

FI7180 Departmental Document Scanner

ITEM NO.
FJIFI7180



\$2,099⁰⁰

- Up to 80 ppm
- 160 ppm in duplex mode
- Up to 600 dpi
- 8.5" x 220" paper size
- 80 sheet ADF
- Auto deskew
- Auto orientation
- Image cleanup
- USB (Windows / Mac)
- 1 year limited warranty
- 11.8" x 6.7" x 6.4" / 9.3 lbs

FJIFI7280 **\$2,618.00**

OJP8035 Color Inkjet Fax, Copier, Printer, Scanner w/Wireless Network and Duplex

ITEM NO.
HEW5LJ23A

\$219⁰⁰



- 99 speed dials/20 broadcast
- Up to 29 ppm black, 25 color
- Up to 4800 x 1200 dpi
- 225 sheet tray, 35 page ADF
- 8.5" x 11" platen; 14" paper
- 20,000 page duty cycle
- Automatic duplex printing
- 2.7" color touch screen

- AirPrint, ePrint, Mopria apps
- Google Cloud & Web access
- 2 USB, Ethernet, WiFi, RJ-11
- 256 MB (Windows / Mac)
- 1 year limited warranty
- 18.1" x 13.5" x 9.2" / 18 lbs
- HP #910 or #910XL series inks

OJP8025 Color Inkjet Fax, Copier, Printer, Scanner w/Wireless Network and Duplex

ITEM NO.
HEW1KR57A

\$255⁰⁰



- 99 speed dials/20 broadcast
- Up to 20 ppm black, 10 color
- Up to 4800 x 1200 dpi
- 225 sheet tray, 35 page ADF
- 8.5" x 11" platen; 14" paper
- 20,000 page duty cycle
- Automatic duplex printing
- 2.7" color touch screen

- AirPrint, ePrint, Mopria apps
- Google Cloud & Web access
- USB, Ethernet, WiFi, RJ-11
- 256 MB (Windows / Mac)
- 1 year limited warranty
- 18.1" x 13.4" x 9.2" / 18 lbs
- HP #910 or #910XL series inks

OJ3830 Color Inkjet Fax, Copier, Printer, Scanner w/Wireless Network

ITEM NO.
HEWK7V40A

\$339⁰⁰



- 33.6 Kbps / 99 page memory
- Up to 20 ppm black, 16 color
- Up to 4800 x 1200 dpi
- 60 sheet tray; 35 page ADF
- 8.5" x 11" platen; 14" paper
- 2.2" touch magic frame display

- AirPrint, Mobile phone apps
- USB, WiFi, RJ-11
- 512 MB (Windows only)
- 1 year limited warranty
- 17.7" x 14.3" x 8.5" / 12 lbs
- HP #63 or #63XL series inks

OJP9015 Color Inkjet Fax, Copier, Printer, Scanner w/Wireless Network and Duplex

ITEM NO.
HEW1KR42A

\$480⁰⁰



- 99 speed dials/20 broadcast
- Up to 22 ppm black, 18 color
- Up to 1200 x 1200 dpi
- 250 sheet tray, 35 page ADF
- 8.5" x 11" platen; 14" paper
- 25,000 page duty cycle
- Automatic duplex printing
- 2.65" color touch screen

- AirPrint, ePrint, Mopria apps
- Google Cloud & Web access
- 2 USB, Ethernet, WiFi, RJ-11
- 512 MB (Windows / Mac)
- 1 year limited warranty
- 17.3" x 13.5" x 11" / 19.7 lbs
- HP #962 or #962XL series inks

OJP9025 Color Inkjet Fax, Copier, Printer, Scanner w/Wireless Network and Duplex

ITEM NO.
HEW1MR66A

\$551⁰⁰



- 99 speed dials/20 broadcast
- Up to 24 ppm black, 20 color
- Up to 1200 x 1200 dpi
- 250 sheet tray, 35 page ADF
- 8.5" x 11" platen; 14" paper
- 30,000 page duty cycle
- Automatic duplex printing
- 2.65" color touch screen

- AirPrint, ePrint, Mopria apps
- Google Cloud & Web access
- 2 USB, Ethernet, WiFi, RJ-11
- 512 MB (Windows / Mac)
- 1 year limited warranty
- 17.2" x 15.6" x 12.5" / 26.5 lbs
- HP #962 or #962XL series inks

OJP7740 Color Inkjet Fax, Copier, Printer, Scanner w/Wireless Network and Duplex

ITEM NO.
HEWG5J38A

\$585⁰⁰



- 100 page memory / 99 dials
- Up to 22 ppm black, 18 color
- Up to 4800 x 1200 dpi
- (2)250 sht trays, 35 page ADF
- 11" x 17" platen/paper size
- 18,000 page duty cycle
- Automatic duplex printing

- 2.65" touchscreen panel
- Native PDF, PCL6, PostScript3
- AirPrint, ePrint, Cloud apps
- USB, Ethernet, WiFi, (2)RJ-11
- 1 year limited warranty
- 23" x 18.4" x 15" / 42.9 lbs
- HP #952 or #952XL series inks

OJ250 Color Mobile Printer, Copier, Scanner

ITEM NO.
HEWCZ992A

\$595⁰⁰



- Up to 20 ppm black, 18 color
- Up to 4800 x 1200 dpi
- 50 sheet tray; 10 page ADF
- 8.5" x 14" max paper size
- 500 page duty cycle

- 2.65" color touch display
- 90 min AC battery recharge
- Mopria, ePrint compatible
- 2 USB, Bluetooth, WiFi direct
- 256 MB (Windows / Mac)

- 1 year limited warranty
- 15" x 7.8" x 3.6" / 6.5 lbs
- HP #62 or #62XL series inks

LJM130FN Laser Fax, Copier, Printer, Color Scanner w/Network

ITEM NO.
HEWG3Q59A

\$415⁰⁰

- 33.6 Kbps / 120 speed dials
- Up to 23 cpm / ppm
- Up to 600 x 600 dpi
- 150 sheet tray, 35 page ADF
- 8.5" x 11" platen; 14" paper
- 10,000 page duty cycle
- 2-line LCD display



- Mobile ePrint, AirPrint able
- USB, Ethernet, RJ-11
- 256 MB (Windows / Mac)
- 1 year limited warranty
- 16.4" x 11.4" x 11" / 17 lbs
- CF217A toner, CF219A drum

HEWG3Q60A (LJM130FW).....**\$665.00**

LJM148FDW Laser Fax, Copier, Printer, Scanner w/Wireless Network and Duplex

ITEM NO.
HEW4PA42A

\$419⁰⁰

- Fax 3 spp / 120 speed dials
- Up to 30 cpm / ppm
- Up to 1200 x 1200 dpi
- 10 and 250 sheet trays
- 35 sheet ADF
- 8.5" x 11.7" platen; 14" paper
- 20,000 page duty cycle



- Automatic duplex printing
- AirPrint, ePrint, Cloud apps
- USB, Ethernet, WiFi, RJ-11
- 256 MB (Windows / Mac)
- 1 year limited warranty
- 16" x 15.9" x 12" / 21 lbs
- CF294A toner, CF232A drum

LJM182NW Color Laser Copier, Printer, Scanner w/Wireless Network

ITEM NO.
HEW7KW55A

\$665⁰⁰

- Up to 17 ppm black or color
- Up to 600 x 600 dpi
- 150 sheet input tray
- 8.5" x 14" max paper size
- 30,000 page duty cycle
- 2-line LCD with keypad



- AirPrint, ePrint, Mopria
- USB, Ethernet, WiFi direct
- 256 MB (Windows / Mac)
- 1 year limited warranty
- 17" x 16.5" x 11.6" / 34.6 lbs
- Uses: HP 215A series toners

LJM283FDW Color Laser Fax, Copier, Printer, Scanner w/Wireless Network and Duplex

ITEM NO.
HEW7KW75A

\$835⁰⁰

- 33.6 kbps / 120 speed dials
- Up to 22 ppm black or color
- Up to 600 x 600 dpi
- 250 sheet input tray
- 50 sheet ADF
- 8.5" x 11" platen; 14" paper
- 40,000 page duty cycle
- Automatic duplex pt,co,sc



- 2.7" color touch screen
- AirPrint, ePrint, Mopria
- USB, Ethernet, WiFi, RJ-45
- 512 MB (Windows / Mac)
- 1 year limited warranty
- 16.6" x 16.5" x 13" / 41 lbs
- Uses: HP 206A series toners

LJM428FDW Laser Fax, Copy, Print, Scanner w/Wireless Network and Duplex

ITEM NO.
HEWW1A30A

\$725⁰⁰

- 33.6 Kbps / 120 speed dials
- Up to 40 cpm / ppm
- Up to 1200 x 1200 dpi
- 100 and 250 sheet trays
- 50 sheet ADF
- 8.5" x 11" platen; 14" paper
- 80,000 page duty cycle
- Automatic duplex printing



- 2.7" color touch screen
- Mopria, ePrint, AirPrint able
- 2 USB, Ethernet, WiFi
- 512 MB (Windows / Mac)
- 1 year limited warranty
- 16.5" x 15.4" x 12.7" / 28 lbs
- Uses: CF258A or CF258X toners

HEWW1A29A (LJM428FDN).....**\$725.00**

LJM479FDN Color Laser Fax, Copier, Printer, Scanner w/Network and Duplex

ITEM NO.
HEWW1A79A

\$935⁰⁰

- 33.6 Kbps / 120 speed dials
- Up to 28 ppm black or color
- Up to 600 x 600 dpi
- 50 and 250 sheet trays
- 50 sheet ADF
- 8.5" x 11" platen; 14" paper
- 50,000 page duty cycle
- Auto duplex print/ADF scan



- 4.3" color touch screen
- Mobile ePrint, AirPrint able
- 2 USB, Gigabit Ethernet
- 512 MB (Windows / Mac)
- 1 year limited warranty
- 16.8" x 16.3" x 25.7" / 52 lbs
- Uses: HP 414A series toners

HEWW1A80A (LJM479FDW).....**\$935.00**

LJM521DN Laser Fax, Copier, Printer, Scanner w/Network and Duplex

ITEM NO.
HEWA8P79A

\$1,812⁰⁰

- 33.6 Kbps / 100 speed dials
- Up to 42 cpm / ppm
- Up to 1200 x 1200 dpi
- 100 and 500 sheet trays
- 50 sheet ADF
- 8.5" x 11" platen; 14" paper
- 75,000 page duty cycle
- Auto duplex print/ADF scan



- 3.5" touch screen display
- Mopria, ePrint, AirPrint able
- 2 USB, Gigabit Ethernet
- 256 MB (Windows / Mac)
- 1 year limited warranty
- 18.3" x 18.3" x 20" / 53 lbs
- Uses: CE255A or CE255X toners

LJM528DN Laser Copier, Printer, Scanner w/Network and Duplex

ITEM NO.
HEW1PV64A

\$3,325⁰⁰

- Up to 45 cpm / ppm
- Up to 1200 x 1200 dpi
- 100 and 550 sheet trays
- 100 sheet ADF
- 8.5" x 14" platen/paper size
- 150,000 page duty cycle
- Auto duplex print/ADF scan
- PCL5c/6, PostScript 3, PDF



- 8" touch screen display
- Mopria, ePrint, AirPrint able
- 2 USB, Gigabit Ethernet
- 1.25 GB (Windows / Mac)
- 1 year limited warranty
- 19" x 19.5" x 19.6" / 48 lbs
- Uses: CE289A or CE289X toners

LJM118DW Laser Printer w/Wireless Network and Duplex

ITEM NO.
HEW4PA39A

\$276⁰⁰



- Up to 30 ppm
- Up to 1200 x 1200 dpi
- 250 sheet input tray
- 10 sheet priority slot
- 8.5" x 14" max paper size
- 20,000 page duty cycle
- Automatic duplex printing

- AirPrint, ePrint, Cloud apps
- USB, Ethernet, WiFi direct
- 256 MB (Windows / Mac)
- 1 year limited warranty
- 16" x 14.6" x 8.8" / 15 lbs
- CF294A toner, CF232A drum

LJM454DN Color Laser Printer w/Network and Duplex

ITEM NO.
HEWW1Y44A

\$849⁰⁰



- Up to 28 ppm black / color
- Up to 600 x 600 dpi
- 50 and 250 sheet trays
- 8.5" x 14" max paper size
- 50,000 page duty cycle
- Automatic duplex printing
- PCL5c/6, PostScript 3, PDF

- Mobile print app certified
- 2 USB, Gigabit Ethernet
- 256 MB (Windows / Mac)
- 1 year limited warranty
- 16.2" x 18.5" x 11.6" / 41.7 lbs
- HP 414A or 414X series toners

HEWW1A54A (LJM454DN) **\$920.00**

LJM553N Color Laser Printer w/Network

ITEM NO.
HEWB5L24A

\$1,693⁰⁰



- Up to 40 ppm black / color
- ImageRet 3600 dpi
- 100 and 550 sheet trays
- 8.5" x 14" max paper size
- 80,000 page duty cycle
- 4 line LCD with 10-key pad
- PCL5c, PCL6, PostScript 3

- AirPrint, ePrint, Mopria
- 3 USB, Gigabit Ethernet
- 1 GB (Windows / Mac)
- 1 year limited warranty
- 18.9" x 18" x 15.7" / 59.5 lbs
- Uses: HP 508A series toners

HEWB5L25A (LJM553DN) **\$2,521.00**

LJM751N Color Laser Printer w/Network

ITEM NO.
HEWT3U43A

- Up to 40 ppm black / color
- Up to 1200 x 1200 dpi
- 100 and 550 sheet trays
- 12" x 18" max paper size

- 150,000 page duty cycle
- PCL5, PCL6, PostScript 3
- Mobile ePrint, AirPrint able
- 3 USB, Gigabit Ethernet

HEWT3U44A (LJM751DN) **\$3,825.00**

LJM404N Laser Printer w/Network and Duplex

ITEM NO.
HEWW1A53A

\$425⁰⁰



- Up to 40 ppm
- Up to 1200 x 1200 dpi
- 100 and 250 sheet trays
- 8.5" x 14" max paper size
- 80,000 page duty cycle
- Automatic duplex printing
- PCL5e, PCL6, PostScript 3

- Mobile ePrint, AirPrint able
- 2 USB, Gigabit Ethernet
- 256 MB (Windows / Mac)
- 1 year limited warranty
- 15" x 8.5" x 14" / 19 lbs
- Uses: CF258A or CF258X toners

HEWW1A52A (LJM404DN) **\$551.00**
HEWW1A54A (LJM404DW) **\$608.00**

LJM507N Laser Printer w/Network

ITEM NO.
HEW1PV86A

\$1,061⁰⁰



- Up to 45 ppm
- Up to 1200 x 1200 dpi
- 100 and 550 sheet trays
- 8.5" x 14" max paper size
- 150,000 page duty cycle
- 2.7" LCD color display
- PCL5/6, PostScript 3, PDF

- AirPrint, ePrint, Mopria ready
- 3 USB, Gigabit Ethernet
- 512 MB (Windows / Mac)
- 1 year limited warranty
- 16.5" x 14.8" x 11.8" / 24.7 lbs
- Uses: CF289A or CF289X toners

HEWW1A54A (LJM507DN) **\$1,345.00**

LJM653DN Color Laser Printer w/Network and Duplex

ITEM NO.
HEWJ8A04A

\$2,699⁰⁰



- Up to 60 ppm black / color
- Up to 1200 x 1200 dpi
- 100 and 550 sheet trays
- 8.5" x 14" max paper size
- 120,000 page duty cycle
- Automatic duplex printing
- 4.3" color touch screen

- PCL5c, PCL6, PostScript 3
- Mobile ePrint, AirPrint able
- 3 USB, Gigabit Ethernet
- 1 GB (Windows / Mac)
- 1 year limited warranty
- 20.1" x 18" x 20.1" / 69 lbs
- Uses: HP 655A series toners



\$3,545⁰⁰

- 1.5 GB (Windows/ Mac)
- 1 year limited warranty
- 22" x 23." x 16" / 100 lbs
- Uses: HP 658A series toners

SJ2000 ScanJet Pro s2 Flatbed Scanner

ITEM NO.
HEW6FW06A

\$470⁰⁰



- Up to 35 ppm color/grayscale
- Single-pass duplex, 70 ipm
- 50 sheet ADF, 600 dpi
- 8.5" x 122" max scan size
- Up to 3,500 scans daily
- ID cards, checks, receipts
- One-button custom settings

- Auto color detect, drop out
- Auto crop, orient, exposure
- OCR, HP Scan software
- USB (Windows / Mac / Linux)
- TWAIN, WIA, ISIS drivers
- 11.8" x 6.8" x 6" / 6 lbs

SJ3000 ScanJet Pro s4 Flatbed Scanner

ITEM NO.
HEW6FW07A

\$612⁰⁰



- Up to 40 ppm color/grayscale
- Single-pass duplex, 80 ipm
- 50 sheet ADF, 600 dpi
- 8.5" x 122" max scan size
- Up to 4,000 scans daily
- ID cards, carbonless forms
- One-button custom settings

- Color, size, multi-feed detect
- Auto exposure & threshold
- OCR, HP scan software
- 256 MB, USB (Win/Mac/Linux)
- TWAIN, WIA, ISIS drivers
- 11.8" x 6.8" x 6" / 6 lbs

SJN4000 ScanJet Pro SNW1 Scanner

ITEM NO.
HEW6FW08A

\$741⁰⁰



- Up to 40 ppm color/grayscale
- Single-pass duplex, 80 ipm
- 50 sheet ADF, 600 dpi
- 12" x 220" max scan size
- Up to 4,000 pages daily
- 2.8" color touchscreen
- One-button custom settings

- Multifeed, color detection
- Scan from mobile devices
- HP EveryPage HP Scan, OCR
- USB, Ethernet, WiFi, WiFi direct
- TWAIN, WIA, ISIS drivers
- 11.8" x 6.8" x 6" / 6 lbs

SJ5000 ScanJet Enterprise Flow s5 Scanner

ITEM NO.
HEW6FW09A

\$1,140⁰⁰



- Up to 65 ppm color/grayscale
- Single-pass duplex, 130 ipm
- 80 sheet ADF, 600 dpi
- 8.5" x 122" max scan size
- Up to 7,500 scans daily
- Two line LCD display
- Auto color detect, drop out

- Auto crop, orient, exposure
- HP Scan Premium software
- OCR, Readiris Pro, Cardiris
- 512 MB, 2 USB (Win / Mac)
- TWAIN, WIA, ISIS drivers
- 12.2" x 7.8" x 7.5" / 8.4 lbs

SJN7000 Enterprise Flow SNW1 Scanner

ITEM NO.
HEW6FW10A

\$1,570⁰⁰



- Up to 75 ppm color/grayscale
- Single-pass duplex, 150 ipm
- 80 sheet ADF, 1200 dpi
- 8.5" x 220" max scan size
- Up to 7,500 pages daily
- 4.3" color touch panel
- 6 preconfigured destinations

- Back, home, help buttons
- Scan from mobile devices
- HP EveryPage, Scan Premium
- 2 USB, Ethernet, WiFi direct
- OCR, TWAIN, WIA, ISIS
- 12" x 7.8" x 7.5" / 8.8 lbs

DSF8500 Digital Sender Flow Document Capture Workstation

ITEM NO.
HEWL2762A

\$2,639⁰⁰



- Up to 110 ppm color/grayscale
- Single-pass duplex, 220 ipm
- 150 sheet ADF, 600 dpi
- 8.5" x 14" platen, 34" max scan
- Photo paper, plastic cards
- Up to 10,000 scans daily

- 8" color touchscreen
- Pull-out keyboard
- Multi-feed detect, image correct
- 3584 MB, 2 USB, Ethernet
- TWAIN, WIA, ISIS drivers
- 23" x 20" x 10.4" / 38.5 lbs

SJN9120 Enterprise Flow Flatbed Scanner

ITEM NO.
HEWL2763A

\$5,712⁰⁰



- Up to 120 ppm color/grayscale
- Single-pass duplex, 240 ipm
- 200 sheet ADF, 600 dpi
- Portrait or landscape loading
- 11.7" x 17" platen, 34" max scan

- Up to 20,000 scans daily
- 8" color touchscreen
- Pull-out keyboard
- Auto crop, tone, image correct
- Folder, FTP, e-mail, USB, OCR

- Kofax, Nuance, Readiris, Cardiris
- 3584 MB, 2 USB, Ethernet
- TWAIN, WIA, ISIS drivers
- 25" x 23.7" x 11.3" / 47 lbs



Enabling Success in Education

with **productive**, **secure** and **sustainable** print solutions from Lexmark



Lexmark's output management solutions are deployed in 6 of the nation's 10 largest US public school districts. Lexmark solutions can help enable the Education sector save time, money and the environment through its **productive**, **secure** and **sustainable** solutions.



Productive

Lexmark's smart printers lead the way in delivering productivity enhancing features, using innovative touchscreen technology that can help you manage costs more effectively and work smarter.



Secure

Lexmark makes security an integral part of all products to help create a safer, secure and more productive environment for your school, college or university.



Sustainable

Lexmark is a recognized industry leader for sustainability initiatives and environmental features which allow users to reduce the environmental impact of their printing.



Are you harnessing the full potential of your existing print infrastructure? Lexmark can enable success through smart multifunction print technology, enabling you to be more agile and focus on what you do best - teaching.

Visit www.lexmark.com/education

CX331ADWE *Color Laser Fax, Copier, Printer, Scanner w/Wireless Network and Duplex*

ITEM NO.
LEX40N9070

\$636⁰⁰



- 33.6 Kbps / 3 spp
- Up to 26 cpm / ppm
- Up to 2400 x 600 dpi
- 250 sheet input tray
- 50 sheet ADF
- 8.5" x 14" platen/paper size
- 50,000 page duty cycle

- Automatic duplex printing
- AirPrint, Mopria, Cloud apps
- 2 USB, Gig Ethernet, WiFi
- 512 MB (Windows / Mac)
- 1 year limited warranty
- 22" x 20" x 17" / 50 lbs
- Uses: 20N0H series toners

CX431ADW *Color Laser Fax, Copier, Printer, Scanner w/Wireless Network and Duplex*

ITEM NO.
LEX40N9370

\$832⁷⁶



- 33.6 Kbps / 3 spp
- Up to 26 cpm / ppm
- Up to 2400 x 600 dpi
- 250 sheet tray, 50 page ADF
- 8.5" x 14" platen/paper size
- 75,000 page duty cycle
- Full auto duplex fx/co/pt/sc

- 2.8" color touch screen
- AirPrint, Mopria, Cloud apps
- 2 USB, Gig Ethernet, WiFi
- 1 GB (Windows / Mac)
- 1 year limited warranty
- 13.6" x 16" x 15.5" / 42 lbs
- Uses: 20N1X series toners

CX522ADE *Color Laser Fax, Copier, Printer, Scanner w/Wireless Network and Duplex*

ITEM NO.
LEX42C7360

\$1,019⁰⁰



- 33.6 Kbps / 3 spp
- Up to 35 cpm / ppm
- Up to 2400 x 600 dpi
- 250 sheet tray, 50 page RADF
- 8.5" x 14" platen/paper size
- 85,000 page duty cycle
- Full auto duplex fx/co/pt/sc
- 4.3" e-Task color touch screen

- AirPrint, Mopria, Cloud app
- Mopria & Google Cloud
- 2 USB, Ethernet, WiFi, NFC
- 2048 MB (Windows / Mac)
- 1 year limited warranty
- 18.2" x 17.4" x 23.1" / 60 lbs
- Uses: 78C10 series toners

CX622ADE *Color Laser Fax, Copier, Printer, Scanner w/Wireless Network and Duplex*

ITEM NO.
LEX42C7380

\$1,384³⁰



- 33.6 Kbps / 3 spp
- Up to 40 cpm / ppm
- Up to 2400 x 600 dpi
- 250 sheet tray, 50 page DADF
- 8.5" x 14" platen/paper size
- 100,000 page duty cycle
- Full auto duplex fx/co/pt/sc
- 4.3" e-Task color touch screen

- AirPrint, Mopria, Cloud app
- Mopria & Google Cloud
- 3 USB, Ethernet, WiFi, NFC
- 2048 MB (Windows / Mac)
- 1 year limited warranty
- 18.2" x 17.4" x 23.1" / 60 lbs
- Uses: 78C10 series toners

CX625ADE *Color Laser Fax, Copier, Printer, Scanner w/Wireless Network and Duplex*

ITEM NO.
LEX42C7780

\$1,661⁴⁷



- 33.6 Kbps / 3 spp
- Up to 40 cpm / ppm
- Up to 2400 x 600 dpi
- 250 sheet tray, 100 page DADF
- 8.5" x 14" platen/paper size
- 100,000 page duty cycle
- Full auto duplex fx/co/pt/sc
- 7" e-Task color touch screen

- AirPrint, Mopria, Cloud app
- Mopria & Google Cloud
- 3 USB, Ethernet, WiFi, NFC
- 2048 MB (Windows / Mac)
- 1 year limited warranty
- 18.2" x 17.4" x 24" / 60 lbs
- Uses: 78C10 series toners

LEX42C7880 (CX625ADHE) **\$2,077.23**

CX725DE *Color Laser Fax, Copier, Printer, Scanner w/Wireless Network and Duplex*

ITEM NO.
LEX40C9500

\$3,540⁹⁴



- 33.6 Kbps / 3 spp
- Up to 50 cpm / ppm
- Up to 2400 x 600 dpi
- 100 and 550 sheet trays
- 50 sheet RADF
- 8.5" x 14" platen/paper size
- 150,000 page duty cycle
- Full auto duplex fx/co/pt/sc

- 7" e-Task color touch screen
- AirPrint, Mopria, Cloud app
- Mopria & Google Cloud
- 3 USB, Ethernet, WiFi, NFC
- 2048 MB (Windows / Mac)
- 1 year limited warranty
- 25.5" x 20" x 21" / 99 lbs
- Uses: 74C10 series toners

LEX40C9501 (CX725DHE) **\$3,966.04**
LEX40C9502 (CX725DTHE) **\$4,391.14**

CX825DE *Color Laser Fax, Copier, Printer, Scanner w/Network, Duplex and Trays*

ITEM NO.
LEX42K0040

\$5,479⁵⁹



- 33.6 Kbps / 3 spp
- Up to 55 cpm / ppm
- Up to 2400 x 600 dpi
- 100 and 500 sheet trays

- 150 sheet DADF
- 8.5" x 14" platen/paper size
- 250,000 page duty cycle
- 10" e-Task color touch screen

- AirPrint, Mopria, Cloud apps
- 5 USB, Gig Ethernet, ICS
- 2048 MB (Windows / Linux)
- 1 year on-site repair warranty
- 32" x 22" x 23" / 168 lbs
- Uses: 72K10 series toners

LEX42K0041 (CX825DTE) **\$6,438.79**
LEX42K0042 (CX825DTFE) **\$6,918.39**

CX820DE Color Laser Fax, Copier, Printer, Scanner w/Network and Duplex

ITEM NO.
LEX42K0010

\$4,794⁴⁴



- 33.6 Kbps / 3 spp
- Up to 52 cpm / ppm
- Up to 2400 x 600 dpi
- 100 and 550 sheet trays
- 150 sheet DADF
- 8.5" x 14" platen/paper size
- 200,000 page duty cycle
- Auto duplex copy/print/scan

- 7" e-Task color touch screen
- AirPrint, Mopria, Cloud apps
- 5 USB, Gigabit Ethernet
- 2048 MB (Windows / Linux)
- 1 year on-site repair warranty
- 22" x 23" x 30" / 181 lbs
- Uses: 72K1X series toners

LEX42K0012 (CX820DTE)  **\$6,575.81**

CX860DE Color Laser Fax, Copier, Printer, Scanner w/Network and Duplex

ITEM NO.
LEX42K0070

\$10,755¹⁹



- 33.6 Kbps / 3 spp
- Up to 57 cpm / ppm
- Up to 2400 x 600 dpi
- 100 and 550 sheet trays
- 150 sheet DADF
- 8.5" x 14" platen/paper size
- 350,000 page duty cycle
- Auto duplex copy/print/scan

- 10" e-Task color touch screen
- AirPrint, Mopria, Cloud apps
- 5 USB, Gigabit Ethernet
- 2048 MB (Windows / Linux)
- 1 year on-site repair warranty
- 22" x 23" x 32" / 183 lbs
- Uses: 82K1U series toners

LEX42K0071 (CX860DTE)  **\$12,056.96**
LEX42K0072 (CX860DTE)  **\$12,468.04**

CX920DE Color Laser Fax, Copier, Printer, Scanner w/Network and Duplex

ITEM NO.
LEX32C0350

\$5,541⁸⁷



- 33.6 Kbps / 3 spp
- Up to 25 cpm / ppm
- Up to 2400 x 600 dpi
- 150 and (2) 500 sheet trays
- 100 sheet DADF
- 11" x 17" platen/paper size
- 150,000 page duty cycle
- Full auto duplex fx/co/pt/sc

- 10" e-Task color touch screen
- AirPrint, Mopria, Cloud apps
- 5 USB, Gig Ethernet, ICS
- 2048 MB (Windows / Linux)
- 1 year on-site repair warranty
- 36" x 24" x 27" / 239 lbs
- Uses: 76C00 series toners

CX921DE Color Laser Fax, Copier, Printer, Scanner w/Wireless Network and Duplex

ITEM NO.
LEX32C0200

\$7,482⁰⁷



- 33.6 Kbps / 3 spp
- Up to 35 cpm / ppm
- Up to 2400 x 600 dpi
- 150 and (2) 500 sheet trays
- 100 sheet DADF
- 11" x 17" platen/paper size
- 200,000 page duty cycle
- Full auto duplex fx/co/pt/sc

- 10" e-Task color touch screen
- AirPrint, Mopria, Cloud app
- Mopria & Google Cloud
- 5 USB, Ethernet, WiFi, NFC
- 2048 MB (Windows / Mac)
- 1 year limited warranty
- 36.3" x 24.2" x 27.4" / 240 lbs
- Uses: 76C00 series toners

CX922DE Color Laser Fax, Copier, Printer, Scanner w/Network and Duplex

ITEM NO.
LEX32C0201

\$10,699⁵⁴



- 33.6 Kbps / 3 spp
- Up to 45 cpm / ppm
- Up to 1200 x 1200 dpi
- 150 and (2) 500 sheet trays
- 100 sheet DADF
- 12" x 18" platen/paper size
- 225,000 page duty cycle
- Full auto duplex fx/co/pt/sc

- 10" e-Task color touch screen
- AirPrint, Mopria, Cloud apps
- 5 USB, Gig Ethernet, ICS
- 2048 MB (Windows / Linux)
- 1 year on-site repair warranty
- 49" x 36" x 30" / 293 lbs
- Uses: 76C00 series toners

CX923DTE Color Laser Fax, Copier, Printer, Scanner w/Wireless Network, Duplex and Tray

ITEM NO.
LEX32C0202

\$12,471¹⁶



- 33.6 Kbps / 3 spp
- Up to 55 cpm / ppm
- Up to 2400 x 600 dpi
- 150 and (4) 500 sheet trays
- 100 sheet DADF
- 11" x 17" platen/paper size
- 250,000 page duty cycle
- Full auto duplex fx/co/pt/sc
- 10" e-Task color touch screen

- AirPrint, Mopria, Cloud app
- Mopria & Google Cloud
- 5 USB, Ethernet, WiFi, NFC
- 2048 MB (Windows / Mac)
- 1 year limited warranty
- 48.2" x 24.2" x 27.4" / 297 lbs
- Uses: 76C00 series toners

LEX32C0203 (CX923DXE)  **\$12,886.19**

CX924DXE Color Laser Fax, Copier, Printer, Scanner w/Wireless Network, Duplex and Trays

ITEM NO.
LEX32C0205

\$15,242⁸⁷



- 33.6 Kbps / 3 spp
- Up to 65 cpm / ppm
- Up to 1200 x 1200 dpi
- 150 and (2) 500 sheet trays
- 2,500 sheet tandem tray

- 100 sheet DADF
- 11" x 17" platen/paper size
- 275,000 page duty cycle
- Full auto duplex fx/co/pt/sc
- 10" e-Task color touch screen

- AirPrint, Mopria, Cloud apps
- 5 USB, Gig Ethernet, ICS
- 2048 MB (Windows / Linux)
- 1 year on-site repair warranty
- 59" x 36" x 30" / 370 lbs
- Uses: 76C0H series toners

LEX32C0204 (CX924DTE)  **\$14,827.11**

MX331ADN Laser Fax, Copy, Printer, Scanner w/Network and Duplex

ITEM NO.
LEX29S0150

\$624⁵⁷



- 33.6 Kbps / 3 spp
- Up to 40 cpm / ppm
- Up to 2400 x 600 dpi
- 100 and 250 sheet trays
- 50 sheet ADF
- 8.5" x 14" platen/paper size
- 50,000 page duty cycle

- Automatic duplex printing
- 2.8" color touch panel
- 512 MB, USB, Ethernet
- 1 year limited warranty
- 13" x 16" x 14.5" / 28 lbs
- 55B1000 toner, 55B0ZA0 drum

MX431ADN Laser Fax, Copy, Printer, Scanner w/Network and Duplex

ITEM NO.
LEX29S0200

\$693²⁴



- 33.6 Kbps / 3 spp
- Up to 42 cpm / ppm
- Up to 2400 x 600 dpi
- 100 and 250 sheet trays
- 50 sheet ADF
- 8.5" x 14" platen/paper size
- 80,000 page duty cycle

- Automatic duplex printing
- 2.8" color touch panel
- 512 MB, USB, Gig Ethernet
- 1 year limited warranty
- 13" x 16" x 14.5" / 28 lbs
- 55B1H00 toner, 55B0ZA0 drum

LEX29S0500 (MX431ADW)\$693.24

MX521ADE Laser Fax, Copier, Printer, Scanner w/Wireless Network and Duplex

ITEM NO.
LEX36S0820

\$1,142⁸⁶



- 33.6 Kbps / 3 spp
- Up to 46 cpm / ppm
- Up to 1200 x 1200 dpi
- 100 and 250 sheet trays
- 50 sheet RADF
- 8.5" x 14" platen/paper size
- 120,000 page duty cycle
- Full auto duplex fx/co/pt/sc

- 4.3" e-Task color touch screen
- 3 USB, Gigabit Ethernet
- 1024 MB (Windows / Mac)
- 1 year limited warranty
- 18.8" x 19.3" x 17" / 45.5 lbs
- 56F1000 toner, 56F0ZA0 drum

LEX36S0800 (MX521DE)\$1,015.71

MX522ADHE Laser Fax, Copier, Printer, Scanner w/Wireless Network and Duplex

ITEM NO.
LEX36S0840

\$1,661⁴⁷



- 33.6 Kbps / 3 spp
- Up to 46 cpm / ppm
- Up to 1200 x 1200 dpi
- 100 and 250 sheet trays
- 50 sheet DADF
- 8.5" x 14" platen/paper size
- 120,000 page duty cycle

- Full auto duplex fx/co/pt/sc
- 4.3" e-Task color touch screen
- 3 USB, Gigabit Ethernet
- 2048 MB (Windows / Mac)
- 1 year limited warranty
- 18.8" x 19.3" x 17" / 45.5 lbs
- 56F1000 toner, 56F0ZA0 drum

MX622ADE Laser Fax, Copier, Printer, Scanner w/Network and Duplex

ITEM NO.
LEX36S0900

\$2,077²³



- 33.6 Kbps / 3 spp
- Up to 50 cpm / ppm
- Up to 1200 x 1200 dpi
- 100 and 550 sheet trays
- 100 sheet DADF
- 8.5" x 14" platen/paper size
- 175,000 page duty cycle

- Full auto duplex fx/co/pt/sc
- 7" e-Task color touch screen
- 3 USB, Gigabit Ethernet
- 2048 MB (Windows / Mac)
- 1 year limited warranty
- 21.5" x 19.3" x 18.8" / 49.2 lbs
- 56F1000 toner, 56F0ZA0 drum

LEX36S0920 (MX622ADHE)\$2,492.99

MX721ADE Laser Fax, Copier, Printer, Scanner w/Network and Duplex

ITEM NO.
LEX25B0000

\$3,185⁹¹



- 33.6 Kbps / 3 spp
- Up to 65 cpm / ppm
- Up to 1200 x 1200 dpi
- 100 and 550 sheet trays
- 200 sheet DADF
- 8.5" x 14" platen/paper size
- 300,000 page duty cycle

- Full auto duplex fx/co/pt/sc
- 7" e-Task color touch screen
- 3 USB, Gigabit Ethernet
- 2048 MB (Windows / Mac)
- 1 year limited warranty
- 29.1" x 22" x 22.8" / 97.2 lbs
- 58D1000 toner, 58D0ZA0 drum

LEX25B0003 (MX721ADHE)\$3,601.67

MX722ADE Laser Fax, Copier, Printer, Scanner w/Network and Duplex

ITEM NO.
LEX25B0002

\$4,156⁰¹



- 33.6 Kbps / 3 spp
- Up to 70 cpm / ppm
- Up to 1200 x 1200 dpi
- 100 and 550 sheet trays
- 200 sheet DADF
- 8.5" x 14" platen/paper size
- 350,000 page duty cycle

- Full auto duplex fx/co/pt/sc
- 7" e-Task color touch screen
- 3 USB, Gigabit Ethernet
- 2048 MB (Windows / Mac)
- 1 year limited warranty
- 29.1" x 22" x 22.8" / 97.2 lbs
- 58D1000 toner, 58D0ZA0 drum

LEX25B0001 (MX722ADHE) **\$4,571.77**

MX822ADE Laser Fax, Copier, Printer, Scanner w/Network and Duplex

ITEM NO.
LEX25B2000

\$4,848⁹⁴



- 33.6 Kbps / 3 spp
- Up to 55 cpm / ppm
- Up to 1200 x 1200 dpi
- 100 and (2) 550 sheet trays
- 200 sheet DADF
- 8.5" x 14" platen/paper size
- 300,000 page duty cycle

- Full auto duplex fx/co/pt/sc
- 10" e-Task color touch screen
- 4 USB, Gigabit Ethernet
- 2048 MB (Windows / Mac)
- 1 year limited warranty
- 45.3" x 27" x 27.3" / 147.6 lbs
- 58D1000 toner, 58D0ZA0 drum

LEX25B0601 (MX822ADXE) **\$5,541.87**

MX826ADE Laser Fax, Copier, Printer, Scanner w/Network and Duplex

ITEM NO.
LEX25B0610

\$6,511⁹⁷



- 33.6 Kbps / 3 spp
- Up to 70 cpm / ppm
- Up to 1200 x 1200 dpi
- 100 and (2) 550 sheet trays
- 200 sheet DADF
- 8.5" x 14" platen/paper size
- 350,000 page duty cycle
- Full auto duplex fx/co/pt/sc

- 10" e-Task color touch screen
- 4 USB, Gigabit Ethernet
- 2048 MB (Windows / Mac)
- 1 year limited warranty
- 45.3" x 27" x 27.3" / 147.6 lbs
- 58D1000 toner, 58D0ZA0 drum

LEX25B0611 (MX826ADXE) **\$7,204.90**

MX910DE Laser Fax, Copy, Printer, Scanner w/Network and Duplex

ITEM NO.
LEX26Z0100

\$10,462⁴⁴



- 33.6 Kbps / 3 spp
- Up to 45 cpm / ppm
- Up to 1200 x 1200 dpi
- 150 and (2) 500 sheet trays
- 100 sheet ADF
- 11" x 17" platen/paper size
- 200,000 page duty cycle

- Full auto duplex fx/co/pt/sc
- 10" e-Task color touch panel
- 4 USB, Gig Ethernet, ICS
- 1024 MB, (Windows / Linux)
- 1 year limited warranty
- 35.8" x 24" x 27" / 209 lbs
- 64G0H00 toner, 54G0P00 drum

MX911DTE Laser Fax, Copy, Printer, Scanner w/Network, Duplex and Extra Trays

ITEM NO.
LEX26Z0101

\$14,931⁹¹



- 33.6 Kbps / 3 spp
- Up to 55 cpm / ppm
- Up to 1200 x 1200 dpi
- 150 and (4) 500 sheet trays
- 100 sheet ADF
- 11" x 17" platen/paper size
- 300,000 page duty cycle

- Full auto duplex fx/co/pt/sc
- 10" e-Task color touch panel
- 4 USB, Gig Ethernet, ICS
- 1024 MB, (Windows / Linux)
- 1 year limited warranty
- 45" x 24" x 27" / 266 lbs
- 64G0H00 toner, 54G0P00 drum

MX912DXE Laser Fax, Copy, Printer, Scanner w/Network, Duplex and Tandem Tray

ITEM NO.
LEX26Z0102

\$20,926⁹¹



- 33.6 Kbps / 3 spp
- Up to 65 cpm / ppm
- Up to 1200 x 1200 dpi
- 150 and (2) 500 sheet trays
- 2,500 sheet tandem tray
- 100 sheet ADF
- 11" x 17" platen/paper size
- 300,000 page duty cycle

- Full auto duplex fx/co/pt/sc
- 10" e-Task color touch panel
- 4 USB, Gig Ethernet, ICS
- 1024 MB, (Windows / Linux)
- 1 year limited warranty
- 45" x 24" x 27" / 264 lbs
- 64G0H00 toner, 54G0P00 drum

C3224DW Color Laser Printer w/Wireless Network and Duplex

ITEM NO.
LEX40N9000

\$297⁷³



- Up to 24 ppm black / color
- Up to 600 x 600 dpi
- 250 sheet input tray
- 8.5" x 14" max paper size
- 30,000 page duty cycle
- Automatic duplex printing

- AirPrint, Mopria, Cloud apps
- USB, Ethernet, WiFi
- 256 MB (Windows / Mac)
- 1 year limited warranty
- 22" x 20" x 13" / 42 lbs
- Uses: C3200 series toners

C3326DW Color Laser Printer w/Wireless Network and Duplex

ITEM NO.
LEX40N9010

\$354²⁹



- Up to 26 ppm black / color
- Up to 600 x 600 dpi
- 250 sheet input tray
- 8.5" x 14" max paper size
- 50,000 page duty cycle
- Automatic duplex printing
- AirPrint, Mopria, Cloud apps

- USB, Ethernet, WiFi
- 512 MB (Windows / Linux)
- 1 year limited warranty
- 22" x 20" x 13" / 42 lbs
- Uses: C330H series toners

CS331DW Color Laser Printer w/Wireless Network and Duplex

ITEM NO.
LEX40N9020

\$392⁰⁰



- Up to 26 ppm black / color
- Up to 600 x 600 dpi
- 250 sheet input tray
- 8.5" x 14" max paper size
- 50,000 page duty cycle
- Automatic duplex printing
- AirPrint, Mopria, Cloud apps

- USB, Ethernet, WiFi
- 512 MB (Windows / Linux)
- 1 year on-site repair warranty
- 22" x 20" x 13" / 42 lbs
- Uses: 20N0H series toners

C3426DW Color Laser Printer w/Wireless Network and Duplex

ITEM NO.
LEX40N9310

\$540⁴⁰



- Up to 26 ppm black / color
- Up to 240 x 600 dpi
- 250 sheet input tray
- 8.5" x 14" max paper size
- 50,000 page duty cycle
- Automatic duplex printing

- AirPrint, Mopria, Cloud apps
- USB, Gigabit Ethernet, WiFi
- 512 MB (Windows / Linux)
- 1 year limited warranty
- 16" x 15.5" x 9.6" / 35.5 lbs
- C3210 series toners

CS431DW Color Laser Printer w/Wireless Network and Duplex

ITEM NO.
LEX40N9320

\$545⁷¹



- Up to 26 ppm black / color
- Up to 2400 x 600 dpi
- 250 sheet input tray
- 8.5" x 14" max paper size
- 75,000 page duty cycle
- Automatic duplex printing

- AirPrint, Mopria, Cloud apps
- USB, Gigabit Ethernet, WiFi
- 512 MB (Windows / Linux)
- 1 year on-site repair warranty
- 22" x 20" x 13" / 35.5 lbs
- 20N10 series toners

CS521DN Color Laser Printer w/Network and Duplex

ITEM NO.
LEX42C0060

\$576⁴⁷



- Up to 35 ppm black / color
- Up to 2400 x 600 dpi
- 250 sheet input tray
- 8.5" x 14" max paper size
- 85,000 page duty cycle
- Automatic duplex printing
- PCL5c/6, PostScript 3, PDF

- 2.4" color LCD display
- Mobile device enabled
- 2 USB, Gigabit Ethernet
- 1024 MB (Windows / Mac)
- 1 year limited warranty
- 12.1" x 17.4" x 16.6" / 46 lbs
- Uses: 78C10 series toners

Call Your Sales Representative Today

CS622DE Color Laser Printer w/Network and Duplex

ITEM NO.
LEX42C0080

\$710⁶⁷



- Up to 40 ppm black / color
- Up to 2400 x 600 dpi
- 250 sheet input tray
- 8.5" x 14" max paper size
- 100,000 page duty cycle
- Automatic duplex printing
- PCL5c/6, PostScript 3, PDF

- 4.3" e-Task color touch screen
- Mobile device enabled
- 2 USB, Gigabit Ethernet
- 1024 MB (Windows / Mac)
- 1 year limited warranty
- 12.1" x 17.4" x 16.6" / 46 lbs
- Uses: 78C10 series toners

CS720DE Color Laser Printer w/Network and Duplex

ITEM NO.
LEX40C9100

\$1,273⁷⁴



- Up to 40 ppm black / color
- Up to 2400 x 600 dpi
- 100 and 550 sheet trays
- 8.5" x 14" max paper size
- 120,000 page duty cycle
- Automatic duplex printing
- PCL5c/6, PostScript 3, PDF

- 4.3" e-Task color touch screen
- Mobile device enabled
- 3 USB, Gigabit Ethernet
- 1024 MB (Windows / Linux)
- 1 year limited warranty
- 18.7" x 19.7" x 16.4" / 80 lbs
- Uses: 74C1S series toners

LEX40C9101 (CS720DTE)  **\$1,698.84**

CS725DE Color Laser Printer w/Network and Duplex

ITEM NO.
LEX40C9000

\$1,840⁵⁴



- Up to 50 ppm black / color
- Up to 2400 x 600 dpi
- 100 and 550 sheet trays
- 8.5" x 14" max paper size
- 150,000 page duty cycle
- Automatic duplex printing
- PCL5c/6, PostScript 3, PDF

- 4.3" e-Task color touch screen
- Mobile device enabled
- 3 USB, Gigabit Ethernet
- 1024 MB (Windows / Linux)
- 1 year limited warranty
- 18.7" x 19.7" x 16.4" / 80 lbs
- Uses: 74C1H series toners

LEX40C9001 (CS725DTE)  **\$2,265.64**

CS820DE Color Laser Printer w/Network and Duplex

ITEM NO.
LEX21K0200

\$2,601⁹⁹



- Up to 60 ppm black / color
- Up to 2400 x 600 dpi
- 100 and 550 sheet trays
- 8.5" x 14" max paper size
- 200,000 page duty cycle
- Automatic duplex printing

- 4.3" e-Task color touch screen
- Mobile device enabled
- 4 USB, Gigabit Ethernet
- 1024 MB (Windows / Linux)
- 22" x 20.6" x 21" / 137 lbs
- Uses: 72K1X series toners

LEX21K0150 (CS820DTE)  **\$3,013.07**
LEX21K0250 (CS820DTFE)  **\$3,492.67**

CS921DE Color Laser Printer w/Network and Duplex

ITEM NO.
LEX32C0000

\$3,740²⁶



- Up to 35 ppm black / color
- Up to 1200 x 1200 dpi
- 150 and (2) 500 sheet trays
- 8.5" x 14" max paper size
- 150,000 page duty cycle
- Automatic duplex printing
- PCL5c/6, PostScript 3, PDF

- 4.3" e-Task color touch screen
- Mobile device enabled
- 4 USB, Gigabit Ethernet
- 1024 MB (Windows / Mac)
- 1 year limited warranty
- 30.7" x 24.2" x 29.6" / 195.4 lbs
- Uses: 76C00 series toners

CS923DE Color Laser Printer w/Network and Duplex

ITEM NO.
LEX32C0001

\$5,126¹¹



- Up to 55 ppm black / color
- Up to 1200 x 1200 dpi
- 150 and (2) 500 sheet trays
- 8.5" x 14" max paper size
- 250,000 page duty cycle
- Automatic duplex printing
- PCL5c/6, PostScript 3, PDF

- 4.3" e-Task color touch screen
- Mobile device enabled
- 4 USB, Gigabit Ethernet
- 1024 MB (Windows / Mac)
- 1 year limited warranty
- 30.7" x 24.2" x 29.6" / 195.4 lbs
- Uses: 76C00 series toners

B3340DW Laser Printer w/Wireless Network and Duplex

ITEM NO.
LEX29S0250

- Up to 40 ppm
- Up to 2400 x 600 dpi
- 100 and 250 sheet trays
- 8.5" x 14" max paper size

- 50,000 page duty cycle
- Automatic duplex printing
- AirPrint, Mopria, Cloud apps
- USB, Ethernet, WiFi

\$331⁶³

- 256 MB (Windows / Linux)
- 1 year limited warranty
- 14.5" x 14.3" x 8.7" / 21 lbs
- B341000 toner, 55B0ZA0 drum



MS331DN Laser Printer w/Network and Duplex

ITEM NO.
LEX29S0000

\$337⁵⁹

- Up to 40 ppm
- Up to 2400 x 600 dpi
- 100 and 250 sheet trays
- 8.5" x 14" max paper size
- 50,000 page duty cycle
- Automatic duplex printing

- PCL5c/e, PCL6, PostScript3
- USB, Ethernet
- 256 MB (Windows / Linux)
- 1 year limited warranty
- 14.5" x 14.3" x 8.7" / 21 lbs
- 55B1000 toner, 55B0ZA0 drum



MS431DN Laser Printer w/Network and Duplex

ITEM NO.
LEX29S0050

\$389³⁸

- Up to 42 ppm
- Up to 2400 x 600 dpi
- 100 and 250 sheet trays
- 8.5" x 14" max paper size
- 80,000 page duty cycle
- Automatic duplex printing

- PCL5c/e, PCL6, PostScript3
- USB, Gigabit Ethernet
- 256 MB (Windows / Linux)
- 1 year limited warranty
- 14.5" x 14.3" x 8.7" / 21 lbs
- 55B1000 toner, 55B0ZA0 drum



LEX29S0100 (MS431DW) \$422.63

B3442DW Laser Printer w/Wireless Network and Duplex

ITEM NO.
LEX29S0300

\$392⁸⁸

- Up to 42 ppm
- Up to 2400 x 600 dpi
- 100 and 250 sheet trays
- 8.5" x 14" max paper size
- 80,000 page duty cycle
- Automatic duplex printing

- AirPrint, Mopria, Cloud apps
- USB, Ethernet, WiFi
- 256 MB (Windows / Linux)
- 1 year limited warranty
- 14.5" x 14.3" x 8.7" / 21 lbs
- B341000 toner, 55B0ZA0 drum



MS521DN Laser Printer w/Network and Duplex

ITEM NO.
LEX36S0300

\$761⁴⁴

- Up to 46 ppm
- Up to 1200 x 1200 dpi
- 100 and 250 sheet trays
- 8.5" x 14" max paper size
- 120,000 page duty cycle
- Automatic duplex printing
- PCL5e, PCL6, PostScript 3

- 2.4" color LCD display
- Mobile device enabled
- USB, Gigabit Ethernet
- 512 MB (Windows / Mac)
- 1 year limited warranty
- 10.2" x 15.7" x 14.7" / 31.1 lbs
- 56F1000 toner, 56F0ZA0 drum



MS621DN Laser Printer w/Network and Duplex

ITEM NO.
LEX36S0400

\$1,038⁶¹

- Up to 50 ppm
- Up to 1200 x 1200 dpi
- 100 and 550 sheet trays
- 8.5" x 14" max paper size
- 175,000 page duty cycle
- Automatic duplex printing
- PCL5e, PCL6, PostScript 3

- 2.4" color LCD display
- Mobile device enabled
- 2 USB, Gigabit Ethernet
- 512 MB (Windows / Mac)
- 1 year limited warranty
- 12" x 15.7" x 14.7" / 35 lbs
- 56F1000 toner, 56F0ZA0 drum



MS622DE Laser Printer w/Network and Duplex

ITEM NO.
LEX36S0500

\$1,315⁷⁹

- Up to 50 ppm
- Up to 1200 x 1200 dpi
- 100 and 550 sheet trays
- 8.5" x 14" max paper size
- 175,000 page duty cycle
- Automatic duplex printing
- PCL5e, PCL6, PostScript 3

- 4.3" e-Task color touch screen
- Mobile device enabled
- 3 USB, Gigabit Ethernet
- 1024 MB (Windows / Mac)
- 1 year limited warranty
- 12" x 15.7" x 14.7" / 36 lbs
- 56F1000 toner, 56F0ZA0 drum



MS725DVN Laser Printer w/Network and Duplex

ITEM NO.
LEX50G0610

- Up to 55 ppm
- Up to 1200 x 1200 dpi
- 100 and 550 sheet trays
- 8.5" x 14" max paper size
- 300,000 page duty cycle

- Automatic duplex printing
- PCL5e, PCL6, PostScript 3
- 2.4" color LCD display
- Mobile device enabled
- 2 USB, Gigabit Ethernet

\$1,661⁴⁷

- 512 MB (Windows / Mac)
- 1 year limited warranty
- 17.5" x 16.9" x 20.1" / 56 lbs
- 58D1000 toner, 58D0ZA0 drum



MS821DN Laser Printer w/Network and Duplex

ITEM NO.
LEX50G0100

\$1,315⁷⁹

- Up to 55 ppm
- Up to 1200 x 1200 dpi
- 100 and 550 sheet trays
- 8.5" x 14" max paper size
- 250,000 page duty cycle
- Automatic duplex printing
- PCL5e, PCL6, PostScript 3

- 2.4" color LCD display
- Mobile device enabled
- 2 USB, Gigabit Ethernet
- 512 MB (Windows / Mac)
- 1 year limited warranty
- 17.5" x 16.9" x 20.1" / 56 lbs
- 58D1000 toner, 58D0ZA0 drum



MS822DE Laser Printer w/Network and Duplex

ITEM NO.
LEX50G0110

\$1,592⁹⁶

- Up to 55 ppm
- Up to 1200 x 1200 dpi
- 100 and 550 sheet trays
- 8.5" x 14" max paper size
- 250,000 page duty cycle
- Automatic duplex printing
- PCL5e, PCL6, PostScript 3

- 4.3" e-Task color touch screen
- Mobile device enabled
- 3 USB, Gigabit Ethernet
- 1024 MB (Windows / Mac)
- 1 year limited warranty
- 17.5" x 16.9" x 20.1" / 56.4 lbs
- 58D1000 toner, 58D0ZA0 drum



LEX50G0050 (MS821N)..... \$1,038.61

MS823DN Laser Printer w/Network and Duplex

ITEM NO.
LEX50G0200

\$1,731⁵⁴

- Up to 65 ppm
- Up to 1200 x 1200 dpi
- 100 and 550 sheet trays
- 8.5" x 14" max paper size
- 300,000 page duty cycle
- Automatic duplex printing
- PCL5e, PCL6, PostScript 3

- 2.4" color LCD display
- Mobile device enabled
- 2 USB, Gigabit Ethernet
- 512 MB (Windows / Mac)
- 1 year limited warranty
- 17.5" x 16.9" x 20.1" / 56 lbs
- 58D1000 toner, 58D0ZA0 drum



LEX50G0180 (MS823N)..... \$1,454.37

MS825DN Laser Printer w/Network and Duplex

ITEM NO.
LEX50G0300

\$2,492⁹⁹

- Up to 70 ppm
- Up to 1200 x 1200 dpi
- 100 and 550 sheet trays
- 8.5" x 14" max paper size
- 350,000 page duty cycle
- Automatic duplex printing
- PCL5e, PCL6, PostScript 3

- 2.4" color LCD display
- Mobile device enabled
- 2 USB, Gigabit Ethernet
- 512 MB (Windows / Mac)
- 1 year limited warranty
- 17.5" x 16.9" x 20.1" / 56 lbs
- 58D1000 toner, 58D0ZA0 drum



MS826DE Laser Printer w/Network and Duplex

ITEM NO.
LEX50G0310

\$2,770¹⁶

- Up to 70 ppm
- Up to 1200 x 1200 dpi
- 100 and 550 sheet trays
- 8.5" x 14" max paper size
- 350,000 page duty cycle
- Automatic duplex printing
- PCL5e, PCL6, PostScript 3

- 4.3" e-Task color touch screen
- Mobile device enabled
- 3 USB, Gigabit Ethernet
- 1024 MB (Windows / Mac)
- 1 year limited warranty
- 17.5" x 16.9" x 20.1" / 56.4 lbs
- 58D1000 toner, 58D0ZA0 drum



MS911DE Laser Printer w/Network and Duplex

ITEM NO.
LEX26Z0000

\$4,710³⁶

- Up to 55 ppm
- Up to 1200 x 1200 dpi
- 150 and (2) 500 sheet trays
- 12" x 18" max paper size
- 300,000 page duty cycle
- Automatic duplex printing
- PCL5e, PCL6, PostScript 3

- 4.3" e-Task color touch screen
- Mobile device enabled
- 4 USB, Gigabit Ethernet
- 512 MB (Windows / Mac)
- 1 year limited warranty
- 30.3" x 24.2" x 27.4" / 163 lbs
- 54G0H00 toner, 54G0P00 drum



QQC Compatible Stands

**Top quality,
all metal
copier cabinets
you can afford!**



- Ready-to-assemble stand
- Panels slot and snap into place
- No screws, nuts or bolts required
- Stiffening frame holds up to 480 lbs

- Color coordinated for a perfect match
- Strength and weather tested castors
- Flat pack design reduces shipping costs
- Can be shipped through UPS

Copystar / Kyocera Compatible

Item Code	Size	Color	Dimensions Wx Dx H	Compatible OEM	List
QQCTA3252	11" Low	Black	23.7" x 22.3" x 11"	Copystar / Kyocera	\$197.00
QQCTA406L	12.5" Low	Black	21.6" x 20" x 12.5"	Copystar / Kyocera	\$205.00
QQCTA406H	17.5" Tall	Black	21.6" x 20" x 17.5"	Copystar / Kyocera	\$210.00
QQCM6535	18" Med	Black	15.4" x 20.9" x 17.9"	Copystar / Kyocera	\$190.00
QQCFS6025	13" Low	Black	23.2" x 23.2" x 13.9"	Copystar, Kyocera	\$183.00
QQCTA3110L	3" Low	Black	15" x 16.1" x 3.1"	Copystar, Kyocera	\$154.00
QQCTA3110M	19" Med	Black	15" x 16.1" x 19.3"	Copystar, Kyocera	\$175.00
QQCTA3110H	24" Tall	Black	15" x 16.1" x 24.8"	Copystar, Kyocera	\$175.00
QQCADJ45A	Adjustable	Light Grey	17.5" x 17" x 25"	Lexmark / Kyocera / Generic	\$270.00
QQC1724BK	25" Tall	Black	16.8" x 16.2" x 24.8"	Lexmark / Kyocera / Generic	\$170.00
QQC2020BK	20" Tall	Black	20" x 20" x 20"	Lexmark / Kyocera / Generic	\$175.00
QQC2025BK	25" Tall	Black	20" x 20" x 25"	Lexmark / Kyocera / Generic	\$180.00
QQC1724LG	25" Tall	Light Grey	16.8" x 16.2" x 24.8"	Lexmark / Kyocera / Xerox	\$170.00
QQC2020LG	20" Tall	Light Grey	20" x 20" x 20"	Lexmark / Kyocera / Xerox	\$175.00
QQC2025LG	25" Tall	Light Grey	20" x 20" x 25"	Lexmark / Kyocera / Xerox	\$180.00
QQCLX50-13	13" Low	Light/Dark Grey	17.1" x 21.2" x 13"	Lexmark	\$226.00
QQCLX50-18	18" Med	Light/Dark Grey	17.1" x 21.2" x 18"	Lexmark	\$226.00
QQCCX920	9.9" Low	Light/Dark Grey	17.1" x 21.2" x 18"	Lexmark / Xerox	\$175.00
QQCMH2507	20" Tall	Light Grey	22.2" x 22.7" x 19.6"	Xerox	\$190.00
QQCMH3400	10.6" Low	White	20.1" x 19.6" x 10.6"	Okidata, Toshiba	\$130.00
QQCMH3400H	16" Med	White	20.1" x 19.6" x 16"	Okidata, Toshiba	\$190.00

Call Your Sales Representative Today

MICR Check Printing Solution



The World's Most **Fraud Resistant** Solution on the Market

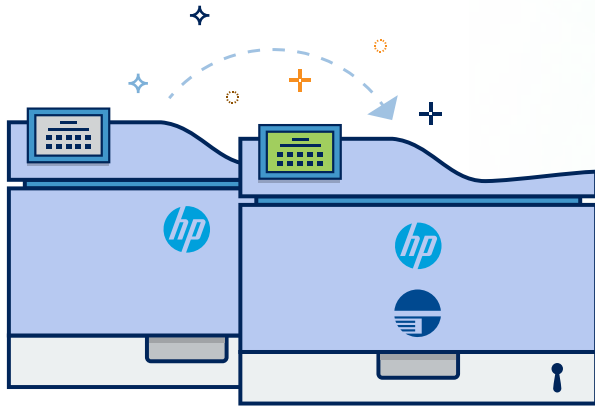

TROY MICR Printers

Includes HP's world class endpoint security, enhanced with 16+ MICR security features.

- ✓ Exact Position Technology
- ✓ Toner Sensing
- ✓ Encryption & Decryption
- ✓ MICR Fonts

TROY MICR Toner Secure™

The World's Most **Fraud Resistant** MICR Toner

Patented security technology releases a red dye if chemical alteration is attempted, voiding the check if fraud is attempted.

- ✓ Meets ANSI & ABA banking standards
- ✓ High-quality & reliable
- ✓ High adhesion for maximum bank readability
- ✓ Toner will not easily scrape/wear off

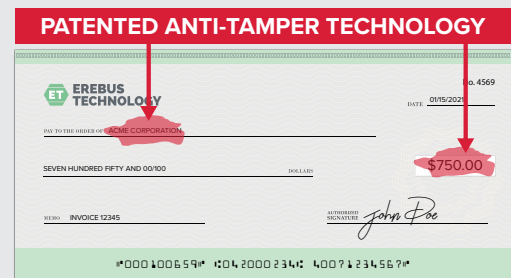

TROY AssurePay Check Printing Software

Range of software for SMB to enterprise, including specialized editions for banks, to meet the needs of your customers.

- ✓ Eliminate security risk of preprinted check stock
- ✓ Robust reporting features
- ✓ Print checks on demand including the account and routing numbers, logos, and signatures

MICR Product List (For Secure Check Printing)

PART #	PRINTERS	TRAYS/LOCKS/PAGES		
01-04910-201	M806dn MICR Printer	2	0	500
01-04910-221	M806dn MICR Printer	2	2	500
01-04920-201	M806dn MICR Secure Printer	2	0	500
01-04920-221	M806dn MICR Secure Printer	2	2	500
01-04930-221	M806dn MICR Secure Ex Printer	2	2	500
01-04950-401	M806x MICR Printer	2 + 1	0 + 0	500 + 3.5K
01-04950-441	M806x MICR Printer	2 + 1	4 + 4	500 + 3.5K
01-04960-401	M806x MICR Secure Printer	2 + 1	0 + 0	500 + 3.5K
01-04960-441	M806x MICR Secure Printer	2 + 1	4 + 4	500 + 3.5K
01-04970-441	M806x MICR Secure Ex Printer	2 + 1	4 + 4	500 + 3.5K
01-06722-101	M612dn MICR Secure Printer	1	0	550
01-06722-111	M612dn MICR Secure Printer	1	1	550
01-06723-111	M612dn MICR Secure Ex Printer	1	1	550
01-06712-101	M611dn MICR Secure Printer	1	0	550
01-06712-111	M611dn MICR Secure Printer	1	1	550
01-06713-111	M611dn MICR Secure Ex Printer	1	1	550
01-06702-101	M610dn MICR Printer	1	0	550
01-06702-111	M610dn MICR Printer	1	1	550
01-04133-211	M528C MICR Secure Printer	2	1	550
01-04131-221	M528C MICR Secure Printer	2	2	550
01-04130-221	M528C MICR Secure Ex Printer	2	2	550
01-04710-101	M507dn MICR Printer	1	0	550
01-04710-111	M507dn MICR Printer	1	1	550
01-04720-101	M507dn MICR Secure Printer	1	0	550
01-04720-111	M507dn MICR Secure Printer	1	1	550
01-04730-111	M507dn MICR Secure Ex Printer	1	1	550
01-00860-101	M404n MICR Printer	1	0	350
01-00860-111	M404n MICR Printer	1	1	350
01-00861-101	M404dn MICR Printer	1	0	350
01-00861-111	M404dn MICR Printer	1	1	350
02-20634-001	M428 mfp MICR Printer	1	0	350
05-00211-001	M428 mfp MICR Printer	1	1	350
01-00871-101	M406dn MICR Printer	1	0	350
01-00871-111	M406dn MICR Printer	1	1	350
01-00985-101	M203dw MICR Printer	1	-	250
01-06200-001	200 Mobile MICR Printer	1	-	50

PART #	MICR Toner Secure (Legacy)	Yield
02-82041-001	M608/M609 MICR Toner Secure HY	25K
02-82040-001	M607/M608/M609 MICR Toner Secure STY	11K
02-82021-001	M605/M606/M630 MICR Toner Secure HY	25K
02-82020-001	M604/M605/M606/M630 MICR Toner Secure STY	10.5K
02-81676-001	M501/M506/M527 mfp MICR Toner Secure HY	18K
02-81675-001	M501/M506/M527 mfp MICR Toner Secure STY	9K
02-81576-001	M402/M426 mfp MICR Toner Secure HY	9K
02-81575-001	M402/M426 mfp MICR Toner Secure STY	3.1K
02-82016-001	M201/M225 MICR Toner Secure HY	2.2K
02-82015-001	M201/M225 MICR Toner Secure STY	1.5K
02-81081-001	9000/9040/9050 MICR Toner Secure STY	35K
02-81351-001	602/603 MICR Toner Secure HY	24K
02-81350-001	601/602/603 MICR Toner Secure STY	10K
02-81601-001	3015/M525 MICR Toner Secure HY	12.5K
02-81600-001	3015/M525 MICR Toner Secure STY	6K
02-81551-001	M401/M425 mfp MICR Toner Secure HY	6.8K
02-81550-001	M401/M425 mfp MICR Toner Secure STY	2.7K
02-82000-001	P1606 MICR Toner Secure STY	2.1K
02-81301-001	4015/4515 MICR Toner Secure HY	24K
02-81300-001	4014/4015/4515 MICR Toner Secure STY	10K
02-81200-001	3005 MICR Toner Secure HY	13K
02-81201-001	3005 MICR Toner Secure STY	6.5K
02-81501-001	2055 MICR Toner Secure HY	6.5K
02-81500-001	2035/2055 MICR Toner Secure STY	2.3K
02-81400-001	P1505 MICR Toner Secure STY	2K
02-81136-001	4250/4350 MICR Toner Secure HY	20K
02-81135-001	4250/4350 MICR Toner Secure STY	12K
02-81134-001	2420/2430 MICR Toner Secure HY	12K
02-81213-001	2015 MICR Toner Secure HY	7K
02-81212-001	2015 MICR Toner Secure STY	2.8K
02-81118-001	4200 MICR Toner Secure STY	13.5K
02-81127-001	2300 MICR Toner Secure STY	6.3K

PART #	MICR Toner Secure (Current)	Yield
02-88000-001	M806 MICR Toner Secure STY	35K
02-W1470X-001	M611/M612 MICR Toner Secure HY	25K
02-W1470A-001	M610/M611/M612 MICR Toner Secure STY	10.5K
02-81681-001	M507/M528 mfp MICR Toner Secure HY	10K
02-81680-001	M507/M528 mfp MICR Toner Secure STY	5K
02-CF258X-001	M404/M428/M406 MICR Toner Secure HY	10K
02-CF258A-001	M404/M428/M406 MICR Toner Secure STY	3K
02-82029-001	M203/M227 mfp MICR Toner Secure HY	3.5K
02-82028-001	M203/M227 mfp MICR Toner Secure STY	1.6K
02-82030-001	M102/M130 mfp MICR Toner Secure STY	1.6K

PART #	Lexmark / Dell / XEROX Certified Precision MICR Toner	Yield
02-72339-001P	ST9630/9650 Precision MICR Toner Secure STY	15K
02-72341-001P	ST9335/9340 Precision MICR Toner Secure STY	14K
02-72347-001P	T520/ST9125 Precision MICR Toner Secure STY	15K
02-72361-001P	Lexmark T640 Precision MICR Toner Secure STY	15K
02-81104-001	Lexmark T520/T522 ST9120/9125 MICR Toner STY	16K
02-72344-001P	ST9530/9550 Precision MICR Toner Secure STY	15K
02-72349-001P	Lexmark T630 Precision MICR Toner Secure STY	21K
02-72360-001P	Lexmark T650 Precision MICR Toner Secure STY	15K
02-72362-001P	Lexmark e250 Precision MICR Toner Secure STY	2.5K
02-81071-001	Lexmark OPTRA T/ ST915/925/935 MICR Toner HY	16K
02-81890-001	Lexmark MS410/610 MICR Toner HY	5K

PART #	MICR Ink (Current)	Yield
02-MC2P05A-062	200 Mobile MICR Ink HY	600
02-MC2P04A-062	200 Mobile MICR Ink STY	200
02-MC9364W-098	100 Portable MICR Ink	420



HY = High Yield | STY = Standard Yield
 Page yield based on 5% continuous print coverage. Subject to change without prior notice.
 Some legacy supplies may have limited quantities, confirm before ordering.



Document Printing Solution



Print Safe. Prevent Document Fraud.



Prevent Theft

Protect important security stock such as checks/money orders, diplomas, vital records, and other high-value paper.



Fraud Protection

Small, proactive steps now reduce your risks of financial loss down the road. Proactively protect high value documents



Protect Your Reputation

Prevent fraud that could likely harm your reputation far faster than you built it.

TROY Security Toner Uses Patented Anti-Tamper Technology that Prevents Data Alteration.

The primary purpose of security toner is to **easily add a layer of security** to your printed documents.

This hidden layer of security is **a red dye within the toner that is released if chemical alteration** is attempted to change your valuable data.

This ruins the document, stopping fraudsters who attempt to alter data, such as names, amounts, grades, medications, or prescription quantities, etc.

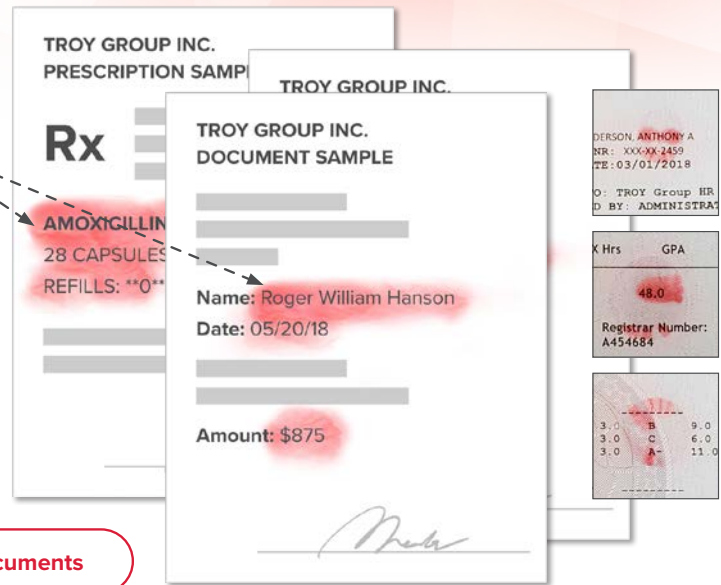

Prescriptions

Healthcare Forms

Legal Documents

Diplomas

Transcripts

Deeds & Titles

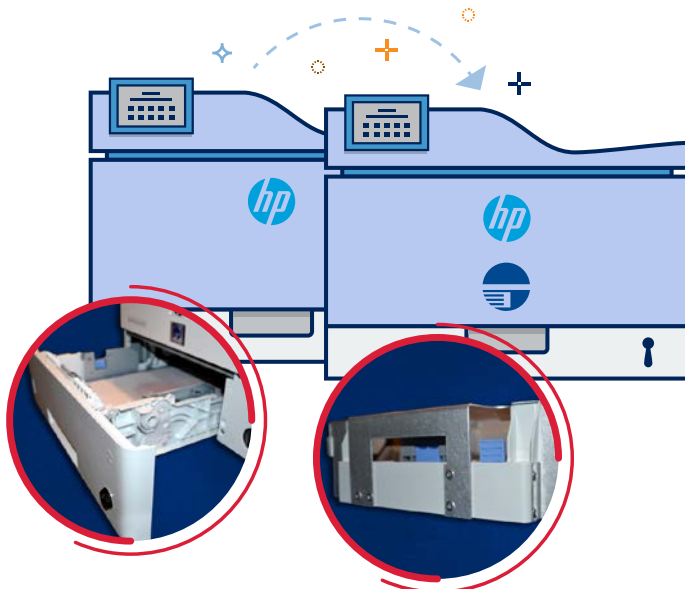

TROY Locking Printers

Ideal for organizations with **shared printers that are accessible to multiple people** including patients, customers, or even employees.

Implementing a locking printer solution can drastically **reduce the risk for corruption, fraud, or forgery.**

- ✔ Locks engineered to fit your specific printer
- ✔ Rugged aluminum shielding prevents paper theft from the top of the tray and rear of the printer.

Non-MICR Product List (For Secure Document Printing)

PART #	TONER	YIELD ¹			
02-88000-700	M806 Security Toner STY	35K			
02-W1470X-700	M611/M612 Security Toner HY	25K			
02-W1470A-700	M610/M611/M612 Security Toner STY	10.5K			
02-81681-700	M507/M527 mfp Security Toner HY	10K			
02-81680-700	M507/M527 mfp Security Toner STY	5K			
02-CF258X-700	M404/M428/M406 mfp Security Toner HY	10K			
02-CF258A-700	M404/M428/M406 mfp Security Toner STY	3K			
02-82041-700	M608/M609 Security Toner HY	25K			
02-82040-700	M607/M608/M609 Security Toner STY	11K			
02-81081-700	9000/9040/9050 Security Toner STY	35K			
02-82021-700	M605/M606 Security Toner HY	25K			
02-82020-700	M604/M605/M606 Security Toner STY	10.5K			
02-81676-700	M506/M527 mfp Security Toner HY	18K			
02-81675-700	M506/M527 mfp Security Toner STY	9K			
02-81576-700	M402/M426 mfp Security Toner HY	9K			
02-81575-700	M402/M426 mfp Security Toner STY	3.1K			
02-81351-700	M602/M603 Security Toner HY	24K			
02-81350-700	M601/M602/M603 Security Toner STY	10K			
02-81601-700	P3015 Security Toner HY	12.5K			
02-81600-700	P3015 Security Toner STY	6K			
02-81551-700	M401/M425 mfp Security Toner HY	6.8K			
02-81550-700	M401/M425 mfp Security Toner STY	2.7K			
02-81301-700	4015/4515 Security Toner HY	24K			
02-81300-700	4014/4015/4515 Security Toner STY	10K			
PART #	PRINTERS	VOLTS	TRAYS	PAGES	LOCKS
01-04980-441	M806x Locking Printer	110	4	3.5K	4
01-04938-221	M806dn Locking Printer	110	2	550	2
01-06720-111	M612dn Locking Printer	110	1	550	1
01-06710-111	M611dn Locking Printer	110	1	550	1
01-06700-111	M610dn Locking Printer	110	1	550	1
01-06701-111	M610dn Locking Printer - Combination Lock	110	1	550	1
01-04132-221	M528c Locking Printer	110	2	550	2
01-04740-111	M507dn Locking Printer	110	1	550	1
01-00866-111	M404dn Locking Printer	110	1	350	1
01-00865-111	M404n Locking Printer	110	1	350	1
01-00867-111	M428 mfp Locking Printer	110	1	350	1
01-00876-111	M406 mfp Locking Printer	110	1	350	1



1. Page yield based on 5% continuous print coverage
 HY = High Yield | STY = Standard Yield
 Subject to change without prior notice.



B205NI Laser Copier, Printer, Scanner w/Wireless Network

ITEM NO.
XERB205NI

\$255⁰⁰



- Up to 31 cpm / ppm
- Up to 1200 x 1200 dpi
- 250 sheet input tray
- 40 sheet ADF
- 8.5" x 14" max paper size
- 30,000 page duty cycle

- AirPrint, Mopria, Cloud apps
- USB, Ethernet, WiFi direct
- 256 MB (Win / Mac / Linux)
- 1 year limited warranty
- 15.8" x 14.4" x 14.3" / 24 lbs
- Uses: XER06R04346 toner

WC3335DNI WorkCentre Laser Fax, Copier, Printer, Scanner w/Wireless Network and Duplex

ITEM NO.
XERWC3335DNI

\$430⁰⁰



- 33.6 Kbps / 200 dials
- Up to 35 cpm / ppm
- Up to 1200 x 1200 dpi
- 50 and 250 sheet trays
- 50 page ADF
- 8.5" x 11.7" platen; 14" paper
- 50,000 page duty cycle

- Automatic duplex printing
- 4.3" color touchscreen
- AirPrint, Mopria, Cloud apps
- USB, Ethernet, WiFi direct
- 1.5 GB (Win/Mac/Linux)
- 16.3" x 16.6" x 17.7" / 34 lbs
- Uses: XER106R03620 toner

B215DNI Laser Fax, Copier, Printer, Scanner w/Wireless Network and Duplex

ITEM NO.
XERB215DNI

\$310⁰⁰



- E-mail and fax capabilities
- Up to 31 cpm / ppm
- Up to 1200 x 1200 dpi
- 250 sheet input tray
- 40 sheet ADF
- 8.5" x 14" max paper size
- 30,000 page duty cycle

- Automatic duplex printing
- 3.5" color touchscreen
- AirPrint, Mopria, Cloud apps
- USB, Ethernet, WiFi direct
- 256 MB (Win/Mac/Linux)
- 15.8" x 14.4" x 15.6" / 25 lbs
- Uses: XER06R04347 toner

WC3345DNI WorkCentre Laser Fax, Copier, Printer, Scanner w/Wireless Network and Duplex

ITEM NO.
XERWC3345DNI

\$550⁰⁰



- 33.6 Kbps / 200 dials
- Up to 42 cpm / ppm
- Up to 1200 x 1200 dpi
- 50 and 250 sheet trays
- 50 page RADF
- 8.5" x 11.7" platen; 14" paper
- 80,000 page duty cycle

- Automatic duplex co/pt/sc
- 4.3" color touchscreen
- AirPrint, Mopria, Cloud apps
- USB, Ethernet, WiFi direct
- 1.5 GB (Win/Mac/Linux)
- 18.5" x 17.7" x 19" / 38 lbs
- Uses: XER106R03620 toner

B405DN VersaLink Laser Fax, Copier, Printer, Scanner w/Network and Duplex

ITEM NO.
XERB405DN

\$1,069⁰⁰



- 33.6 Kbps / 2,000 contacts
- Up to 47 cpm / ppm
- Up to 1200 x 2400 dpi
- 150 and 550 sheet trays
- 60 page RADF
- 8.5" x 14" max paper size
- 110,000 page duty cycle

- Automatic duplex co/pt/sc
- 5" color touchscreen
- AirPrint, Mopria, Cloud apps
- 2 USB, Ethernet, NFC
- 2 GB (Win/Mac/Linux)
- 19.5" x 19.5" x 21.7" / 48 lbs
- XER106R0358x series toners

XERB405YDN (TAA).....\$1,059.00

WC6515DN WorkCentre Color Laser Fax, Copier, Printer, Scanner w/Network and Duplex

ITEM NO.
XERWC6515DN

\$780⁰⁰



- 33.6 Kbps / 200 dials
- Up to 30 cpm / ppm
- Up to 1200 x 2400 dpi
- 50 and 250 sheet trays
- 50 page DADF
- 8.5" x 11.7" platen; 14" paper
- 50,000 page duty cycle

- Automatic duplex co/pt/sc
- Customize color touchscreen
- AirPrint, Mopria, Cloud apps
- 2 USB, Gigabit Ethernet
- 2 GB (Win/Mac/Linux)
- 16.5" x 19.7" x 19.9" / 67.6 lbs
- XER106R0347x series toners

XERWC6515DNI (TAA)\$805.00

C405DN Versalink Color Laser Fax, Copier, Printer, Scanner w/Network and Duplex

ITEM NO.
XERC405DN

\$1,249⁰⁰



- 33.6 Kbps / 2,000 contacts
- Up to 36 ppm
- Up to 600 x 600 dpi
- 150 and 550 sheet trays

- 50 sheet DADF
- 8.5" x 14" max paper size
- 80,000 images per month
- Automatic duplex printing

- 5" custom color touchscreen
- ConnectKey technology
- 2 USB, Gig Ethernet, NFC
- 2 GB (Win / Mac / Linux)
- 19.3" x 19.2" x 15.7" / 57 lbs
- XER106R0351x series toner

XERC405YDN (TAA).....\$1,170.00

B210DNI Laser Printer w/Wireless Network and Duplex

ITEM NO.
XERB210DNI

\$189⁰⁰



- Up to 31 ppm
- Up to 1200 x 1200 dpi
- 250 sheet input tray
- 8.5" x 14" max paper size
- 30,000 page duty cycle
- Automatic duplex printing
- PCL5, PCL6, PostScript3

- AirPrint, Mopria, Cloud apps
- USB, Ethernet, WiFi direct
- 256 MB (Windows / Mac)
- 1 year limited warranty
- 14.5" x 8.4" x 13.2" / 16.7 lbs
- Uses: XER106R04346 toner

PH6510DN Phaser Color Laser Printer w/Network and Duplex

ITEM NO.
XERPH6510DN

\$530⁰⁰



- Up to 30 ppm black / color
- Up to 1200 x 2400 dpi
- 50 and 250 sheet trays
- 8.5" x 14" max paper size
- 50,000 pages per month
- Automatic duplex printing

- AirPrint, Mopria, Cloud apps
- 2 USB, Gigabit Ethernet
- 1 GB (Win / Mac / Lunix)
- 16.5" x 13.7" x 19" / 52.5 lbs
- XER106R0347x series toners

XERPH6510DNI..... **\$557.00**

B400DN Versalink Laser Printer w/Network and Duplex

ITEM NO.
XERB400DN

\$835⁰⁰



- Up to 47 ppm
- Up to 1200 x 1200 dpi
- 150 and 550 sheet trays
- 8.5" x 14" max paper size
- 150,000 images per month
- Automatic duplex printing

- 5" custom color touchscreen
- ConnectKey technology
- 2 USB, Ethernet, NFC
- 2 GB (Windows / Mac)
- 18" x 16.8" x 13.3" / 30 lbs
- Uses: XER106R03580 toner

XERB400YDN (TAA)..... **\$835.00**

C400DN Versalink Color Laser Printer w/Network and Duplex

ITEM NO.
XERC400DN

\$755⁰⁰



- Up to 36 ppm black / color
- Up to 600 x 600 dpi
- 150 and 550 sheet trays
- 50 sheet DADF
- 8.5" x 14" max paper size
- 80,000 pages per month
- Automatic duplex printing

- 5" custom color touchscreen
- ConnectKey technology
- 2 USB, Gig Ethernet, NFC
- 2 GB (Win / Mac / Linux)
- 19.3" x 19.2" x 15.7" / 57 lbs
- XER106R0351x series toner

XERC400YDN (TAA)..... **\$755.00**

B600DN Versalink Laser Printer w/Network and Duplex

ITEM NO.
XERB600DN

\$1,059⁰⁰



- Up to 58 ppm
- Up to 1200 x 1200 dpi
- 150 and 550 sheet trays
- 8.5" x 14" max paper size
- 300,000 pages per month
- Automatic duplex printing
- 5" custom color touchscreen

- ConnectKey technology
- Solutions & Cloud enabled
- 2 USB, Gig Ethernet, NFC
- 2 GB (Windows / Mac)
- 18.3" x 16.8" x 17.5" / 49 lbs
- Uses: XER106R03940 toner

XERB600YDN (TAA)..... **\$1,059.00**

C500DN Color Laser Printer w/Network and Duplex

ITEM NO.
XERC500DN

\$936⁰⁰



- Up to 45 ppm black / color
- Up to 1200 x 2400 dpi
- 150 and 550 sheet trays
- 8.5" x 14" max paper size
- 120,000 page duty cycle
- Automatic duplex printing

- 5" color touchscreen
- AirPrint, Mopria, Cloud apps
- 2 USB, Ethernet, NFC
- 2 GB (Windows / Mac)
- 16.9" x 18.4" x 17.5" / 61 lbs
- XER106R0386x series toners

XERC500YDN (TAA)..... **\$936.00**

B610DN Versalink Laser Printer w/Network and Duplex

ITEM NO.
XERB610DN

\$1,320⁰⁰



- Up to 65 ppm
- Up to 1200 x 1200 dpi
- 150 and 550 sheet trays
- 8.5" x 14" max paper size
- 300,000 pages per month
- Automatic duplex printing
- 5" custom color touchscreen

- ConnectKey technology
- Solutions & Cloud enabled
- 2 USB, Ethernet, NFC
- 2 GB (Windows / Mac)
- 18.3" x 16.8" x 17.5" / 49 lbs
- Uses: XER106R03940 toner

XERB610YDN (TAA)..... **\$1,320.00**

C600DN Color Laser Printer w/Network and Duplex

ITEM NO.
XERC600DN

\$1,359⁰⁰



- Up to 55 ppm black / color
- Up to 1200 x 2400 dpi
- 150 and 550 sheet trays
- 8.5" x 14" max paper size
- 120,000 page duty cycle
- Automatic duplex printing

- 5" color touchscreen
- AirPrint, Mopria, Cloud apps
- 2 USB, Ethernet, NFC
- 2 GB (Windows / Mac)
- 16.9" x 18.4" x 17.5" / 64.8 lbs
- XER106R0389x series toners

XERC600YDN (TAA)..... **\$1,359.00**

TA-20 *Wide Format Desktop Printer w/Wireless Network*

ITEM NO.
CNM3659C002



\$1,155⁰⁰



- 24" wide print carriage
- Up to 2400 x 1200 dpi
- 5 color pigment ink system
- 104 posters/hour (24" x 36")
- 8" to 24" wide rolls
- 5.9" diameter, 2" or 3" core
- 17" x 63" max cut sheet

- HP GL/2, HP RTL, JPEG
- USB, Gig Ethernet, WiFi
- 2 GB (Windows / Mac)
- 1 year limited warranty
- 39" x 30" x 18" / 82 lbs
- PFI-030 series inks

TM-200 *imagePROGRAF Large Format*

ITEM NO.
CNM3062C006



\$2,310⁰⁰



- 24" wide print carriage
- Up to 2400 x 1200 dpi
- Lucia TD Pigment Ink System
- 24" x 63" max paper
- 24" x 59" max roll paper
- Borderless print w/roll media
- USB Thumb Drive Printing
- 3" color touchscreen display

- Dual-blade rotary cutter
- L-COA PRO, Apple AirPrint
- USB, Ethernet, WiFi
- 2 GB (Windows / Mac)
- 1 year limited warranty
- 42" x 38" x 34" / 112 lbs
- PFI-120 or 320 series inks

CNM3062C002 (TM-200 w/stand) **\$2,630.00**
CNM3062C008 (TM-200 w/L24ei scanner) **\$4,945.00**

TA-30S *Wide Format Printer w/Stand*

ITEM NO.
CNM3661C002



\$3,680⁰⁰



- 36" wide print carriage
- Up to 2400 x 1200 dpi
- 5 color pigment ink system
- 113 posters/hour (24" x 36")
- 8" to 36" wide rolls
- 5.9" diameter, 2" or 3" core
- 17" x 63" max cut sheet
- HP GL/2, HP RTL, JPEG

- Stand with catch basket
- USB, Gig Ethernet, WiFi
- 2 GB (Windows / Mac)
- 1 year limited warranty
- 51" x 42" x 35" / 117 lbs
- PFI-030 series inks

TM-300 *imagePROGRAF Wide Format Printer*

ITEM NO.
CNM3058C002



\$4,735⁰⁰



- 36" wide print carriage
- Up to 2400 x 1200 dpi
- 5 color Lucia TD inks
- 144 D-size prints/hour
- 8" to 36" wide rolls
- 5.9" diameter, 2" or 3" core
- 36" x 63" max cut sheet
- Borderless print w/roll media
- 3" color touchscreen panel

- Dual-blade rotary cutter
- Stand and catch basket
- USB, Gig Ethernet, WiFi
- 2 GB (Windows / Mac)
- 1 year limited warranty
- 51" x 42" x 32" / 130 lbs
- PFI-120 or 320 series inks

CNM3058C010 (w/L36ei scanner + monitor) **\$7,430.00**

GP-300 *imagePROGRAF Large Format Printer w/Stand*

ITEM NO.
CNM5251C002



\$5,295⁰⁰



- 36" wide print carriage
- Up to 2400 x 1200 dpi
- 5 color pigment ink system
- Plus Fluorescent Pink ink
- PANTONE Calibrated
- 8" to 39" wide rolls
- 5.9" diameter, 2" or 3" core
- USB thumb drive printing

- Dual-blade rotary cutter
- Stand with catch basket
- Radiant Infusion layering
- USB, Gig Ethernet, WiFi
- 500GB HD (Windows / Mac)
- 1 year limited warranty
- 51" x 35" x 42" / 130 lbs
- PFI-120, 320 series inks

TM-305 *imagePROGRAF Large Format*

ITEM NO.
CNM3056C002



\$5,260⁰⁰



- 36" wide print carriage
- Up to 2400 x 1200 dpi
- Lucia TD Pigment Ink System
- 36" x 63" max paper
- 36" x 59" max roll paper
- Borderless print w/roll media
- USB Thumb Drive Printing
- 3" color touchscreen display

- Dual-blade rotary cutter
- L-COA PRO, Apple AirPrint
- 2 GB, USB, Ethernet, WiFi
- 500 GB HDD (Windows / Mac)
- 1 year limited warranty
- 42" x 51" x 35" / 134 lbs
- PPFI-120 or 320 series inks

PRO-2100 *imagePROGRAF Large Format Fine Art Printer*

ITEM NO.
CNM3867C002

\$3,255⁰⁰



- 24" wide print carriage
- Up to 2400 x 1200 dpi
- 12 color Lucia PRO inks
- 8" to 24" wide rolls
- 6.7" diameter, 2" or 3" core
- 24" x 59" max cut sheet
- Automatic media loading
- USB thumb drive printing

- 4.3" color touchscreen display
- L-COA PRO, SGRaster
- Multipositional basket
- USB, Gig Ethernet, WiFi
- 320 GB HD (Windows / Mac)
- 1 year limited warranty
- 46" x 43.7" x 38.7" / 223 lbs
- PFI-1100, 1300, 1700 series

TX-3100 *imagePROGRAF Large Format Printer w/Basket*

ITEM NO.
CNM5515C002

\$6,205⁰⁰



- 36" wide print carriage
- Up to 2400 x 1200 dpi
- 5 color LUCIA ink system
- 4.3" LCD touch screen
- 190 D Prints per hour
- 5.9" diameter, 2" or 3" core
- Intelligent Media Handling
- Multipositional catch basket

- USB thumb drive printing
- Dual-blade rotary cutter
- PosterArtist Lite software
- 2GB, USB, Ethernet, WiFi
- 500GB HD (Windows / Mac)
- 90 day limited warranty
- 46" x 55" x 39" / 231 lbs
- PFI-110, 310, 710 series inks

CNM5515C001 (TX-3100 w/Stacker) \$6,310.00

PRO-4100 *imagePROGRAF Large Format Fine Art Printer*

ITEM NO.
CNM3869C002

\$6,310⁰⁰



- 44" wide print carriage
- Up to 2400 x 1200 dpi
- 12 color Lucia PRO inks
- 8" to 44" wide rolls
- 6.7" diameter, 2" or 3" core
- 44" x 59" max cut sheet
- Automatic media loading
- USB thumb drive printing
- 4.3" color touchscreen display

- L-COA PRO, SGRaster
- Multipositional basket
- USB, Gig Ethernet, WiFi
- 320 GB HDD (Windows / Mac)
- 90 day limited warranty
- 62.7" x 46" x 38.7" / 271 lbs
- PFI-1100, 1300, 1700 series

TX-4100 *imagePROGRAF Large Format Printer w/Stacker*

ITEM NO.
CNM5516C001

\$6,835⁰⁰



- 44" wide print carriage
- Up to 2400 x 1200 dpi
- 5 color LUCIA ink system
- 4.3" LCD touch screen
- 190 D Prints per hour
- Free-size borderless print
- 6.7" diameter, 2" or 3" core
- Intelligent Media Handling
- 100 sheet stacker included

- USB thumb drive printing
- Dual-blade rotary cutter
- PosterArtist Lite software
- 2GB, USB, Ethernet, WiFi
- 500GB HD (Windows / Mac)
- 90 days limited warranty
- 46" x 63" x 47" / 278 lbs
- PFI-110, 310, 710 series inks

CNM5516C002 (TX-4100 w/Basket) \$6,370.00

PRO-4100S *imagePROGRAF Wide Format Signage Printer*

ITEM NO.
CNM3873C002

\$5,255⁰⁰



- 44" wide print carriage
- Up to 2400 x 1200 dpi
- 8 color Lucia PRO inks
- 8" to 44" wide rolls
- 6.7" diameter, 2" or 3" core
- 44" x 59" max cut sheet
- Automatic media loading
- USB thumb drive printing
- 4.3" color touchscreen display

- L-COA PRO, SGRaster
- Multipositional basket
- USB, Gig Ethernet, WiFi
- 500 GB HDD (Windows / Mac)
- 1 year limited warranty
- 62.7" x 46" x 38.7" / 267 lbs
- PFI-1100, 1300, 1700 series

PRO-6100S *imagePROGRAF Professional Signage Printer*

ITEM NO.
CNM3875C005

\$10,525⁰⁰



- 60" wide print carriage
- Up to 2400 x 1200 dpi
- 8 color Lucia PRO inks
- 8" to 60" wide rolls
- 6.7" diameter, 2" or 3" core
- 60" x 59" max cut sheet
- Multifunction roll system
- Intelligent media loading
- USB thumb drive printing

- 4.3" color touchscreen display
- L-COA PRO, SGRaster
- Multipositional basket
- USB, Gig Ethernet, WiFi
- 500 GB HD (Windows / Mac)
- 1 year limited warranty
- 78.7" x 46" x 38.7" / 358 lbs
- PFI-1100, 1300, 1700 series

CNM3871C005 (PRO-6100) \$12,630.00

T3170 SureColor Wide Format Desktop Printer w/Wireless Network

ITEM NO.
EPSSCT3170SR

\$1,345⁰⁰



- 24" wide print carriage
- Up to 2400 x 1200 dpi
- A1/D prints in 34 seconds
- 4 color pigment ink system
- PrecisionCore TFP tech
- 11" x 17" auto paper feed
- 13"- 24" wide rolls, 2" core

- 4.3" color touchscreen
- Mobile enabled, USB, WiFi
- Gig Ethernet, WiFi Direct
- Windows / Mac
- 1 year limited warranty
- 38" x 20" x 9" / 60 lbs
- Uses: T40W series inks

T3470 SureColor Wide Format Workgroup Printer w/Wireless Network

ITEM NO.
EPSSCT3470SR

\$2,245⁰⁰



- 24" wide print carriage
- Up to 2400 x 1200 dpi
- A1/D prints in 25 seconds
- 4 color pigment ink system
- PrecisionCore MicroTFP
- 10- 24" wide rolls, 2- 3" core
- 4.3" color touchscreen

- Mobile enabled, USB, WiFi
- Gig Ethernet, WiFi Direct
- Stand with catch basket
- 1 year limited warranty
- 43" x 42" x 30" / 141 lbs
- Uses: T41W series inks

T3270 SureColor Wide Format Single Roll Enterprise Printer

ITEM NO.
EPSSCT3270SR

\$3,050⁰⁰



- 24" wide print carriage
- Up to 2880 x 1440 dpi
- A1/D prints in 28 seconds
- 5 color pigment ink system
- PrecisionCore TFP tech
- 10" to 24" wide rolls
- 5.9" diameter, 2" or 3" core

- Cut sheet 8.3" to 24" wide
- USB, Gigabit Ethernet
- Fast internal rotary cutter
- Stand with stacking basket
- 1 year limited warranty
- 44" x 42" x 30" / 148 lbs
- Uses: T694 series inks

T5270 SureColor Wide Format Single Roll Enterprise Printer

ITEM NO.
EPSSCT5270SR

\$3,995⁰⁰



- 36" wide print carriage
- Signage, tech drawings
- Up to 2880 x 1440 dpi
- A1/D prints in 25 seconds
- 5 color pigment ink system
- PrecisionCore TFP tech
- Gloss, matte, posterboard
- 10" to 36" wide rolls

- 5.9" diameter, 2" or 3" core
- Cut sheet 8.3" to 36" wide
- USB, Gigabit Ethernet
- Fast internal rotary cutter
- Stand with stacking basket
- 1 year limited warranty
- 56" x 30" x 45" / 186 lbs
- Uses: T694 series inks

T7270 SureColor Wide Format Single Roll Enterprise Printer

ITEM NO.
EPSSCT7270SR

\$4,995⁰⁰



- 44" wide print carriage
- Color LCD control panel
- Up to 2880 x 1440 dpi
- A1/D prints in 25 seconds
- 5 color pigment ink system
- 720 nozzles per color
- PrecisionCore TFP tech
- 10" to 44" wide rolls

- 3 to 59 mil media thickness
- 5.9" diameter, 2" or 3" core
- Cut sheet 8.3" to 44" wide
- USB, Gigabit Ethernet
- Fast internal rotary cutter
- High capacity catch basket
- 64" x 45" x 30" / 203 lbs
- Uses: T694 series inks

T5270D SureColor Wide Format Dual Roll Enterprise Printer

ITEM NO.
EPSSCT5270DR

\$5,995⁰⁰



- 36" wide print carriage
- CAD/GIS/Tech drawings
- Up to 2880 x 1440 dpi
- A1/D prints in 25 seconds
- Up to 739.5 sq ft/hour
- 5 color UltraChrome XD ink
- PrecisionCore TFP printhead
- Load 2 different media types

- Automatic roll switching
- 2" or 3" adjustable adapters
- Cut sheet 8.3" to 36" wide
- USB, Gigabit Ethernet
- Fast internal rotary cutter
- Stand with stacking basket
- 56" x 30" x 45" / 261 lbs
- Uses: T694 series inks

T7270D SureColor Wide Format Dual Roll Enterprise Printer

ITEM NO.
EPSSCT7270DR

\$6,995⁰⁰



- 44" wide print carriage
- CAD/GIS/Line drawings
- Up to 2880 x 1440 dpi
- A1/D prints in 25 seconds
- Up to 739.5 sq ft/hour
- 5 color UltraChrome XD ink

- PrecisionCore TFP printhead
- Load 2 different media types
- Automatic roll switching
- 2" or 3" adjustable adapter
- Cut sheet 8.3" to 44" wide
- USB, Gigabit Ethernet

- Fast internal rotary cutter
- High capacity catch basket
- 64" x 45" x 30" / 294 lbs
- Uses: T694 series inks

Call Your Sales Representative Today

Alexis 27 Professional Roll Laminator

ITEM NO.
RSIALEXIS27

\$3,900⁰⁰



- Wide 27" throat entry
- Ideal for schools, print shops
- Posters, banners and signs
- 10 minute warm-up time
- Easy use digital control panel
- 9 step speed control
- Variable 8.2 per minute
- Pivoting table and heat shield

- Built-in rear cross cutter
- Reverse function & guides
- 4 easy clean silicone rollers
- Exit hooks reduce static cling
- Uses 1.5 or 3 mil film rolls
- 1 yr warranty, 6 mo on rollers
- 36" x 20" x 135" / 110 lbs

RSL-2702S Roll Laminator

ITEM NO.
RSIRSL2702S

\$5,600⁰⁰



- Wide 27" throat size
- Ideal for sign & print shops
- Posters, banners, signs
- Easy use soft touch keypad
- Preset temperature controls
- 10 speed setting options
- Gap adjust up to 6/25"

- Built-in rear cross cutter
- Main roller safety cover
- Reverse function & auto-off
- Variable 7.9' per minute
- 1 year limited warranty
- 31" x 24.5" x 16.5" / 27 lbs

RSC-820CLS Wide Format Cold Roll Laminator

ITEM NO.
RSIRSC820CLS

\$4,500⁰⁰



- Wide 32" throat size
- Variable 8.2' per minute
- Accepts 1-10 mil film
- Cold pressure sensitive
- Mounting up to 9/32" thick
- Auto grip 3" core size
- 9 speed setting options

- Quick notch gap/grip adjust
- Reverse function & guides
- Built-in rear cross cutter
- Stand, foot control, cover
- 1 year limited warranty
- 43" x 41" x 21" / 154 lbs

RSC-1401CLTW Wide Format Cold Roll Laminator

ITEM NO.
RSIRSC1401CLTW

\$6,600⁰⁰



- Wide 55" throat size
- Variable 16.4' per minute
- Accepts 1-10 mil film
- Cold pressure sensitive
- Mounting up to 5/8" thick
- Auto grip 3" core size
- 9 speed setting options

- Quick notch gap/grip adjust
- Reverse function & guides
- Built-in rear cross cutter
- Stand and foot control
- 1 year limited warranty
- 67" x 43" x 22" / 188 lbs

RSH-1151 Dual Thermal & Cold Roll Laminator

ITEM NO.
RSIRSH1151

\$15,800⁰⁰



- Wide 45" throat size
- 13' per minute cold
- 9.8' per minute hot
- 20 minute warm-up
- Accepts 1-10 mil film
- Cold pressure sensitive
- Silicone rubber hot rollers
- 2 sided encapsulation
- Mounting up to 5/8" thick

- Auto grip 2.25", 3" core size
- 9 programmable speed sets
- Standby & auto-off modes
- Reverse function & guides
- Built-in rear cross cutter
- Stand, foot control, cover
- 1 year limited warranty
- 59" x 48" x 26" / 363 lbs

RSH-1651 Dual Thermal & Cold Roll Laminator

ITEM NO.
RSIRSH1651

\$17,400⁰⁰



- Wide 65" throat size
- 13' per minute cold
- 9.8' per minute hot
- 40 minute warm-up
- Accepts 1-10 mil film
- Cold pressure sensitive
- Silicone rubber hot rollers
- 2 sided encapsulation
- Mounting up to 5/8" thick

- Auto grip 2.25", 3" core size
- 9 programmable speed sets
- Standby & auto-off modes
- Reverse function & guides
- Built-in rear cross cutter
- Stand, foot control, cover
- 1 year limited warranty
- 77" x 48" x 26" / 553 lbs

RET-1652 Wide Format Electric Trimmer

ITEM NO.
RSIRET1652

\$4,700⁰⁰



- Wide 65" throat size
- 6.6'/second blade speed
- Bidirectional rotary blade
- Full length activation bar

- Open-back for long prints
- Cutting edge LED lighting
- Hands-free w/foot pedal
- Built-in safety covers

- Waste catcher for trim scraps
- Stand w/casters for mobility
- 1 year limited warranty
- 78" x 40" x 20" / 106 lbs

LARGE FORMAT LAMINATORS



CL27SD *Element Standard Roll Laminator*

ITEM NO.
DRLCL27SD

\$1,845⁰⁰



- Wide 27" throat size
- Ideal for signs & posters
- Certificates, awards, menus
- Digital LED display
- 12 minute warm-up time
- Variable temperature control

- Laminates up to 3 ft /minute
- Uses 1.5 to 3 mil film, 1" core
- 3/16" mounting capability
- Safety shield & auto-off
- 180 days part & labor warranty
- 35.5" x 18.5" x 15" / 73 lbs

DRLCL27DX **\$2,170.00**
DRLCL27PR **\$2,810.00**

CL40DX *Element Deluxe Roll Laminator*

ITEM NO.
DRLCL40DX

\$2,945⁰⁰



- Wide 40" throat size
- Large venue signage
- Digital LED display
- 12 minute warm-up time
- Variable temperature control
- Laminates up to 9 ft /minute

- 1.5 to 5 mil film, 1" or 3" core
- 3/16" mounting capability
- Built-in horizontal trimmer
- Safety shield & auto-off
- 180 days part & labor warranty
- 43" x 22" x 20" / 93 lbs

DRLCL40SD **\$2,710.00**
DRLCL40PR **\$3,120.00**

LARGE FORMAT LAMINATORS



Ultima 35[®] *EZLoad[®] Roll Laminator*

ITEM NO.
GBC1701680

\$1,199⁰⁰



- 12" throat width
- Ideal for schools, small offices
- Quick, under 2 min warm-up
- Ready LED
- Heat Shoe Accutherm tech
- Flawless, consistent results
- Motorized reverse function

- Integrated trimmer, auto-off
- One-touch AutoSpeed
- Laminates up to 36"/minute
- Uses 1.7 to 5 mil film rolls
- 1 year limited warranty
- 16.9" x 18.1" x 11.1" / 35 lbs
- EZ Load blue end cap roll film

Ultima 55[®] *EZLoad[®] Roll Laminator*

ITEM NO.
GBC1710722EZ

\$2,609⁰⁰



- Wide 27" throat width
- Ideal for posters & banners
- Less than 10 min warm-up
- Alignment guide
- Front and back stop buttons
- Slow forward & reverse function
- Integrated trimmer, auto-off

- Footage counter
- Laminates up to 120"/minute
- Uses 1.5 to 3 mil film rolls
- 90 day limited warranty
- 35" x 21" x 14" / 35 lbs
- NAP I, EZ Load roll film
- Light and dark gray end caps

Pinnacle 27[®] *EZLoad[®] Roll Laminator*

ITEM NO.
GBC1701720EZ

\$3,965⁰⁰



- Wide 27" throat size
- Ideal for busy educators
- Warms-up in 8-10 minutes
- Ready LED / 10 speed settings
- Full featured control panel
- Digital temperature readout
- Footage counter tracks use

- Built-in horizontal trimmer
- Reverse function & auto-off
- Variable, up to 12' per minute
- Uses 1.5 to 3 mil film rolls
- 1 year warranty, 14 days return
- 35.8" x 21" x 13.5" / 106 lbs
- NAP I, NAP II, EZ Load gray cap

GBC1701700 (Uses standard film) **\$4,109.00**

Ultima 65[®] *Thermal Roll Laminator*

ITEM NO.
GBC1710740

\$3,589⁰⁰



- 27" entry width
- For large, high quality projects
- Warms-up in 10 minutes
- Easy one-touch keypad
- Preset temp & speed controls
- Motorized reverse function
- Laminates 10' per minute

- Safety shield, auto shut-off
- Built-in horizontal trimmer
- Pivoting feed table
- Accepts up to 3 mil film rolls
- 90 day limited warranty
- 32.5" x 21" x 12" / 130 lbs
- Uses: NAP-Lam I film

Call Your Sales Representative Today

Canon

Reimagine the Way You Print.

Fluorescent Pink Ink

Hits 99% of the colors in the PANTONE®
FORMULA GUIDE solid coated

Intelligent Media Handling



**ImagePROGRAF
GP-4000/2000**

Printing Calculators

VENDOR / MODEL									VENDOR / MODEL								
# OF DIGITS	PRINTER TYPE (RIBBON, INK ROLLER, THERMAL)	SPEED (LPS)	2 COLOR	INDEPENDENT MEMORIES	GRAND TOTAL KEY	LEFT HANDED TOTAL	LIST PRICE		# OF DIGITS	PRINTER TYPE (RIBBON, INK ROLLER, THERMAL)	SPEED (LPS)	2 COLOR	INDEPENDENT MEMORIES	GRAND TOTAL KEY	LEFT HANDED TOTAL	LIST PRICE	
CANON									SHARP								
P1DHV-3	12	INK ROLL	2	N	3 Key	-	-	\$58.99	EL1611V	12	INK ROLL	2	Y	4 Key	Y	-	\$57.17
P23DHV-3	12	INK ROLL	2.3	Y	4 Key	-	-	\$73.99	EL1750V	12	INK ROLL	2	Y	4 Key	Y	-	\$93.43
P170DH-3	12	INK ROLL	2.3	Y	4 Key	Y	-	\$100.99	EL1801V	12	INK ROLL	2.1	Y	4 Key	Y	-	\$110.30
MP11DX-2	12	RIBBON	3.7	Y	4 Key	Y	-	\$119.99	EL2196BL	12	RIBBON	3.7	Y	4 Key	Y	Y	\$140.35
MP21DX	12	RIBBON	3.5	Y	4 Key	Y	-	\$189.99	EL1197PIII	12	RIBBON	4.3	Y	4 Key	Y	Y	\$143.15
MP25DV-3	12	RIBBON	4.3	Y	4 Key	Y	-	\$133.99	EL2630PIII	12	RIBBON	4.8	Y	4 Key	Y	Y	\$192.47
MP27DII	12	RIBBON	4.8	Y	4 Key	Y	-	\$210.99	VX2652H	12	RIBBON	4.8	Y	(2) 4 Key	Y	Y	\$236.56
MP49DII	14	RIBBON	4.8	Y	4 Key	Y	-	\$229.99	QS2760H	12	RIBBON	4.8	Y	(2) 4 Key	Y	Y	\$318.19
CP1200DII	12	RIBBON	4.3	Y	2 Key	-	-	\$299.99	QS2770H	12	RIBBON	4.8	Y	(2) 4 Key	Y	Y	\$355.54
CP1213DIII	12	RIBBON	4.8	Y	2 Key	-	-	\$329.99	VICTOR								
CASIO									1205-4	12	INK ROLL	2	N	3 Key	-	-	\$41.86
HR10RC	12	INK ROLL	1.6	N	3 Key	-	-	\$39.99	1208-2	12	INK ROLL	2.3	Y	4 Key	-	-	\$59.50
HR170RC	12	INK ROLL	2	Y	4 Key	Y	-	\$47.99	1212-3A	12	INK ROLL	2.7	Y	4 Key	Y	-	\$84.08
HR200RC	12	INK ROLL	2.4	Y	4 Key	Y	-	\$62.99	1225-3A	12	INK ROLL	3	Y	4 Key	Y	-	\$110.18
DR120R-BK	12	RIBBON	3.5	Y	4 Key	Y	-	\$81.99	1230-4	12	RIBBON	4	Y	4 Key	Y	-	\$134.74
DR210R-BK	12	RIBBON	4.4	Y	4 Key	Y	-	\$95.99	1240-3A	12	RIBBON	4.5	Y	4 Key	Y	-	\$161.86
DR270R-BK	12	RIBBON	4.8	Y	4 Key	Y	-	\$145.99	1260-3	12	RIBBON	4.6	Y	4 Key	Y	-	\$155.23
MONROE									1297	12	RIBBON	4	Y	4 Key	Y	Y	\$114.92
122PDX	12	RIBBON	4.3	Y	4 Key	-	-	\$169.00	1310	12	THERMAL	6	N	4 Key	Y	-	\$120.33
2020PLX	12	RIBBON	4.1	Y	4 Key	Y	-	\$159.00	1460-4	12	RIBBON	4.6	Y	4 Key	Y	-	\$194.23
6120X	12	RIBBON	3.6	Y	4 Key	Y	-	\$149.00	1530-6	10	RIBBON	5.2	Y	4 Key	Y	-	\$232.79
8130X	12	RIBBON	5	Y	4 Key	Y	-	\$259.00	1560-6	12	RIBBON	5.2	Y	4 Key	Y	-	\$257.07
8145X	14	RIBBON	5	Y	(2) 4 Key	Y	-	\$329.00	1570-6	14	RIBBON	5.2	Y	4 Key	Y	-	\$286.86
ULTIMATEXB	12	RIBBON	5	Y	(2) 4 Key	Y	-	\$324.00	2640-2	12	RIBBON	4.6	Y	4 Key	Y	Y	\$155.23
									PL8000	14	THERMAL	8	N	4 Key	Y	-	\$155.23

This information has been gathered from manufacturers' representatives and manufacturers' specification sheets and we have endeavored to be as accurate as possible. We apologize in advance for any errors or inaccurate information.

Call Your Sales Representative Today

Paper Rolls

ITEM CODE	ROLL W x L	CORE	DESCRIPTION	PACK	LIST
Bond Paper Rolls					
PRNNB5170	1.75" x 170'	7/16 "	1-Ply, 44mm	box/100	\$89.00
PRN9074-2235	2.25" x 150'	7/16 "	1-Ply, 57mm	box/100	\$77.95
PRN9074-2236	2.75" x 150'	7/16 "	1-Ply, 70mm	box/50	\$49.65
PRN9074-2238	3" x 150'	7/16 "	1-Ply, 76mm	box/50	\$52.38
PRN9074-2239	3" x 165'	7/16 "	1-Ply, 76mm	box/50	\$64.54
PRN9074-2240	3" x 190'	7/16 "	1-Ply, 76mm	box/50	\$72.63
Carbonless Bond Rolls					
PRN9077-0438	2.25" x 90'	7/16 "	2-Ply, white & canary	box/50	\$59.35
PRNN7100C	2.25" x 100'	7/16 "	2-Ply, white & canary	box/100	\$137.75
PRN9077-0047	3" x 90'	7/16 "	2-Ply, white & canary	box/50	\$84.78
PRN9077-0012	3" x 100'	7/16 "	2-Ply, white & canary	box/50	\$92.90
PRN9077-0439	3.25" x 90'	7/16 "	2-Ply, white & canary	box/50	\$90.46
PRN9077-0060	3" x 70'	7/16 "	3-Ply, white, canary & pink	box/50	\$98.40
Thermal Paper Rolls					
PRN9078-2980	1.75" x 220'	7/16 "	1-Ply thermal. 44mm	box/50	\$89.95
PRN9078-0567	2.25" x 50'	7/16 "	1-Ply thermal, 57mm	box/50	\$38.00
PRN9078-0076	2.25" x 85'	7/16 "	1-Ply thermal, 57mm	pk/3	\$4.96
PRN9078-0549	2.25" x 85'	7/16 "	1-Ply thermal, 57mm	box/50	\$43.00
PRN9078-0568	2.25" x 150'	7/16 "	1-Ply thermal, 57mm	box/50	\$87.15
PRN9078-2983	2.25" x 230'	7/16 "	1-Ply thermal, 57mm	box/50	\$122.90
PRN9078-3044	3.125" x 119'	7/16 "	1-Ply thermal. 80mm	box/50	\$85.65
PRN9078-5087	3.125" x 200'	7/16 "	1-Ply thermal. 80mm	box/50	\$122.25
PRN9078-0668	3.125" x 220'	7/16 "	1-Ply thermal. 80mm	box/50	\$129.55
PRN9078-0565	3.125" x 230'	7/16 "	1-Ply thermal. 80mm	box/50	\$117.85
PRN9078-0566	3.125" x 273'	7/16 "	1-Ply thermal. 80mm	box/50	\$140.88



3400 Pocket Real Estate Master

ITEM NO.
CAL3400

\$29⁹⁵



- 9 digit display
- Battery powered (2) LR43
- Solve real estate problems
- Simple financial solutions
- Payment, loan, interest, term

- Amortization, date-math
- Silver w/hard cover door
- 1 year limited warranty
- 2.9" x 0.4" x 4.8" / 3 oz

3405 Real Estate Master IIIIX

ITEM NO.
CAL3405

\$44⁹⁵



- 9 digit segment display
- Battery powered (2) LR44
- Complete payment solutions
- Amortization, combo loans
- Rent vs. buy comparisons

- Future value, appreciation
- Silver with slide cover
- 1 year limited warranty
- 3" x 0.6" x 5.8" / 3 oz

CAL5022-2 (Hard Case) **\$14.95**

43430 Qualifier Plus IIIIFX Desktop

ITEM NO.
CAL43430

\$64⁹⁵



- 9 digit tilt display
- Battery powered (CR2032)
- Perfect for investors or lenders
- Real estate, mortgage answers
- Pre-qualify, financial solutions
- Cash flow, IRR, NPV, NFV, PITI

- Amortization, combo loans
- Rent vs. buy, tax savings
- Silver
- 1 year limited warranty
- 6.4" x 9" x 1.4" / 11 oz

6025 Scale Master Pro

ITEM NO.
CAL6025

\$74⁹⁵



- Dual LCD with full annunciators
- Battery powered (2) CR2430
- Linear, area, volume take-offs
- 72 built-in architectural scales
- 6 custom scales for drawings
- L, W, H, count, subtract keys

- Accumulating memory
- U.S. and Metric conversions
- Lock switch, auto shut-off
- Black with custom pouch
- 1 year limited warranty
- 1.9" x 0.6" x 7.3" / 2 oz

CAL6135 **\$109.95**

6410 Wheel Master 4S

ITEM NO.
CAL6410

\$39⁹⁵



- 6 digit magnified counter
- Measures up to 9,999 feet
- Telescoping 3-piece handle
- Extends to 42" and snap locks
- Collapses to 20" for carrying
- Ideal for landscaping, flooring

- Decorators, real estate pros
- Painters, Do-It-Yourselfers
- 4" single wheel / 1.3 lbs
- Reflective tape for safety
- 2 year limited warranty

CAL5010-12 (Carry Case) **\$24.95**

6435 Wheel Master 4D

ITEM NO.
CAL6435

\$54⁹⁵



- Easy-to-read magnified display
- Measures up to 9,999 feet
- Telescoping 3-piece handle
- Extends to 42" and snap locks
- Collapses to 20" for carrying
- Ideal for landscaping, flooring

- Real estate, insurance agents
- Appraisers, surveyors, painters
- 4" balanced dual wheels
- Reflective tape for safety
- 2 year limited warranty

CAL5010-12 (Carry Case) **\$24.95**

6530 Wheel Master Classic 12

ITEM NO.
CAL6530

\$74⁹⁵



- 6 digit magnified display
- Measures up to 9,999 feet
- Ergonomic comfort pistol grip
- EZ fold system hinged handle
- Half size 41" to 22" for storage
- Ideal for appraisers, surveyors
- Contractors, engineers, utility

- Fencing, flooring, police work
- 12.5" heavy-duty wheel
- Sturdy flip-down kickstand
- Reflective tape for safety
- 2 year limited warranty

CAL5010-12 (Carry Case) **\$24.95**

6540 Wheel Master Pro 12

ITEM NO.
CAL6540

\$109⁹⁵



- Professional commercial grade
- 6 digit display, up to 9,999 feet
- Balanced center-line design
- Comfort pistol grip w/hand brake
- Sealed, gear-driven transmission
- EZ fold system hinged handle
- Half size 38" to 19" for storage

- Reset counter w/thumb or foot
- 12.5" heavy-duty wheel
- Sturdy flip-down kickstand
- Reflective tape for safety
- 2 year limited warranty

CAL5010-12 (Carry Case) **\$24.95**

Call Your Sales Representative Today

6575 *Wheel Master Plus III*

ITEM NO.
CAL6575

\$199⁹⁵



- Professional commercial grade
- 7 digit display, up to 99,999 ft
- Balanced center-line design
- Comfort pistol grip w/hand brake
- Sealed, gear-driven transmission
- EZ fold system hinged handle

- Half size 41" to 22" for storage
- Reset counter w/thumb or foot
- 12.5" heavy-duty wheel
- Sturdy flip-down kickstand
- Reflective tape for safety
- 2 year limited warranty

4065 *Construction Master Pro*

ITEM NO.
CAL4065

\$74⁹⁵



- 11 digit display
- Battery powered (2) LR44
- Advanced estimate solutions
- Complete layouts, plans, bids
- Convert building dimensions
- Pitch, framing, floor thickness
- Circular, arc, stair, riser, treads

- Linear, area, volume, weight
- Silver w/Armadillo case
- 1 year limited warranty
- 3" x 0.6" x 5.6" / 4.5 oz

CAL5022-2 (Hard Case)..... **\$14.95**

4080 *Construction Master Pro Trig*

ITEM NO.
CAL4080

\$89⁹⁵



- 11 digit display
- Battery powered (2) LR44
- Solve complex designs
- Full trigonometric functions
- Convert building dimensions
- Inverse angle, circular, sine
- Run, rise, pitch, jacks, arcs

- Roof, rafter, framing, stairs
- Linear, area, volume, weight
- Silver w/Armadillo case
- 1 year limited warranty
- 3" x 0.6" x 5.6" / 4.5 oz

CAL5022-2 (Hard Case)..... **\$14.95**
CAL44080 (Desktop Version)..... **\$89.95**

4088 *Machinist Calc Pro 2*

ITEM NO.
CAL4088

\$99⁹⁵



- 12 digit 2-line display
- Battery powered (CR2025)
- Specific keys for DOC & WOC
- 20 materials, 6 process, 3 tools
- Speeds/feeds, face, end & slot
- Milling, turning, drilling, boring

- Bolt patterns, 3-wire measures
- Built-in drill, thread/tap tables
- Dark gray w/Armadillo case
- 1 year limited warranty
- 3.5" x 0.9" x 6" / 7 oz

4020 *Measure Master Pro*

ITEM NO.
CAL4020

\$44⁹⁵



- 11 digit display
- Battery powered (2) LR44
- Convert between dimensions
- Feet-inch-fraction, yard, metric
- Circumference, circle area, arc

- Linear, area, volume, weight
- Silver w/hard slide cover
- 1 year limited warranty
- 3" x 0.6" x 5.6" / 4.5 oz

CAL5022-2 (Hard Case)..... **\$14.95**

4325 *HeavyCalc Pro*

ITEM NO.
CAL4325

\$74⁹⁵



- 11 digit display
- Battery powered (CR2032)
- Dimensional math/conversions
- Equipment/man-power planning
- Yard, feet-inch-fraction, metric
- Auto areas, volumes, loads
- Square-ups, angles, cut/fill

- Weight, slopes, swell, shrink
- Dark gray w/hard cover
- 1 year limited warranty
- 3" x 0.7" x 5.7" / 3 oz

8025 *Ultra Measure Master*

ITEM NO.
CAL8025

\$44⁹⁵



- 11 digit segment display
- Battery powered (CR2016)
- 400+ conversion combinations
- 60 built-in U.S. and metric units
- Liquid, dry and temperature
- Linear, area, weight, volume

- Velocity, flow rates, pressure
- Silver w/hard slide cover
- 1 year limited warranty
- 3" x 0.7" x 5.7" / 4 oz

5070 *ElectriCalc Pro*

ITEM NO.
CAL5070

\$99⁹⁵



- 8 digit segment display
- Battery powered (CR2016)
- Code based electrical answers
- Calculates fuse/breaker sizes
- Full-load amps, voltage drops
- Sizing for 12 types of conduit
- Grounding conductor sizes

- Kilowatt/BTU conversions
- Wire size NEC tables shown
- Updatable code revision w/kit
- Yellow w/Armadillo flip-top
- 1 year limited warranty
- 3" x 0.6" x 5.6" / 4.5 oz

LS-82Z *Handheld Calculator*

ITEM NO.
CNM4075A007

\$13⁹⁹



- 8 digit angled display
- Dual powered
- 3 key independent memory
- Percent, square root keys
- Floating decimal system
- Auto power-off
- White/gray
- 1 year limited warranty
- 3.5" x 4.4" x 1.3" / 2 oz

LS-270G *Handheld Green Calculator*

ITEM NO.
CNM4640B001

\$12⁹⁹



- 8 digit large display
- Dual powered
- 3 key independent memory
- Made of 50% recycled plastic
- Percent, square root keys
- Markup, sign change
- Auto power-off
- Champagne
- 1 year limited warranty
- 2.4" x 0.4" x 4" / 2 oz

LS-88Hi III *Mini-Desktop Calculator*

ITEM NO.
CNM4425B008

\$15⁹⁹



- 8 digit extra large display
- Angled upright LCD design
- Dual powered w/auto-off
- 3 key independent memory
- Percent, square root keys
- Sign change feature
- 1 year limited warranty
- 5.6" x 5.4" x 1" / 3.2 oz

LS-100TS *Desktop Business Calculator*

ITEM NO.
CNM5936A028

\$16⁹⁹



- 10 digit angled display
- Dual powered w/auto-off
- 3 key independent memory
- Percent, square root keys
- Cost-sell-margin, backspace
- Sign change, tax keys
- Metallic silver
- 1 year limited warranty
- 4.1" x 5.3" x 1.3" / 4 oz

LS-154TG *Handheld Green Calculator*

ITEM NO.
CNM1075B004

\$19⁹⁹



- 12 digit display
- Dual powered (CR2016)
- 3 key independent memory
- Made of 49% recycled plastic
- Percent, square root keys
- Rate set/recall, tax +/-
- Sign change, auto power-off
- Rotating protective lid
- 1 year limited warranty
- 3" x 0.5" x 4.8" / 3 oz

HS-1200TS *Desktop Calculator*

ITEM NO.
CNM7438A023

\$22⁹⁹



- 12 digit angled display
- Dual powered w/auto-off
- 3 key independent memory
- Percent, square root keys
- Cost-sell-margin, backspace
- Rate set/recall, tax +/- keys
- Decimal select, rounding
- Sign change, grand total
- Metallic silver
- 1 year limited warranty
- 4.8" x 6.7" x 1.4" / 6 oz

LS-555H *Handheld Calculator*

ITEM NO.
CNM4009A006

\$22⁹⁹



- 8 digit large display
- Dual powered
- 4 key independent memory
- Percent, square root keys
- Sign change
- Auto power-off
- Compact fold over design
- 1 year limited warranty
- 4.3" x 2.7" x 0.6" / 3 oz

Call Your Sales Representative Today

F-605 Scientific Calculator

ITEM NO.
CNM9832B001

\$16⁹⁹

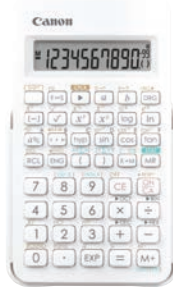

- 10 + 2 digit display
- Battery powered (LR44)
- 154 scientific functions
- Statistics and trigonometry
- Complex numbers, base-N
- Exponentials, hyperbolic
- Octal binary hexadecimal

- Factorials, logarithmic
- Grand total memory
- White w/removable cover
- 1 year limited warranty
- 3" x 0.7" x 5.9" / 3 oz

TX-220TSII Desktop Calculator

ITEM NO.
CNM0633C001

\$29⁹⁹



- 12 digit tilttable display
- Dual powered w/auto off
- 3 key independent memory
- Percent, square root keys
- Cost-sell-margin, sign change
- Rate set/recall, tax +/-

- Decimal select, rounding
- Grand total, backspace
- White
- 1 year limited warranty
- 5.7" x 5.7" x 1" / 6 oz

F-719SG Scientific Green Calculator

ITEM NO.
CNM4178B001

\$29⁹⁹

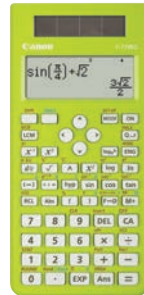

- 31 x 96 dots natural display
- Dual powered w/auto-off
- 302 functions, 38 formulas
- Made of 86% recycled plastic
- Trigonometry, hyperbolics
- Exponentials, deviations

- Logarithms, reciprocals
- Factorials, conversions
- Store/recall/answer memories
- 1 year limited warranty
- 3.2" x 0.6" x 6.3" / 4.5 oz

TS-1200TSC Desktop Green Calculator

ITEM NO.
CNM2468C001

\$30⁹⁰



- 12 digit tilttable display
- Dual powered w/auto-off
- 3 key independent memory
- Percent, sign change
- Cost-sell-margin, backspace
- Rate set/recall, tax +/- keys

- Decimal select, rounding
- Currency conversion
- Metallic faceplate
- 1 year limited warranty
- 5" x 7" x .07" / 7 oz

F-792SGA Scientific Green Calculator

ITEM NO.
CNM6608B001

\$30⁹⁹

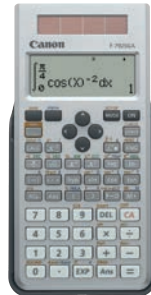

- 31 x 96 dots natural display
- Dual powered w/auto-off
- 648 functions, 38 formulas
- LCM, GCD, random integers
- Probability distribution, Trig
- Quotient & remainder, square
- Exponential, logarithm, roots

- Hyperbolic, Mean, notations
- Factorial, complex numbers
- Store/recall/answer memories
- 1 year limited warranty
- 3.9" x 0.5" x 5.2" / 4.2 oz

WS-1400H Portable Desktop Calculator

ITEM NO.
CNM4087A005

\$42⁹⁹



- 14 digit tilttable display
- Dual powered (LR1130)
- 3 key independent memory
- Percent, square root keys
- Markup, sign change
- Decimal select, rounding

- Grand total, backspace
- Auto power-off
- Black
- 1 year limited warranty
- 6" x 8" x 1" / 8.6 oz

BS-1200TS Desktop Calculator

ITEM NO.
CNM8507A010

\$58⁹⁹

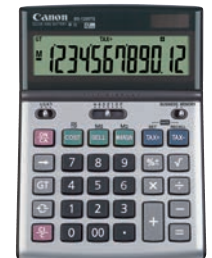

- 12 digit tilttable display
- Dual powered w/auto-off
- 3 key independent memory
- Percent, square root keys

- Cost-sell-margin, backspace
- Rate set/recall, tax +/- keys
- Decimal select, rounding
- Sign change, grand total

- Metallic silver
- 1 year limited warranty
- 5.1" x 7.2" x 1.1" / 8.4 oz

P1DHV-3 *Portable Palm Printing Calculator*

ITEM NO.
CNM2203C001

\$58⁹⁹



- 12 digit display
- Black ink roll printer/ 2.0 lps
- 3 key independent memory
- Cost-sell-margin, sign change

- Percent, tax calculation
- Decimal select, rounding
- Double check, time calcs
- Auto power-off

- (4) AA batteries included
- 1 year limited warranty
- 4" x 8" x 1.9" / 9 oz
- PORPR40 roller, ZB2150 paper

P23DHV-3 *Desktop Printing Calculator*

ITEM NO.
CNM2279C001

\$73⁹⁹



- 12 digit large display
- 2 color ink roll printer/ 2.3 lps
- 4 key independent memory
- Cost-sell-margin, sign change
- Percent, tax calculation
- Decimal select, rounding

- Calendar/clock, item count
- 1 year limited warranty
- 6.4" x 8.5" x 2" / 1 lb
- CIMIR40T roller, ZB2150 paper

P170-DH-3 *Desktop Printing Calculator*

ITEM NO.
CNM2204C001

\$100⁹⁹



- 12 digit display
- 2 color ink roller/ 2.3 lps
- 4 key independent memory
- Percent, backspace, tax +/-
- Cost-sell-margin, sign change
- Decimal select, rounding

- Double check, grand total
- Calendar/clock function
- Time calculation
- 1 year limited warranty
- 7.4" x 10.5" x 2.4" / 2 lbs
- PORPR42 roller, ZB2150 paper

MP11DX-2 *Desktop Printing Calculator*

ITEM NO.
CNM2198C001

\$119⁹⁹



- 12 digit display
- 2 color ribbon printer/ 3.7 lps
- 4 key independent memory
- Percent, backspace, tax +/-
- Cost-sell-margin, sign change
- Decimal select, rounding
- Double check, grand total

- Calendar/clock function
- Brushed nickel
- 1 year limited warranty
- 8.9" x 13" x 2.9" / 4 lbs
- GRCE201 ribbon, ZB2150 paper

MP21DX *Desktop Printing Calculator*

ITEM NO.
CNM2292B001

\$189⁹⁹



- 12 digit display
- 2 color ribbon printer/ 3.5 lps
- 4 key independent memory
- Delta percent, backspace, tax +/-
- Markup/down, sign change
- Decimal select, rounding

- Item count, grand total
- Soft white
- 1 year limited warranty
- 9" x 12" x 2.9" / 4 lbs
- GRCE201 ribbon, ZB2150 paper

MP25DV-3 *Desktop Printing Calculator*

ITEM NO.
CNM2202C001

\$133⁹⁹



- 12 digit display
- 2 color ribbon printer/ 4.3 lps
- 4 key independent memory
- Percent, backspace, tax +/-
- Cost-sell-margin, sign change
- Decimal select, rounding

- Double check, grand total
- Calendar/clock function
- Brushed nickel
- 1 year limited warranty
- 8.2" x 12.0" x 3.1" / 3.3 lbs
- GRCE201 ribbon, ZB2150 paper

MP27DII *Desktop Printing Calculator*

ITEM NO.
CNM8707B001

\$210⁹⁹



- 12 digit display
- 2 color ribbon printer/ 4.8 lps
- 4 key independent memory
- Percent, backspace, tax +/-
- Cost-sell-margin, sign change
- Decimal select, rounding
- Item count, grand total

- Calendar/clock function
- Soft white
- 1 year limited warranty
- 8.9" x 13" x 3" / 4 lbs
- GRCE201 ribbon, ZB2150 paper

MP49DII *Desktop Printing Calculator*

ITEM NO.
CNM8708B001

\$229⁹⁹



- 14 digit large display
- 2 color ribbon printer/ 4.8 lps
- 4 key independent memory
- Percent, backspace, tax +/-

- Cost-sell-margin, sign change
- Item count, grand total
- Calendar/clock function
- Currency conversions

- Soft white
- 1 year limited warranty
- 8.9" x 13" x 3" / 4 lbs
- GRCE201 ribbon, ZB2150 paper

CP1200DIII *Commercial Printing Calculator*

ITEM NO.
CNM9932B001

\$299⁹⁹



- 12 digit ex-large display
- 2 color ribbon printer/ 4.8 lps
- 2 key independent memory
- Average, pairing calculations
- Decimal select, rounding
- Markup, item count

- Recall item function
- 1 year limited warranty
- 9.5" x 13.4" x 3.4" / 4 lbs
- GRCE201 ribbon, ZB2150 paper

CP1213DIII *Commercial Printing Calculator*

ITEM NO.
CNM9933B001

\$329⁹⁹



- 12 digit ex-large display
- 2 color ribbon printer/ 4.8 lps
- 2 key independent memory
- Average, pairing calculations
- Decimal select, rounding
- Markup, item count

- Recall item function
- 1 year limited warranty
- 9.5" x 13.4" x 3.4" / 4 lbs
- GRCE201 ribbon, ZB2150 paper

About Canon's Calculators

Merging convenience and efficiency right at your fingertips, Canon calculators have stylish designs with a variety of models so you can find results for every task. Canon calculators are known as some of the best calculators for handheld, desktop, office printing, and scientific calculators. With our wide range of sleek models, you will find the features and functions you need for school, business, or everyday calculations. Canon Premium calculators combine a fashionable design as well as impressive features in a slim, high-end desktop calculator. With a large LCD screen, memory keys, and solar power source these calculators are portable and multifunctional perfect for everyday use. This supports sustainability and offers the perfect balance of maximum style and minimum waste. Canon's Green calculators are made from 100% recycled plastic and are compact in design and feature a dual power supply for all your calculation needs.

Canon Printing Calculators incorporate a fast and durable printing unit for clear printouts in one or two colors. Their ergonomic keyboards and large displays add to their convenience and make them perfect for heavy-duty use in busy offices. Their fast print speeds ensure productive performance. Whether you're calculating your taxes, currency exchanges, or business functions we have printing calculators that are portable or the perfect fit for your desk. If you're a student and need of a compact calculator with powerful performance with 38 built-in formulas, Canon scientific calculators are perfect for your education. With a slim and lightweight design, they offer students a simple solution to complex problems.

Canon calculators are known for high accuracy and ease of use. With some of the top reviews, Canon calculators are the best quality for everyday use whether you're a professional or student. With lightweight designs and easy use, Canon calculators have the variety to give you some of the best performance you need.

HS-8VA Handheld Calculator

ITEM NO.
CSOHS8VA

\$5⁹⁹



- 8 digit large, clear display
- Dual powered (LR1130)
- 3 key independent memory
- Percent, square root keys
- Sign change, auto constants
- Markup, auto power-off
- Silver, dark grey keys
- 1 year limited warranty
- 2.3" x 0.3" x 4" / 5 oz

HS-4G Handheld Calculator

ITEM NO.
CSOHS4G

\$6⁹⁹



- 8 digit display
- Super solar powered
- 4 key independent memory
- Percent, square root keys
- Sign change, auto constants
- Auto power-off
- White, light grey keys
- 1 year limited warranty
- 2.2" x 0.3" x 3.4" / 4 oz

SL-300SV Handheld Calculator

ITEM NO.
CSOSL300SV

\$10⁹⁹

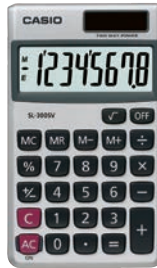

- 8 digit large, clear display
- Dual powered (LR1130)
- 4 key independent memory
- Percent, square root keys
- Sign change, auto constants
- Auto power-off
- Silver, black keys
- 1 year limited warranty
- 2.8" x 0.3" x 4.6" / 6 oz

SL-310SV Handheld Calculator

ITEM NO.
CSOSL310SV

\$12⁹⁹

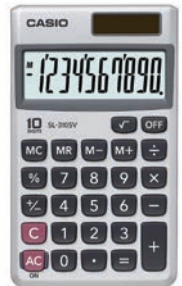

- Extra large 10 digit display
- Ultra thin, compact design
- Dual powered (LR1130)
- 4 key independent memory
- Percent, square root keys
- Sign change, auto power-off
- Durable metal face
- Wallet type case included
- 4.75" x 0.8" x 6.75" / 7 oz

MS-80B Desktop Calculator

ITEM NO.
CSOMS80B

\$14⁹⁹



- 8 digit large, angled display
- Solar Plus w/battery backup
- 3 key independent memory
- Percent, constants, tax +/-
- Sign change, auto power-off
- Currency exchange
- Silver-metallic finish
- 1 year limited warranty
- 4" x 5.4" x 1.3" / 4 oz

MH-10M Business Calculator

ITEM NO.
CSOMH10M

\$20⁹⁹



- 10 digit large display
- Solar Plus w/battery backup
- 3 key independent memory
- Percent, backspace, tax +/-
- Cost-sell-margin, sign change
- White, black
- 1 year limited warranty
- 6.5" x 7.25" x 1" / 7 oz

JF-100BM Semi-desktop Calculator

ITEM NO.
CSOJF100BM

\$22⁹⁹



- 10 digit large display
- Solar Plus w/battery backup
- 3 key independent memory
- Percent, backspace, rate, tax +/-
- Cost-sell-margin, sign change
- Decimal select, rounding
- Grand total, auto power-off
- Metallic silver
- 1 year limited warranty
- 4" x 7" x 0.9" / 5.5 oz

DV-220 Desktop Calculator

ITEM NO.
CSODV220

\$26⁹⁹



- Dual displays, 12 digits each
- 2 calculators in one
- Dual powered, grand total
- Percent, backspace keys
- Cost-sell-margin, sign change
- Double zero, tax rate +/-
- Decimal select, rounding
- Currency conversions
- White, black
- 1 year limited warranty
- 5.3" x 7.4" x 1.4" / 9 oz

Call Your Sales Representative Today

DJ-120D Desktop Calculator

ITEM NO.
CSODJ120D

\$24⁹⁹



- Easily review last 150 entries
- Make corrections/recalculates
- 12 digit extra-large display
- Dual powered (LR44)
- 3 key independent memory
- Percent, square root, markup

- Decimal select, rounding
- Sign change, grand total
- Charcoal, black
- 1 year limited warranty
- 5.5" x 7.5" x 1.5" / 7 oz

DM-1200BM Desktop Calculator

ITEM NO.
CSODM1200BM

\$27⁹⁹



- 12 digit angled big display
- Solar Plus w/battery backup
- 4 key independent memory
- Percent, backspace, tax +/-
- Cost-sell-margin, sign change
- Decimal select, rounding

- Grand total, auto power-off
- Metallic silver
- 1 year limited warranty
- 6" x 8" x 1.5" / 10 oz

HR10RC Portable Desktop Printing Calculator

ITEM NO.
CSOHR10RC

\$39⁹⁹



- 12 digit large display
- Black ink roll printer/ 1.6 lps
- 3 key independent memory
- Cost-sell-margin, Percent
- Currency exchange
- Decimal select, tax +/-
- Check & correct

- Reprint / after print
- Optional battery operation
- 1 year limited warranty
- 4" x 7.6" x 1.6" / 12 oz
- CIMIR40 roller, ZB2165 paper

HR170RC Desktop Printing Calculator

ITEM NO.
CSOHR170RC

\$47⁹⁹



- 12 digit big display
- 2 color ink roll printer/ 2.0 lps
- 4 key independent memory
- Percent, backspace, tax +/-
- Cost-sell-margin, sign change
- Decimal select, rounding
- Reprint / after print

- Check & correct 150 entries
- Calendar/clock function
- Optional battery operation
- 1 year limited warranty
- 6.5" x 8.6" x 2.6" / 1 lb
- CIMIR40T roller, ZB2165 paper

HR200RC Desktop Printing Calculator

ITEM NO.
CSOHR200RC

\$62⁹⁹



- 12 digit big display
- 2 color ink roll printer/ 2.4 lps
- 4 key independent memory
- Percent, backspace, tax +/-
- Cost-sell-margin, sign change
- Decimal select, rounding
- Reprint / after print

- Check & correct 150 entries
- Calendar/clock function
- Optional battery operation
- 1 year limited warranty
- 7.7" x 10.8" x 2.6" / 1.5 lbs
- CIMIR40T roller, ZB2165 paper

DR120R-BK Desktop Printing Calculator

ITEM NO.
CSODR120R-BK

\$81⁹⁹



- 12 digit large display
- 2 color ribbon printer/ 3.5 lps
- 4 key independent memory
- Percent, backspace, tax +/-
- Cost-sell-margin, sign change
- Markup/down, change key

- Reprint / after print
- Item count, grand total
- Change key
- 1 year limited warranty
- 8.3" x 15" x 4.4" / 3.1 lbs
- GRCE201 ribbon, ZB2165 paper

DR210R-BK Heavy Duty Printing Calculator

ITEM NO.
CSODR210R-BK

\$95⁹⁹



- 12 digit large display
- 2 color ribbon printer/ 4.4 lps
- 4 key independent memory
- Percent, backspace, tax +/-
- Cost-sell-margin, sign change
- Markup/down, change key

- Reprint / after print
- Item count, grand total
- Calendar/clock function
- 1 year limited warranty
- 8.1" x 15" x 4.4" / 3.3 lbs
- GRCE201 ribbon, ZB2165 paper

DR270R-BK Heavy Duty Printing Calculator

ITEM NO.
CSODR270R-BK

\$145⁹⁹



- 12 digit extra-large display
- 2 color ribbon printer/ 4.8 lps
- 4 key independent memory
- Percent, backspace, tax +/-
- Cost-sell-margin, sign change
- Markup/down, change key

- Reprint / after print
- Item count, grand total
- Calendar/clock function
- 1 year limited warranty
- 8.1" x 15" x 4.4" / 3.3 lbs
- GRCE201 ribbon, ZB2165 paper

FX-260SOLARII Scientific Calculator

ITEM NO.
CSOFX260SOLARII

\$15⁹⁵



- 10+2 digit display
- Solar powered w/auto-off
- 144 built-in science functions
- Statistics, algebra, trigonometry
- Parentheses, sign change, shift
- Fraction form/conversions
- Exponentials, hyperbolics
- Deviations, store/recall
- Slide-on hard case
- White/Black
- 1 year limited warranty
- 3" x 0.3" x 5" / 3 oz

FX-300MS PlusII 2nd Edition Scientific Calculator

*Teacher Kit Available
**Emulator Software Available

ITEM NO.
CSOFX300MSPLUS2

\$19⁹⁹



- For middle thru high school
- 2 line x12 digit display
- Solar Plus w/battery backup
- Fraction, decimal conversions
- Algebra I and II, general math
- Trig, statistics, biology, finance
- Logarithms, exponents, powers
- Permutations and combinations
- Inverse/hyperbolic functions
- 10 memories, multi-replay
- Black, case included
- 1 year limited warranty
- 3.6" x 0.83" x 7.25" / 4 oz

FX-55 Plus Fraction Calculator

*Teacher Kit Available
**Emulator Software Available

ITEM NO.
CSOFX55PLUS

\$22⁹⁵



- 10+2 true fraction display
- Dual powered
- True algebraic logic
- Ideal for middle grade math
- Square/cube root, exponents
- Random numbers, Pi, shift
- Fraction form/conversions
- Division with remainder
- Blue w/color coded keys
- 1 year limited warranty
- 3" x 0.4" x 5.6" / 3 oz

FX-115ES PlusII 2nd Edition Scientific Calculator

**Emulator Software Available

ITEM NO.
CSOFX115ESPLS2-S

\$30⁹⁵



- Highschool or college companion
- Natural V.P.A.M.; textbook display
- Solar Plus w/battery backup
- 417 built-in science functions
- Algebra I and II, general math
- Trigonometry, statistics, geometry
- Engineering, calculus, chemistry
- Exponentials, hyperbolics
- Deviations, regressions
- Store, recall, edit values
- White, case included
- 1 year limited warranty
- 3" x 0.6" x 6.25" / 4 oz

FX-991EX Advanced Scientific Calculator

**Emulator Software Available

ITEM NO.
CSOFX991EX

\$34⁹⁵



- 15 natural textbook display
- Solar Plus w/battery backup
- 47 constants, 40 conversions
- Trigonometry, algebra, fractions
- Engineering, complex numbers
- Computer science, statistics
- Exponentials, hyperbolics
- Deviations, regressions
- 9 memory variables
- 1 year limited warranty
- 3" x 0.4" x 6.5" / 4 oz

FX-9750GIII 3rd Edition Graphic Calculator

**Emulator Software Available

ITEM NO.
CSOFX9750GIII

\$91⁹⁵



- 21 digit x 8 line icon display
- Interactive equation solver
- Complex numbers, matrix
- Generate plots and graphs
- Capture, clip & paste capable
- Inverse/hyperbolic functions
- Deviations, regressions
- Prior entry recall
- Black, slide on hard case
- 64 KB, USB connectivity
- 4 AAA batteries included
- 1 year limited warranty
- 3.6" x 0.83" x 7.25" / 4 oz

FX-CG50 PRIZIM™ Color Graphing Calculator

**Emulator Software Available

ITEM NO.
CSOFXCG50

\$136⁹⁵



- 3.17" Color LCD display
- 3D graph drawings
- Natural textbook illustrations
- Real-life Picture Plot feature
- Graph, conics, geometry modes
- Finance, statistics, equations
- Color link graph/data function
- AP, SAT/II, PSAT/NMSQT, ACT
- USB to computer connectivity
- 1 year limited warranty
- 3.5" x 7.5" x 0.8" / 8 oz

***Teacher Kit Includes: 10 Calculators, Workbook, Large Calculator Poster & Storage Box**

****Emulator Software Available: Please call for more information**

Things the other guys don't want to hear...



Superior Quality. Increased Profitability. Guaranteed.

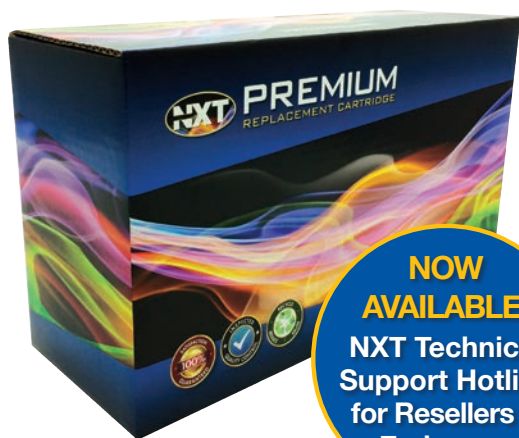

**NOW
AVAILABLE!**
NXT Technical
Support Hotline
for Resellers &
End-users

NXT Premium is the NeXT Best Thing in Toner

Others keep telling you that buying and selling their recycled toner is to your advantage, but NXT Premium Replacement Cartridges are quality-tested, performance certified cartridges that offer a Lifetime Warranty.

- 100% lifetime warranty
- Certified performance (ISO/STMC)
- Reduce printing costs up to 50%
- High quality new components
- Expanded U.S. distribution

www.NXTpremium.com

MW01 Calculator Wedge Stand

ITEM NO.
MNEMW01

\$15⁰⁰

**Calculator Not Included*



- Angled foam machine pad
- Changes view, reduces glare
- Reduces printer noise

- Protects desktop surface
- 8" x 10" x 2"

MNEMW02 (Large, 9" x 15" x 3").....**\$20.00**

6120X Desktop Printing Calculator

ITEM NO.
MNE6120X

\$149⁰⁰



- 12 digit display
- 2 color ribbon printer/ 3.6 lps
- 4 key independent memory
- Percent, backspace, tax +/-
- Cost-sell-margin, sign change
- Item count, date/non-add
- Decimal select, rounding

- Ivory
- Markup, group/grand total
- 6 month limited warranty
- 8.5" x 11" x 2.8" / 4 lbs
- Uses: MNEAR12225 paper
- MNEM33X ribbon

MNE6120XB (Black).....**\$149.00**

2020 Plus X Desktop Printing Calculator

ITEM NO.
MNE2020PLXB

\$159⁰⁰



- 12 digit display
- 2 color ribbon printer/ 4.1 lps
- 4 key independent memory
- Percent, backspace, tax +/-
- Sign change, auto constants
- Item count, date/non-add
- Decimal select, rounding

- Black
- Markup, group/grand total
- 6 month limited warranty
- 8" x 11" x 2.8" / 4 lbs
- Uses: MNEAR12225 paper
- MNEM33X ribbon

MNE2020PLX (Ivory).....**\$159.00**

ULTIMATEX Heavy Duty Desktop Printing Calculator

ITEM NO.
MNEULTIMATEXB

\$324⁰⁰



- 12 digit display
- 2 color ribbon printer/ 5 lps
- (2) 4 key independent memories
- Individual keyswitch technology
- Cost-sell-margin, 5 tax rates
- Item count, grand total
- Conversions, time clock

- Averaging, crossfooting
- Edit up to 99 entries
- 6 month limited warranty
- 9.5" x 15" x 3.7" / 5 lbs
- Uses: MMNEAR12225 paper
- MNEM33X ribbon

12DHC Handheld Calculator

ITEM NO.
MNE12DHC

\$27⁹⁹



- 12 digit tilttable display
- Dual solar/battery powered
- 3 key independent memory
- Check & correct 150 entries
- Percent, square root keys
- Sign change, backspace

- Decimal select and rounding
- Markup, grand total
- Silver/blue
- 6 month limited warranty
- 6.5" x 4.25" x .5" / 5.6 oz

122PDX Desktop Printing Calculator

ITEM NO.
MNE122PDX

\$169⁰⁰



- 12 digit display
- 2 color ribbon printer/ 4.3 lps
- 4 key independent memory
- Percent, markup, backspace
- Sign change, auto constants
- Item count, date/non-add

- Ivory
- Decimal select, rounding
- 6 month limited warranty
- 8" x 11" x 2.8" / 4.5 lbs
- Uses: MNEAR12225 paper
- MNEM33X ribbon

8130X Heavy Duty Desktop Printing Calculator

ITEM NO.
MNE8130XB

\$259⁰⁰



- 12 digit display
- 2 color ribbon printer/ 5 lps
- 4 key independent memory
- Percent, backspace, tax +/-
- Auto averaging, constants
- Item count, date/non-add
- Decimal select, rounding

- Markup, group/grand total
- Black with recycled plastic
- 6 month limited warranty
- 9.5" x 15" x 3.7" / 4 lbs
- Uses: MNEAR12225 paper
- MNEM33X ribbon

MNE8130X (Ivory).....**\$259.00**

8145X Heavy Duty Desktop Printing Calculator

ITEM NO.
MNE8145XB

\$329⁰⁰



- 14 digit display
- 2 color ribbon printer/ 5 lps
- (2) 4 key independent memories
- Percent, backspace, tax +/-
- Auto averaging, constants
- Item count, date/non-add
- Decimal select, rounding

- Markup, group/grand total
- Black with recycled plastic
- 6 month limited warranty
- 9.5" x 15" x 3.7" / 4 lbs
- Uses: MNEAR12225 paper
- MNEM33X ribbon



12-DIGIT HANDHELD



6120X



122PDX



2020PlusX



8130X



8145X



UltimateX



M33X



Angled Foam Pads

THE MONROE X SERIES

THE BEST JUST GOT BETTER

The **Monroe X Series** dramatically improves the most important aspects of a **printing calculator experience**.

- Longest life expectancy of any printing calculator on the market
- Independent adding machine and calculator functionality
- Universal supplies including ribbon cartridges with heaviest inking degree throughout the industry and paper rolls with the thickest stock
- Large, bright displays and fast print speeds.

Monroe is dedicated to superior customer care. Every Monroe printing calculator comes with **FREE lifetime phone support** with a real calculator expert, never a machine.

CONTACT US

(888) 666-7631

monroe-systems.com

MONROE
Systems for Business

© 2021 Monroe Systems for Business. All rights reserved.

EL-233SB *Handheld Basic Calculator*

ITEM NO. SHREL233 LIST \$4.92

\$4⁹²



- 8 digit display
- Battery powered (LR1130)
- 3 key independent memory
- Percent, square root keys
- Constant calculation

- Auto power-off
- White with light gray keys
- 1 year limited warranty
- 2.4" x 0.3" x 4" / 1 oz

EL-243SB *Handheld Basic Calculator*

ITEM NO. SHREL243 LIST \$6.61

\$6⁶¹



- 8 digit display
- Dual powered (LR1130)
- 3 key independent memory
- Percent, square root keys
- Sign change

- Auto power-off
- Attached hard cover
- Putty with dark blue keys
- 1 year limited warranty
- 2.5" x 0.4" x 4" / 1.8 oz

EL-244WB *Professional Series Calculator*

ITEM NO. SHREL244 LIST \$8.25

\$8²⁵



- 8 digit large display
- Dual powered (LR1130)
- 3 key independent memory
- Mercury and Lead free
- Percent, tax +/- keys
- Rate set/recall function

- Auto power-off
- White
- 1 year limited warranty
- 2.4" x 0.4" x 4" / 1.6 oz

EL-240SAB *Handheld Basic Calculator*

ITEM NO. SHREL240 LIST \$8.58

\$8⁵⁸



- 8 digit ex-large display
- Dual powered (LR1130)
- 3 key independent memory
- Percent, square root keys
- Sign change, slant display

- Last answer function
- Putty with light blue keys
- 1 year limited warranty
- 2.8" x 0.6" x 4.6" / 2 oz

EL-S10BBL *Handheld Basic Calculator*

ITEM NO. SHRELS10BBL LIST \$8.88

\$8⁸⁸



- 8 digit ex-large display
- Battery powered (LR1130)
- 3 key independent memory
- Percent, square root keys
- Sign change, auto power-off
- Durable hard plastic keys
- Attached protective cover

- Translucent blue design
- 1 year limited warranty
- 2.8" x 0.4" x 4.2" / 2 oz

EL-377WB *Professional Series Calculator*

ITEM NO. SHREL377WB LIST \$10.66

\$10⁶⁶



- 10 digit large display
- Dual powered (LR1130)
- 4 key independent memory
- Percent, square root keys
- Backspace, auto constants
- Rate set/recall, tax +/- keys

- Double zero, auto power-off
- White
- 1 year limited warranty
- 2.8" x 0.4" x 4.6" / 2 oz

EL-310WB *Professional Series Mini-desktop Calculator*

ITEM NO. SHREL310WB LIST \$14.35

\$14³⁵



- 8 digit slant display
- Dual powered (LR44)
- 4 key independent memory
- Percent, square root keys
- Backspace, auto constants

- Rate set/recall, tax +/- keys
- Double zero, auto power-off
- White
- 1 year limited warranty
- 3.4" x 4.6" x 1" / 3 oz

EL-S25BBL *Math Quiz Basic Calculator*

ITEM NO. SHRELS25BBL LIST \$17.78

\$17⁷⁸



- 10 digit display
- Dual powered
- Ideal for elementary students
- Percent, square root, pi keys
- Flash card math learning
- Multiplication table quiz

- 25, 50 or 100 question drills
- Fits nicely in kids hands
- Bright electric blue
- 1 year limited warranty
- 3" x 5" x 1" / 4 oz

EL-760RBBL Professional Desktop Calculator

ITEM NO. SHREL760RBBL LIST \$11.42

\$11⁴²



- 8 digit large display
- Dual powered (LR1130)
- 3 key independent memory
- Percent, tax +/- keys
- Sign change, square root keys
- Auto power-off
- Dark/light blue
- 1 year limited warranty
- 2.9" x 4.8" x 1" / 2.5 oz

EL-330WB Professional Series Semi-desktop Calculator

ITEM NO. SHREL330WB LIST \$16.89

\$16⁸⁹



- 8 digit slant display
- Dual powered (LR44)
- 4 key independent memory
- Cost-sell-margin, backspace
- Percent, sign change keys
- Rate set/recall, tax +/- keys
- 3.9" x 6" x 1.3" / 4.4 oz
- White
- 1 year limited warranty
- 3.9" x 6" x 1.3" / 4.4 oz

EL-334W Professional Series Semi-desktop Calculator

ITEM NO. SHREL334W LIST \$19.58

\$19⁵⁸



- 12 digit large display
- Dual powered (LR44)
- 4 key independent memory
- Percent, sign change keys
- Cost-margin, grand total
- Rate set/recall, tax +/- keys
- Backspace, double zero
- White with kick stand
- 1 year limited warranty
- 4.38" x 6.63" x 1" / 8 oz

EL-M335BBL Extra Large Desktop Calculator

ITEM NO. SHRELM335BBL LIST \$19.04

\$19⁰⁴



- 10 digit large display
- Dual powered (LR44)
- 3 key independent memory
- Percent, tax +/- keys
- Backspace, sign change
- Currency conversion
- Auto power-off
- Blue
- 1 year limited warranty
- 3.8" x 5.8" x 0.94" / 4.4 oz

EL-344RB Handheld Metric Conversion Calculator

ITEM NO. SHREL344 LIST \$22.87

\$22⁸⁷



- 10 digit fraction display
- Dual powered (LR1130)
- 3 key independent memory
- Percent, square root keys
- Sign change, rate set/recall
- 44 built-in conversions
- Fractions, weight, volume
- Measurement, temperature
- Metal finish w/wallet case
- 1 year limited warranty
- 2.8" x 0.2" x 4.8" / 3 oz

EL-339HB Executive Desktop Display Calculator

ITEM NO. SHREL339 LIST \$25.40

\$25⁴⁰



- 12 digit large display
- Dual powered (LR44)
- 4 key independent memory
- Percent, double zero keys
- Cost-sell-margin, sign change
- Decimal select, rounding
- Answer check, grand total
- Metal finish with kick stand
- 1 year limited warranty
- 4.3" x 7" x 0.7" / 6 oz

VX-2128V Desktop Display Calculator

ITEM NO. SHRVX2128V LIST \$83.87

\$83⁸⁷



- 12 digit adjustable display
- Dual powered
- 4 key independent memory
- Percent, square root keys
- Multi-Use, sign change, tax +/-
- Decimal select, rounding
- Day/date, backspace, resume
- Answer check, grand total
- Silver with kick stand
- 1 year limited warranty
- 5.7" x 6.9" x 1" / 1 lb

QS-2130 Desktop Display Calculator

ITEM NO. SHRQS2130 LIST \$100.36

\$100³⁶



- 12 digit tilt display
- Dual powered
- 4 key independent memories
- Additional 2 key memories
- Percent, square root, rounding
- Multi-Use, sign change keys
- Decimal select, item count
- Constant and sigma modes
- Light gray with kick stand
- 1 year limited warranty
- 7.3" x 6.9" x 0.7" / 9 oz

EL-501X2BWH Scientific Calculator w/ White Trim

ITEM NO. SHREL501X2B LIST \$12.70

\$12⁷⁰



- 10 digit LCD display
- Normal and stat modes
- Battery powered (1130)
- 146 functions, 1 memory
- General math, trigonometry
- Algebra, science, statistics
- Constant, chain calculations
- Complex, random numbers
- Exponents, sin, cos, tan, log
- DEG, RAD, GRAD, DMS
- Black w/protective hard case
- 1 year limited warranty
- 3" x 0.5" x 6" / 4 oz

EL-531TGBBW Scientific Calculator

ITEM NO. SHREL531TGBBW LIST \$17.78

\$17⁷⁸



- 12 digit x 2 line display
- Dual powered
- 272 functions, 9 memories
- Algebra, geometry, trigonometry
- Science, biology, chemistry
- 1 & 2 variable statistics
- Constant, Chain, Fraction
- Playback and edit feature
- Direct algebraic logic
- Black/white trim, hard cover
- 1 year limited warranty
- 3" x 6" x 0.5" / 4 oz

SHREL531TGBDW.....**\$17.78**

EL-506TSBBW Advanced Scientific Calculator

ITEM NO. SHREL506TSBBW LIST \$27.94

\$27⁹⁴



- 12 digit x 2 line display
- Dual powered
- 470 functions, 9 memories
- Algebra, geometry, statistics
- Science, calculus, trigonometry
- Fractions, complex numbers
- Quadratic, cubic solvers
- Matrix and list calculations
- Direct algebraic logic
- Black/white trim, hard cover
- 1 year limited warranty
- 3" x 6" x 0.5" / 4 oz

EL-W535TGB-BL Scientific Calculator w/ WriteView™

ITEM NO. SHRELW535TGBBL LIST \$27.94

\$27⁹⁴



- 16 digit x 4 line display
- WriteView™ Display
- 422 functions, 8 memories
- Algebra, statistics, geometry
- Trigonometry, biology, chemistry
- Constant, Chain, Fraction
- Normal, drill, stat modes
- Playback and edit feature
- Black with blue trim
- 1 year limited warranty
- 3.1" x 6.1" x 0.6" / 4 oz

EL-W516TB-SL Advanced Scientific Calculator w/WriteView™

ITEM NO. SHRELW516TBSL LIST \$35.57

\$35⁵⁷



- 16 digit x 4 line display
- WriteView™ Display
- 640 functions, 8 memories
- Algebra, calculus, trigonometry
- Geometry, physics, statistics
- 52 constants, 44 conversions
- Normal, complex, drill, stat
- Matrix, list, equation modes
- Black with silver trim
- 1 year limited warranty
- 3.1" x 6.4" x 0.6" / 4 oz

EL-738FB Handheld Financial Calculator

ITEM NO. SHREL738 LIST \$50.82

\$50⁸²

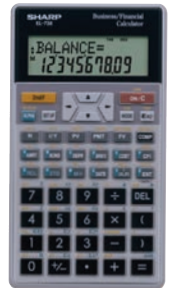

- 10 digit x 2 line display
- Battery powered (CR2032)
- Percent, sign change keys
- Cost-sell-margin, markup
- Statistics, linear regressions
- Amortization, depreciation
- Cash flow, interest, conversions
- 12 memory with playback
- Gray with wallet case
- 1 year limited warranty
- 3" x 6" x 0.4" / 4 oz

EL-1611V Handheld Printing Calculator

ITEM NO. SHREL1611V LIST \$57.17

\$57¹⁷



- 12 digit display
- 2 color ink roll printer/ 2.0 lps
- 4 key independent memory
- Grand total, double zero
- Percent, tax calculation
- Decimal select, rounding
- Auto power-off
- (4) AA batteries included
- Gray
- 6 month limited warranty
- 3.7" x 7" x 1.5" / 1.7 lbs

EL-1501 Desktop Paperless Printing Calculator

ITEM NO. SHREL1501 LIST \$73.17

\$73¹⁷



- 12 digit blue LCD
- 5-line scrolling display
- View up to 300 prior entries
- Whisper quiet / 2.5 lps
- 4 key independent memory
- Percent, rate set, tax +/- keys
- Cost-sell-margin, sign change
- Decimal select, rounding
- Item count, sub/grand total
- Battery powered (4) AA
- 6 month limited warranty
- 5.9" x 9" x 2.4" / 1.5 lbs

EL-1750V Desktop Printing Calculator

ITEM NO. SHREL1750V LIST \$93.43

\$93⁴³

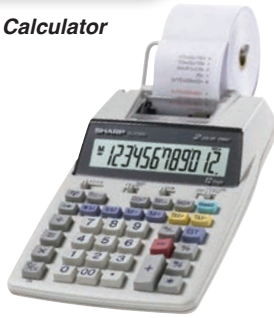

- 12 digit display
- 2 color ink roll printer/ 2.0 lps
- 4 key independent memory
- Percent, markup, tax rate +/-
- Cost-sell-margin, sign change
- Decimal select, rounding
- Item count, grand total

- Clock/calendar, change key
- Optional battery operation
- 6 month limited warranty
- 5.9" x 8.9" x 2" / 1 lb
- CIMIR40T roller, ZB2150 paper

EL-1901 Desktop Paperless Printing Calculator

ITEM NO. SHREL1901 LIST \$91.78

\$91⁷⁸



- 12 digit display
- 5-line LCD secondary display
- Check & correct 300 entries
- 4 key independent memory
- Cost-sell-margin, sign change
- Percent, tax rate +/-

- Decimal select, rounding
- Grand total, change key
- Light gray
- 6 month limited warranty
- 7.6" x 10" x 2.5" / 2 lbs

EL-1801V Desktop Printing Calculator

ITEM NO. SHREL1801V LIST \$110.30

\$110³⁰



- 12 digit display
- 2 color ink roll printer/ 2.1 lps
- 4 key independent memory
- Percent, averaging, tax rate +/-
- Cost-sell-margin, sign change
- Decimal select, rounding
- Item count, sub/grand total

- Clock/calendar, change key
- Light gray
- 6 month limited warranty
- 7.6" x 10" x 2.5" / 2 lbs
- CIMIR40T roller, ZB2150 paper

EL-2196BL Desktop Printing Calculator

ITEM NO. SHR2196BL LIST \$140.35

\$140³⁵



- 12 digit display
- 2 color ribbon printer/ 3.7 lps
- 4 key independent memory
- Percent, rate set, tax +/- keys
- Multi-Use, left total, sign change
- Decimal select, rounding
- Item count, sub/grand total

- Clock/calendar function
- 6 month limited warranty
- 8.8" x 12.9" x 3" / 4 lbs
- GRCE201 ribbon, ZB2150 paper

EL-1197PIII Heavy Duty Printing Calculator

ITEM NO. SHR1197P LIST \$143.15

\$143¹⁵



- 12 digit display
- 2 color ribbon printer/ 4.3 lps
- 4 key independent memory
- Percent, averaging, tax rate +/-
- Markup, left total, sign change
- Decimal select, rounding
- Item count, sub/grand total
- Clock/calendar function

- White
- 6 month limited warranty
- 8.8" x 13" x 3" / 4 lbs
- GRCE201 ribbon, ZB2150 paper

EL-2630PIII Commercial Printing Calculator

ITEM NO. SHR2630P LIST \$192.47

\$192⁴⁷



- 12 digit display
- 2 color ribbon printer/ 4.8 lps
- 4 key independent memory
- Percent, conversions, tax +/-
- Mark up, left total, sign change
- Decimal select, rounding
- Item count, sub/grand total
- Clock/calendar, averaging

- Light gray
- 6 month limited warranty
- 9" x 13" x 3" / 4 lbs
- GRCE201 ribbon, ZB2150 paper

VX-2652H Commercial Printing Calculator

ITEM NO. SHRVX2652H LIST \$236.56

\$236⁵⁶



- 12 digit display
- 2 color ribbon printer/ 4.8 lps
- (2) 4 key independent memories
- Percent, rate store key, tax+
- Mark up, left total, sign change
- Decimal select, rounding
- Item count, sub/grand total

- Light gray
- 6 month limited warranty
- 9.8" x 13.6" x 3" / 4 lbs
- GRCE201 ribbon, ZB2150 paper

QS-2770H Desktop Printing Calculator

ITEM NO. SHRQS2770H LIST \$355.54

\$355⁵⁴

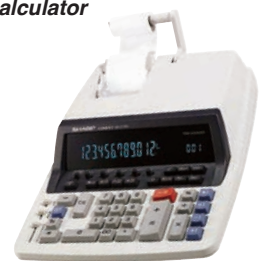

- 12 digit display
- 2 color ribbon printer/ 4.8 lps
- (2) 4 key independent memories
- Percent, average, tax rate +/-
- Mark up, left total, sign change
- Decimal select, rounding
- Item count, sub/grand total

- First factor accumulation, date
- White
- 6 month limited warranty
- 10" x 13" x 3" / 5 lbs
- GRCE201 ribbon, ZB2150 paper

SHRQS2760H (12 digit).....\$318.19

TI-503SV *Handheld Basic Calculator*

ITEM NO.
TEXTI503SV

\$5⁰⁰



- 8 digit SuperView™ display
- Battery powered
- 3 key independent memory
- Percent and square root

- Sign change key
- Well-spaced rubber keys
- Auto power-down
- Bright blue/white

- 1 year limited warranty
- 3" x 0.8" x 4.8" / 1 oz

TI-1706SV *Handheld Calculator*

ITEM NO.
TEXTI1706SV

\$10⁰⁰



- 8 digit SuperView™ display
- Dual powered
- 3 key independent memory
- Percent and square root
- Sign change key
- Well-spaced color coded keys

- Protective case stores on back
- Silver/blue
- 1 year limited warranty
- 3" x 0.8" x 5.8" / 2 oz

TI-1795SV *Mini-Desktop Calculator*

ITEM NO.
TEXTI1795SV

\$15⁰⁰



- 8 digit angled display
- Dual powered
- 3 key independent memory
- Percent, square root keys
- Sign change, rate, tax +/-
- Well-spaced contoured keys

- Auto power-down
- Silver/white
- 1 year limited warranty
- 4.8" x 5.6" x 1" / 3 oz

TI-30XA *Handheld Scientific Calculator*

ITEM NO.
TEXTI30XA

\$15⁰⁰



- 10 digit display
- Battery powered
- General math, trigonometry
- Science, algebra, statistics
- Exponentials, hyperbolics
- Logarithms, reciprocals
- Factorials, conversions

- 3 memory values
- Gray with slide case
- 1 year limited warranty
- 3" x 0.8" x 6" / 4 oz

TI-36XPRO *Advanced Scientific Calculator*

ITEM NO.
TEXTI36XPRO

\$25⁰⁰



- 16 digit x 4 line scroll display
- Dual powered w/auto-off
- Formulas displayed as written
- Ideal for highschool & college
- Vector & matrix entry window
- 9 constants, 18 conversions
- Numeric, polynomial, linear

- Store, recall, edit values
- 7 memory variables
- Black with snap-on cover
- 1 year limited warranty
- 3.5" x 0.8" x 7" / 4 oz

TI-BAIL Plus™ *Financial Calculator*

ITEM NO.
TEXTIBA2PLUS

\$45⁰⁰

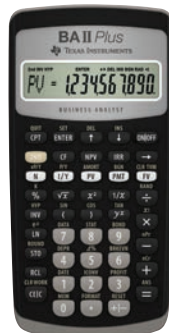

- 10 digit display
- Battery powered (CR2032)
- 10 user memories
- Real estate, business, banking
- Statistics and economics
- Amortizations, depreciations
- Cash flows, bonds, interest

- Chain or algebraic entry
- Black with slide case
- 1 year limited warranty
- 3" x 0.6" x 6" / 3 oz

TI-BAIL Plus™ Prof *Professional Financial Calculator*

ITEM NO.
TEXTIBA2PROF

\$70⁰⁰



- 10 digit display
- Battery powered (CR2032)
- 10 user memories
- Real estate, accounting, banking
- Statistics, business, economics
- Amortizations, depreciations
- Cash flows, bonds, interest

- Chain or algebraic entry
- Black plastic case
- 1 year limited warranty
- 3" x 0.6" x 6" / 3 oz

TI-108TK Educational Calculator
10 Calc Teachers Kit

ITEM NO.
TEXT1108TK

\$75⁰⁰



- 8 digit display
- ANYLITE™ solar powered
- 3 key independent memory
- Percent and square root
- Color coded plastic keys
- Suitable for grades K-3

- Bright blue
- 1 year limited warranty
- 2.6" x 0.4" x 4.4" / 2 oz
- Kit includes: 10 calcs w/caddy teacher's guide & poster

TI-10TK Educational Calculator
10 Calc Teachers Kit

ITEM NO.
TEXT110TK

\$154⁰⁰



- 11 digit x 2 line scroll display
- Dual powered
- Difficulty level, placed value
- Parentheses, greater/less than
- Constant operation, conversions
- Problem solving feature
- Suitable for grades K-5

- Bright red
- 1 year limited warranty
- 3.5" x 0.7" x 6.9" / 3 oz
- Kit includes: 10 calcs w/caddy teacher's guide & poster

TI-15TK Explorer Calculator 10 Calc Teachers Kit

ITEM NO.
TEXT115TK

\$199⁵⁰



- 11 digit x 2 line scroll display
- Dual powered
- Difficulty level, placed value
- Integer division, parentheses
- Stacked fractions, conversions
- Problem solving feature
- Suitable for grades 3-6
- Light blue w/color coded keys

- 1 year limited warranty
- 3.4" x 0.7" x 5.5" / 4 oz
- Kit includes: 10 calcs w/caddy teacher's guide & poster

TI-30XIIS Scientific Calculator

ITEM NO.
TEXT130XIIS

\$20²⁹



- 11 digit x 2 line scroll display
- Dual powered
- General math, trigonometry
- Geometry, algebra, statistics
- Exponentials, hyperbolics
- Logarithms, reciprocals

- Factorials, conversions
- Store, recall, edit values
- 5 memory variables
- 1 year limited warranty
- 3.2" x 0.7" x 6" / 5 oz

TEXT130XIISTK (10 Calc Teachers Kit)..... **\$202.90**

TI-30XSMV MultiView™ Scientific Calculator

ITEM NO.
TEXT130XSMV

\$20⁰⁰



- 16 digit x 4 line scroll display
- Dual powered
- Formulas displayed as written
- Algebra, science, statistics
- Exponentials, hyperbolics
- Logarithms, reciprocals

- Factorials, conversions
- Store, recall, edit values
- 7 memory variables
- 1 year limited warranty
- 3.5" x 0.8" x 7" / 4 oz

TEXT130XSMVTK (10 Calc Teachers Kit)..... **\$200.00**

TI-34MV MultiView™ Fraction Calculator

ITEM NO.
TEXT134MV

\$25⁰⁰



- 16 digit x 4 line scroll display
- Dual powered
- Formulas displayed as written
- Ideal for middle grade math
- Algebra, geometry, statistics
- Logarithms, reciprocals

- Factorials, conversions
- Store, recall, edit values
- 7 memory variables
- 1 year limited warranty
- 3.4" x 0.9" x 6.7" / 4 oz

TEXT134MVTK (10 Calc Teachers Kit)..... **\$250.00**

TI-CBR2 Sonic Motion Detector

ITEM NO.
TEXT1CBR2

\$130⁰⁰



- Measure, view, analyze data
- Distance, velocity, acceleration
- Algebra, calculus, statistics
- Physical science and physics
- Record data from 15cm to 6m

- Use w/graph match & ball-toss
- Pivoting head sensor
- Battery powered (4) AA
- 1 year limited warranty
- 2" x 2" x 6" / 7 oz

TI-CBL2 Data Collection Device

ITEM NO.
TEXT1CBL2

\$250⁰⁰



- Gather, gauge real-world data
- Light, temp & voltage sensors
- 3 analog channels
- Built-in regression models/stats
- Compatible with 40+ sensors
- Explore math/science concepts

- Analyze and conclude effects
- Battery powered (4) AA
- Portable with support stand
- 1 year limited warranty
- 3" x 8" x 1" / 8 oz

TI-83 Plus *Graphing Calculator*

ITEM NO.
TEXTI83PL

\$149⁹⁵

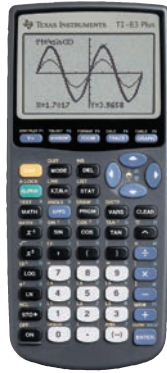

- 16 digit x 8 line scroll display
- Battery powered (4) AAA
- Statistical, financial analysis
- Data plotting, equation solver
- Complex numbers, multi-graph
- Electronically upgradable
- 160Kb, cable
- 1 year limited warranty
- 3.5" x 1" x 7.4" / 8 oz
- CBR2, CBL2 system compatible

TEXTI83PLTK (10 Calc Teachers Kit) **\$1,499.99**

TI-84 Plus *Graphing Calculator*

ITEM NO.
TEXTI84PLUS

\$150⁰⁰



- 16 digit x 8 line scroll display
- Battery powered (4) AAA
- Statistical, financial analysis
- Data plotting, equation solver
- Complex numbers, multi-graph
- Electronically upgradable
- 480Kb, USB port, cable
- 1 year limited warranty
- 3" x 0.9" x 7.5" / 8 oz
- CBR2, CBL2 system compatible

TEXTI84PLUSTK (10 Calc Teachers Kit) **\$1,499.99**

TI-84 Plus CE Python *Color Graphing Calculator*

ITEM NO.
TEXTI84PLCEPY

\$160⁰⁰



- 320 x 240 pixels display
- Python program language
- Learn in any environment
- Ideal for STEM exploration
- Graph in 15 vibrant colors
- Display symbols as written
- Portable coding on the go
- Distraction-free focus
- Analyze real-world data
- TI battery rechargeable
- 3 Mb, connectivity cable
- 1 year limited warranty
- CBR2 system compatible

TEXTI84PLCEPYTK (10 Calc Teachers Kit) **\$1,780.00**

TI-Nspire™ CX II *Color Graphic Calculator*

ITEM NO.
TEXTINSPIRECXII

\$175⁰⁰

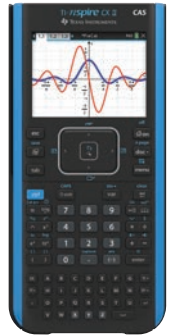

- 3.2" full color backlit display
- Easy touchpad navigation
- Overlay real-world images
- Graphs, plots and regressions
- 3D graph & rotate, 15 colors
- Algebraic, statistical operations
- Geometric, numeric, written
- 100 Mb storage memory
- USB data transfer/upgrades
- Built-in rechargeable battery
- 1 year limited warranty
- 3.4" x 0.6" x 7.5" / 10 oz

TEXTINSPIRECXIITK (10 Calc Teachers Kit) **\$1,800.00**

TI-89T *Titanium Graphing Calculator*

ITEM NO.
TEXTI89T

\$190⁰⁰



- 100 x 160 pixel display
- Battery powered (4) AAA
- Advanced math, engineering
- Calculus, algebra, statistics
- Deep recall, 3-D, multi-graph
- Electronically upgradable
- 2.7Mb, USB port, cable
- 1 year limited warranty
- 3.5" x 1" x 7" / 8 oz
- CBR2, CBL2 system compatible

TI-Nspire™ CXIICAS *Color Graphic Calculator*

ITEM NO.
TEXTINSPIRECXIICAS

\$185⁰⁰



- Computer Algebra System (CAS)
- 3.2" full color backlit display
- Easy touchpad navigation
- Overlay real-world images
- Graphs, plots and regressions
- 3D graph & rotate, 15 colors
- Algebraic, statistical operations
- Geometric, numeric, written
- 100 Mb storage memory
- USB data transfer/upgrades
- Built-in rechargeable battery
- 1 year limited warranty
- 3.4" x 0.6" x 7.5" / 10 oz

TEXTINSPIRECXIICASTK (10 Calc Teachers Kit) **\$1,899.00**

Call Your Sales Representative Today

700 Professional Handheld Calculator

ITEM NO.
VCT700

\$5⁹⁹



- 8 digit large display
- Hybrid powered
- 3 key independent memory
- Percent and square root
- Sign change key

- Non-slip rubber keys
- White/black
- 2 year limited warranty
- 2.5" x 0.3" x 4" / 2 oz

900 Green Compact Pocket Calculator

ITEM NO.
VCT900

\$7⁸⁵



- 8 digit ex-large display
- Hybrid powered
- 3 key independent memory
- Made of 50% recycled plastic
- Percent, square root keys

- Auto constants, sign change
- Black w/hard slide cover
- 2 year limited warranty
- 2" x 0.3" x 4" / 2 oz

920 Scientific Calculator

ITEM NO.
VCT920

\$8⁴⁶



- 10 digit large display
- Hybrid powered
- Bin/Oct/Dec/Hex
- Algebra, trigonometry
- One-variable statistics
- Degrees, powers, roots

- Logarithms, reciprocals
- Factorials, conversions
- Black w/hinged hard cover
- 2 year limited warranty
- 2.6" x 0.5" x 4.5" / 2 oz

1000 Green Mini Desktop Calculator

ITEM NO.
VCT1000

\$11⁹⁶



- 8 digit large angled display
- Hybrid powered
- 3 key independent memory
- Made from 50% recycled plastic
- Percent and square root

- Sign change key
- Contoured keys
- Black/silver
- 2 year limited warranty
- 3" x 1" x 4" / 2 oz

908 Handheld Calculator

ITEM NO.
VCT908

\$11⁸³



- 8 digit large display
- Hybrid powered
- 3 key independent memory
- Percent and square root
- Auto constants, sign change

- Durable rubber keys
- Double hinged snap cover
- Black/silver
- 2 year limited warranty
- 3" x 0.5" x 5" / 3 oz

940 Scientific Calculator

ITEM NO.
VCT940

\$12⁰⁸



- 10 +2 digit x 2 line display
- Hybrid powered
- 240 scientific functions
- General math, trigonometry
- Geometry, algebra, statistics
- Exponentials, hyperbolics
- Parentheses, fraction functions

- Store, recall, edit values
- White w/hard slide cover
- 2 year limited warranty
- 3.6" x 6" x 0.6" / 3 oz

1100-3A Green Mini Desktop Calculator

ITEM NO.
VCT1100-3A

\$15⁷⁰

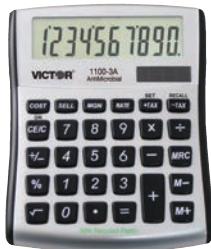

- 10 digit angled display
- Hybrid powered
- 3 key independent memory
- Made from 50% recycled plastic
- Cost-sell-margin, percent

- Sign change, tax rate, tax +/-
- Contemporary silver/black
- 2 year limited warranty
- 3" x 0.3" x 4" / 3 oz

930-2 Scientific Calculator

ITEM NO.
VCT930-2

\$20³⁰



- 10 digit large display
- Hybrid powered
- 154 scientific functions
- Algebra, trigonometry
- One-variable statistics
- Degrees, powers, roots
- Logarithms, reciprocals

- Factorials, conversions
- Black w/hard slide cover
- 2 year limited warranty
- 3" x 0.5" x 6" / 6 oz

1180-3A *Green Desktop Business Analyst*

ITEM NO.
VCT1180-3A

\$22⁷²



- 12 digit angled display
- Hybrid powered
- 3 key independent memory
- Made from 40% recycled plastic
- Anti-microbial protection
- Percent, square root keys
- Cost-sell-margin, rounding

- Auto constants, sign change
- Decimal select, item count
- 2 year limited warranty
- 5" x 0.8" x 6.5" / 5 oz

99901 *TuffCalc™ Water/Shock Resistant Calculator*

ITEM NO.
VCT99901

\$22⁰³



- 12 digit large angled display
- Hybrid powered
- 3 key independent memory
- Percent, square root, tax +/-
- Sign change, grand total
- Water and shock resistant
- Sealed rubber keypad

- Soap and water washable
- 2 year limited warranty
- 4" x 2" x 6.5" / 6 oz

2140 *Desktop Calculator*

ITEM NO.
VCT2140

\$25³⁸



- PC touch keys
- 12 digit display
- Hybrid powered
- 4 key independent memory
- Percent, backspace, rounding
- Decimal select, sign change

- Mark up, grand total
- Auto constants
- Off white
- 2 year limited warranty
- 6" x 7.5" x 1.6" / 8.6 oz

6400 *Desktop Calculator*

ITEM NO.
VCT6400

\$24¹⁷



- 12 digit ex-large tilt display
- Make corrections/recalculates
- Hybrid powered
- Made from 50% recycled plastic
- 3 key independent memory
- Percent, square root

- Decimal select, backspace
- Auto constants, replay
- White w/silver trim
- 2 year limited warranty
- 4.25" x 7" x 2" / 6 oz

6500 *Executive Desktop Calculator*

ITEM NO.
VCT6500

\$30²²

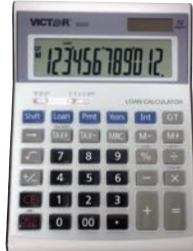

- 12 digit ex-large tilt display
- Hybrid powered
- 3 key independent memory
- Percent, square root, tax +/-
- Decimal select, sign change
- Loan Wizard, grand total

- Loan, payment, years, interest
- Smooth touch keyboard
- Brushed metal faceplate
- 2 year limited warranty
- 5" x 8" x 1.8" / 10 oz

1200-4 *Green Professional Desktop Calculator*

ITEM NO.
VCT1200-4

\$37⁴⁷



- 12 digit large tilt display
- Hybrid powered
- 4 key independent memory
- Made from 50% recycled plastic
- Percent, cost-sell-margin
- Sign change, grand total

- Decimal select, rounding
- 2 independent tax rates
- Review/edit up to 99 entries
- 2 year limited warranty
- 7" x 7" x 0.5" / 10 oz

6700 *Desktop Calculator*

ITEM NO.
VCT6700

\$44⁷³

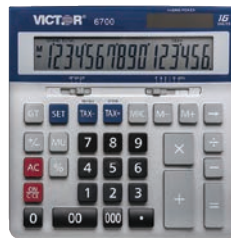

- 16 digit ex-large display
- Hybrid powered
- 3 key independent memory
- Percent, backspace, tax +/-
- Decimal select, sign change
- Mark up, grand total

- Auto constants
- Blue/silver
- 2 year limited warranty
- 7.25" x 7.5" x 1.6" / 6 oz

C6000 *Advanced Construction Calculator*

ITEM NO.
VCTC6000

\$62⁹⁹



- 8+ digit LCD display
- Shows fractions or decimals
- Battery powered (2) LR44
- Convert between dimensions
- Area, volume, perimeter
- Weight, roof, rafter, framing

- Stairs, right angle, circular
- Cost of materials calculations
- Concrete, block, drywall, footing
- Orange w/ protective case
- 2 year limited warranty
- 3.5" x 0.8" x 6.5" / 4.5 oz

Call Your Sales Representative Today

LS-125 Large Calculator Stand

ITEM NO.
VCTLS125

\$196¹



- Stylish ergonomic design
- Durable clear acrylic
- Angled for optimal operation

- Reduces glare and eye fatigue
- Fits any large size calculator
- 9" x 11" x 2" / 9 oz

108TK Educational 10 Calc Teachers Kit

ITEM NO.
VCT108TK

\$78⁵⁸



- Easy-to-read 8 digit display
- Hybrid powered
- 3 key independent memory
- Made from 50% recycled plastic
- Percent and square root keys
- Auto constants, sign change

- Color coded plastic keys
- Bright blue w/slide-on case
- 2 year limited warranty
- 2.8" x 0.5" x 4.8" / 2.7 oz
- Kit includes: 10 calcs w/caddy
- Teacher guide class exercises PDF

1205-4 Green Portable Palm/Desktop Printing Calculator

ITEM NO.
VCT1205-4

\$41⁸⁶



- 12 digit large display
- 1 color ink roll printer/ 2.0 lps
- 3 key independent memory
- Made from 25% recycled plastic
- Percent, non-add/subtotal
- Cost-sell-margin, tax +/-

- Auto constants, backspace
- Optional battery operation
- 2 year limited warranty
- 4" x 8" x 1.8" / 8 oz
- CIMIR40 roller, ZB2150 paper

1208-2 Portable Compact Printing Calculator

ITEM NO.
VCT1208-2

\$59⁵⁰



- 12 digit ex-large display
- 2 color ink roll printer/ 2.3 lps
- 4 key independent memory
- Made from 20% recycled plastic
- Percent, sign change, tax +/-
- Cost-sell-margin, time/date
- Auto constants, backspace

- Date/non-add, item count
- Optional battery operation
- 2 year limited warranty
- 6" x 7.5" x 1.5" / 1 lb
- CIMIR40T roller, ZB2150 paper

1212-3A Green Portable Printing Calculator

ITEM NO.
VCT1212-3A

\$84⁰⁸



- 12 digit large display
- 2 color ink roll printer/ 2.7 lps
- 4 key independent memory
- Made from 45% recycled plastic
- Anti-microbial protection
- Cost-sell-margin, time/date
- Percent, sign change, tax +/-

- Item count, grand total
- Optional battery operation
- 2 year limited warranty
- 8" x 10" x 2.5" / 2 lbs
- CIMIR40T roller, ZB2150 paper

1225-3A Green Commercial Printing Calculator

ITEM NO.
VCT1225-3A

\$110¹⁸



- 12 digit large display
- 2 color ink roll printer/ 3.0 lps
- 4 key independent memory
- Made from 45% recycled plastic
- Anti-microbial protection
- Cost-sell-margin, time/date
- Percent, backspace, tax +/-

- Sign change, subtotal
- Item count, grand total
- 2 year limited warranty
- 8" x 10" x 2.5" / 2 lbs
- CIMIR40T roller, ZB2150 paper

1297 Commercial Printing Calculator

ITEM NO.
VCT1297

\$114⁹²



- 12 digit display
- 2 color ribbon printer/ 4.0 lps
- 4 key independent memory
- Equals plus logic, left side total
- Percent, sign change, non-add
- Cost-sell-margin, time/date
- 2 independent tax rates

- Item count, grand total
- Comparable to Sharp EL-1197
- 2 year limited warranty
- 8" x 11" x 3" / 2 lbs
- VCT7010 ribbon, ZB2150 paper

1310 Big Print™ Commercial Desktop Calculator

ITEM NO.
VCT1310

\$120³³



- 2 color, 10 or 12 digit display
- 1 color thermal printer/ 6.0 lps
- 150% larger print size
- 4 key independent memory
- Percent, sign change, delta
- Cost-sell-margin, time/date
- Backspace, date/non-add

- 2 independent tax rates
- Item count, grand total
- 2 year limited warranty
- 8" x 10" x 2" / 2 lbs
- Uses: PRNZT2085P paper

1230-4 Commercial Printing Calculator

ITEM NO.
VCT1230-4

\$134⁷⁴

- 12 digit large display
- 2 color ribbon printer/ 4.0 lps
- 4 key independent memory
- Percent, sigma, tax +/-
- Auto constants, sign change
- Cost-sell-margin, time/date
- Decimal select, rounding

- Backspace, date/non-add
- Item count, grand total
- 2 year limited warranty
- 8.5" x 12" x 3" / 2 lbs
- VCT7010 ribbon, ZB2150 paper



2640-2 Heavy Duty Printing Calculator

ITEM NO.
VCT2640-2

\$155²³

- 12 digit ex-large display
- 2 color ribbon printer/ 4.6 lps
- 4 key independent memory
- Equals plus logic
- Left side total, sign change
- Cost-sell-margin, time/date
- Markup/gross profit margin

- 2 independent tax rates
- Item count, grand total
- 3 year limited warranty
- 8" x 11" x 3" / 3 lbs
- VCT7010 ribbon, ZB2150 paper



1260-3 Heavy Duty Printing Calculator

ITEM NO.
VCT1260-3

\$155²³

- 12 digit large display
- 2 color ribbon printer/ 4.6 lps
- 4 key independent memory
- Percent, sign change keys
- Auto constants, grand total
- Cost-sell-margin, time/date
- Backspace, date/non-add

- 2 independent tax rates
- Item count w/averaging
- 3 year limited warranty
- 8" x 11" x 2.8" / 4 lbs
- VCT7010 ribbon, ZB2150 paper



1240-3A Green Heavy Duty Printing Calculator

ITEM NO.
VCT1240-3A

\$161⁸⁶

- 12 digit large display
- 2 color ribbon printer/ 4.5 lps
- 4 key independent memory
- Made from 45% recycled plastic
- Anti-microbial protection
- Cost-sell-margin, time/date
- Markup/gross profit margin

- Percent, sigma, tax +/-
- Item count, grand total
- 3 year limited warranty
- 9" x 12.8" x 3" / 4 lbs
- VCT7010 ribbon, ZB2150 paper



PL8000 Professional Printing Calculator w/Prompt Logic™

ITEM NO.
VCTPL8000

\$155²³

- 14 digit 2 color display
- 1 color thermal printer/ 8 lps
- 4 key independent memory
- Prompt Logic™, Loan Wizard
- Program, HELP, sign change
- Cost-sell-margin, time/date
- Custom messages, reprint

- 2 independent tax rates
- Item count, grand total
- 3 year limited warranty
- 8.8" x 13" x 4" / 3 lbs
- Uses: PRNZT2085P paper



1460-4 Green Heavy Duty Printing Calculator

ITEM NO.
VCT1460-4

\$194²³

- 12 digit huge display
- 2 color ribbon printer/ 4.6 lps
- 4 key independent memory
- Made from 45% recycled plastic
- Percent, sign change, sigma
- Cost-sell-margin, subtotal
- Backspace, date/non-add

- 2 independent tax rates
- Item count, grand total
- 3 year limited warranty
- 9" x 12" x 2" / 3 lbs
- VCT7010 ribbon, ZB2150 paper



1530-6 Professional Grade Printing Calculator

ITEM NO.
VCT1530-6

\$232⁷⁹

- 10 digit ex-large display
- 2 color ribbon printer/ 5.2 lps
- 4 key independent memory
- Percent, present/future value
- Auto constants, amortization
- Cost-sell-margin, time/date
- Financial/time calculations

- 2 independent tax rates
- Sign change, grand total
- 3 year limited warranty
- 9" x 12.5" x 3" / 3 lbs
- VCT7010 ribbon, ZB2150 paper



1560-6 Professional Grade Printing Calculator

ITEM NO.
VCT1560-6

\$257⁰⁷

- 12 digit ex-large display
- 2 color ribbon printer/ 5.2 lps
- 4 key independent memory
- Percent, present/future value
- Auto constants, amortization
- Cost-sell-margin, time/date
- Financial/time calculations

- 2 independent tax rates
- Sign change, grand total
- 3 year limited warranty
- 9" x 12.5" x 3" / 3 lbs
- VCT7010 ribbon, ZB2150 paper



VCT1570-6 (14 digit) **\$286.86**

Boost Performance & See Epic Savings

Whether You Are Doing Battle Daily from the HOME OFFICE or CORPORATE OFFICE



Saying the past year has made us adapt our business is an understatement. Many businesses have shifted to strict work-from-home environments, while those still in office settings are adapting to more personal printing rather than traditional shared printers. Regardless of the situation, NXT Premium Replacement Cartridges can provide you with significant savings without sacrificing on the professional performance you expect.

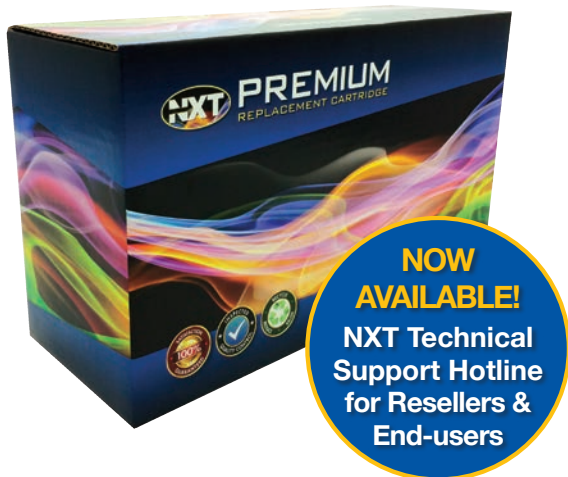

NXT Premium is the NeXT Best Thing in Toner

Others keep telling you that buying and selling their recycled toner is to your advantage, but NXT Premium Replacement Cartridges are quality-tested, performance certified cartridges that offer a Lifetime Warranty.

- 100% lifetime warranty
- Certified performance (ISO/STMC)
- Reduce printing costs up to 50%
- High quality new components
- Expanded U.S. distribution

www.NXTpremium.com

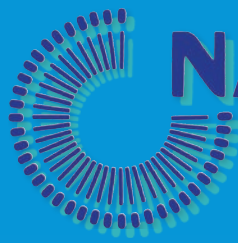

NAKAJIMA®

First in quality and reliability



For over 50 years, Nakajima has been the “behind the scenes” designer and manufacturer of many of the industry’s best known typewriter brands throughout the world. Built to quality standards that are the highest in the industry, Nakajima Typewriters offer versatility, reliability, performance, and unbeatable value. The OEM of choice is also the brand name of choice – Nakajima.

The WPT series office typewriters offer features that make typing fast and easy. These lightweight portables are heavyweight performers. Their 13” carriage gives 9” of typing width and has a variable 10/12/15 pitch selection. Key features include automatic centering and return, word erase, full line correction memory, relocate, automatic underlining, bold printing, and a built-in carrying handle. The WPT-160 model offers advanced features including a 20 character LCD display, spell check with 80,000 word dictionary and 16,000 character text storage. This series is built to the industry’s highest quality standards at an unbeatable value.

The rugged and reliable AE-710 series office typewriters offer an extensive array of performance features, top of the line speed and the versatility to handle all typing requirements. Key features include automatic centering and return, fast 20cps print speed, 10 line/700 character correction memory, relocate, automatic underlining and bold printing. Their 15” carriage gives 11.5” of typing width and has a variable 10/12/15/PS pitch selection.

The AE-740 series office typewriters offer all the performance features of the AE-710 plus advanced features including a 40 character LCD display, 112,000 character text storage, right justification, stop codes, block functions, search and replace. You can easily type with confidence using the AE-740’s extensive editing features.

Nakajima electronic typewriters; increasing your typing efficiency through use of the most advanced technology!

Epoch *Manual Portable Typewriter*

ITEM NO.
ADLEPOCH

- 12.5" carriage
- 11.6" typing width
- 44 keys; 88 characters
- 1", 1.5", 2" line spacing
- 10 pitch; Pica 87 type style

- Paper support & release lever
- Margin set/release, tabulator
- Space bar, space repeater key
- 2 shift keys w/lock, backspace

\$279⁹⁹

- Carrying case with handle
- 90 day part, 1 yr labor warranty
- 12.5" x 13.5" x 4.9" / 9.25 lbs
- Uses: OLI7331525 ribbon
- Available in grey casing



ADLEPOCHSP (Spanish) **\$279.99**

SCRIPTOR *Portable Electronic Typewriter*

ITEM NO.
ADLSRIPTOR

\$349⁹⁹

- 13" carriage
- 9" print width
- Up to 12 cps
- 1", 1.5", 2" line spacing
- 10, 12, 15 pitch selections
- Full line correction memory

- Word and character erase
- Prestige Pica 10 included
- 1 year limited warranty
- 16" x 15" x 5" / 11 lbs
- OLI901250 ribbon, 900221 tape



SCRIPTOR II *Portable Electronic Typewriter*

ITEM NO.
ADLSRIPTORII

\$399⁹⁹

- 13" carriage
- 20 character display
- Up to 12 cps
- 80,000 word dictionary
- 10, 12, 15 pitch selections
- Full line correction memory

- 16,000 text memory
- Word and character erase
- Prestige Pica 10 included
- 1 year limited warranty
- 16" x 15" x 5" / 12 lbs
- OLI901250 ribbon, 900221 tape



WPT-150 *English Portable Electronic Typewriter*

ITEM NO.
NAKWPT150

\$332⁰⁰

- 13" carriage
- 9" print width
- Up to 12 cps
- 1", 1.5", 2" line spacing
- 10, 12, 15 pitch selections
- Full line correction memory

- Word and character erase
- Prestige Pica 10 included
- 1 year limited warranty
- 16" x 15" x 5" / 11 lbs
- Uses: XC001 or HYC01 ribbons
- NAKLO001 lift off tape



NAKWPT150S (Spanish) **\$332.00**
NAKWPT150RF **\$222.00**

WPT-160 *English Portable Electronic Typewriter*

ITEM NO.
NAKWPT160

\$499⁰⁰

- 13" carriage
- 20 character display
- Up to 12 cps
- 80,000 word dictionary
- 10, 12, 15 pitch selections
- Full line correction memory

- 16,000 text memory
- Word and character erase
- Prestige Pica 10 included
- 1 year limited warranty
- 16" x 15" x 5" / 12 lbs
- Uses: XC001 or HYC01 ribbons
- NAKLO001 lift off tape



NAKWPT160S (Spanish) **\$499.00**
NAKWPT160RF **\$330.00**

M&M Plain *42oz Resealable Bag Plain M&M's*

ITEM NO.
M&M PLN

\$15⁹⁵



M&M Peanut *42oz Resealable Bag Peanut M&M's*

ITEM NO.
M&M PNT

\$15⁹⁵



Add a Sweet Treat for that Special Customer!

REFURBISHED IBM TYPEWRITERS

•Ribbon, lift off tape, Prestige Elite 12 printwheel, batteries & manual included
 •90 day limited warranty

Wheelwriter 35RF *Refurbished Electronic Typewriter*

ITEM NO.
IBMWW35RF



•16.5" carriage
 •80 character display
 •Up to 20 cps
 •120,000 word dictionary

•10, 12, 15, PS pitch selections
 •4,000 character correction
 •60,000 text memory
 •Line, word & character erase

•Prestige Elite 12 included
 •21" x 18" x 8" / 28 lbs
 •GRCT340 ribbon, GRTC350 lift off

IBM Wheelwriters

<i>Model</i>	<i>Carriage</i>	<i>Display</i>	<i>CPS</i>	<i>Dictionary</i>	<i>Correct Mem</i>	<i>Text Mem</i>	<i>List</i>
Wheelwriter 1 RF	14.75"	No	16	50,000 word	Full Line	No	\$664.00
Wheelwriter 2 RF	14.75"	No	16	50,000 word	1,000	No	\$694.00
Wheelwriter 3 RF	16.5"	No	16	No	72	No	\$689.00
Wheelwriter 5 RF	16.5"	No	16	No	200	7,000	\$719.00
Wheelwriter 6 RF	16.5"	No	16	No	200	31,000	\$755.00
Wheelwriter 10 RF	16.5"	No	16	50,000 word	4,000	Reprint	\$699.00
Wheelwriter 15 RF	16.5"	No	20	50,000 word	6,000	Reprint	\$765.00
Wheelwriter 30 RF	16.5"	80 character	20	120,000 word	4,000	30,000	\$919.00
Wheelwriter 35 RF	16.5"	80 character	20	120,000 word	4,000	60,000	\$1,020.00
Wheelwriter 1000 RF	14.75"	No	16	50,000 word	6,000	Reprint	\$959.00
Wheelwriter 1500 RF	16.5"	No	20	50,000 word	6,000	10,000	\$1,020.00
Wheelwriter 2000 RF	14.75"	No	16	50,000 word	4,000	32,000	\$1,085.00
Wheelwriter 3000 RF	16.5"	No	20	50,000 word	4,000	48,000	\$1,135.00
Wheelwriter 3500 RF	16.5"	80 character	20	120,000 word	4,000	60,000	\$1,270.00

Call Your Sales Representative Today

Need Parts?

We Offer a Wide Variety of Typewriter Parts & Service!



KEYBOARDS

Product Number	Description	Cost
IBM1383200	Personal Wheelwriter keyboard	CFC
IBM1383809	Personal Wheelwriter 2 keyboard	CFC
IBM1384031	Wheelwriter 3 keyboard	CFC
IBM1384121	Wheelwriter 5 keyboard	CFC
IBM1384647	Wheelwriter 6 keyboard	CFC
IBM1384808	Wheelwriter 10 keyboard	CFC
IBM1400235	Wheelwriter 1000 keyboard	CFC
IBM1400500	Wheelwriter 1500 keyboard	CFC

BELTS

Product Number	Description	Cost
IBM1384812	Selectric drive belt	CFC
IBM1181018	Personal Size carrier belt	CFC
IBM1337651	Full size WW transport belt	CFC



ELEMENT

Product Number	Description	Cost
IBM1167xxx	Selectric II new element	CFC
IBM1167xxxU	Selectric II used element	CFC
IBM1352	Selectric III new element	CFC
IBM1352U	Selectric III used element	CFC

PLATENS

Product Number	Description	Cost
IBM1383247	Personal Wheelwriter platen	CFC
IBM1384049	Wheelwriter Series I platen	CFC
IBM1384809	Wheelwriter Series II platen	CFC



POWER SUPPLIES

Product Number	Description	Cost
IBM1383230	PWW1 White 9 Pin power supply	CFC
IBM1383441	PWW2 Black 9 pin power supply	CFC
IBM1384101	Series I Level 1 power supply	CFC
IBM1384285	Series I Level 2 power supply	CFC
IBM1400290	Series II University power supply	CFC
IBM1400362	PWW2 1000 8 Pin power supply	CFC



OTHER PARTS

Product Number	Description	Cost
IBM1384072	Wheelwriter Series I ribbon plate	CFC
IBM1384085	WW Series I carrier motor gear	CFC
IBM1393900	Wheelwriter hammer bumper	CFC
IBM1393901	Wheelwriter Series II solenoid	CFC
IBM1430156	Wheelwriter Series II erase table	CFC
IBM1430497	Wheelwriter Series I RH bail arm	CFC
IBM1430498	Black WW Series II RH bail arm	CFC
IBM1174427	Selectric tilt bellcrank	CFC
IBM1181049	Personal WWW erase table	CFC
IBM1205784	Selectric rebuilt transport pulley	CFC
IBM1206424	Selectric cardholder	CFC
IBM1280489	Selectric op cam	CFC
IBM1337055	Black WW paper release lever	CFC
IBM1337765	Genuine IBM WW correction tape	CFC
IBM1339074	Wheelwriter platen latch	CFC
IBM1339328	WW Series I hammer solenoid	CFC
IBM1342009	Wheelwriter 3 battery box	CFC
IBM1342178	Wheelwriter Series I erase table	CFC
IBM1353xxx	Wheelwriter Genuine printwheel	CFC
IBM1359563	Selectric ribbon lifter	CFC



MOTORS

Product Number	Description	Cost
IBM1384074	Wheelwriter Series I lift motor	CFC
IBM1384081	Wheelwriter Series I carrier motor	CFC
IBM1384823	WW Series II transport motor	CFC
IBM1384823N	WW Series II transport motor new	CFC
IBM1267789	Selectric III motor for lighted scale	CFC
IBM1267790	Selectric I and II motor	CFC



Printwheels

Adler Royal Printwheels

Compatibility - Adler/Royal: SE1005-1042/5005-5042, Sat II, Alpha Series Juki: 2100/2200/3100/3300/6000/6100/A/I

Item No	Description	OEM/Compatible	List
ADL772578	Elite Modern 10/12	OEM	\$21.95
RAR02ADL032	Herald Pica 10	Comp	\$38.95
RAR02ADL614	Herald Elite 10/12	Comp	\$38.95

Compatibility - Adler/Royal: Alpha 110-115/605-620/700D, Beta 220-225/8050-8200C, 900D, SE-305-325/405-425, Sat III/IV/V/VI, T-180, Meteor II
Olivetti: Gabriele 100/9009, IBM: Actionwriter I(6715)

Item No	Description	OEM/Compatible	List
ADL772298	Carol Courier 10/12	OEM	\$21.95
ADL772294	Helen Script 12	OEM	\$21.95

Brother Printwheels

Compatibility - All Brother daisywheel typewriters

Item No	Description	OEM/Compatible	List
RAR5402256	Prestige 10/12	Comp 402	\$39.95
RAR5402032	Script 10/12	Comp 405	\$39.95
RAR5402176	Eng Brougham 10	Comp 411	\$39.95

Canon Printwheels

Compatibility - AP100-850, S55-S86s, MX200-300, ES Series

Item No	Description	OEM/Compatible	List
RAR0504245	Courier 12	Comp 860140	\$38.95
RAR0504045	Courier 10	Comp 860150	\$38.95
RARCAN232	Prestige Pica 10	Comp 860160	\$38.95

IBM Printwheels

Compatibility - Wheelwriter

Item No	Description	OEM/Compatible	List
RAR1301033	Prestige Elite 12	Comp 1353502	\$52.00
RAR4901176	Courier 10	Comp 1353511	\$52.00
RAR1301512	Micro Mini Block 15	Comp 1353512-01	\$52.00
RAR1301226	Letter Gothic 12	Comp 1353514	\$52.00

Nakajima Printwheels

Compatibility - AE710/740/800/830, WPT150/160, Adler/Royal: Sat 40, Sat 80, Powerwriter, Powerwriter MD

Item No	Description	OEM/Compatible	List
NAKE032	Prestige Pica 10	OEM	\$29.50
NAKE033	Prestige Elite 12	OEM	\$29.50
NAKE045	Courier 10	OEM	\$29.50
NAKE101	Elite 12	OEM	\$29.50
NAKE224	Mini Gothic 15	OEM	\$29.50
NAKE225	Orator 10	OEM	\$29.50
NAKE245	Courier 12	OEM	\$29.50
NAKE226	Letter Gothic 10/12	OEM	\$29.50
NAKE608	Script 12	OEM	\$29.50
NAKE032SP	Spanish Prestige Pica 10	OEM	\$29.50

Smith Corona Printwheels

Compatibility- "K" Series

Item No	Description	OEM/Compatible	List
NAKE608	Script 12	Comp 22224	\$29.50
NAKE045	Courier 10	Comp 22220	\$29.50

Call Your Sales Representative Today

Nobody Enjoys Feeling Like They Have Been Left Out in the Cold



Superior Quality. Increased Profitability. Guaranteed.



**NOW
AVAILABLE!**
NXT Technical
Support Hotline
for Resellers &
End-users

NXT Premium is the NeXT Best Thing in Toner

Others keep telling you that buying and selling their recycled toner is to your advantage, but NXT Premium Replacement Cartridges are quality-tested, performance certified cartridges that offer a Lifetime Warranty.

- 100% lifetime warranty
- Certified performance (ISO/STMC)
- Reduce printing costs up to 50%
- High quality new components
- Expanded U.S. distribution

www.NXTpremium.com

Cash Registers

VENDOR/ MODEL	PRINTER TYPE RIBBON, INK ROLLER, THERMAL	DEPTS							CASH TILL			LIST PRICE		
		# STANDARD	# WHEN USING SHIFT	# EXPANDABLE TO	# OF CASHIERS	# OF PLU'S	# OF DISPLAYS	# OF TAX TABLES 1 OR 2 STATION PRINTER	PAPER WIDTH	# OF BILL BINS R- REMOVABLE	# OF COIN BINS R- REMOVABLE		OTHER	
ROYAL														
100CX	INK ROLLER	4	4	-	0	0	1	4	1	2.25" (58mm)	-	-	AC/DC operation	\$129.99
140DX	INK ROLLER	8	16	-	8	999	1	4	1	2.25" (58mm)	4	6R		\$169.99
410DX	THERMAL	24	24	-	10	2,000	1	4	1	2.25" (58mm)	4	4R		\$199.99
520DX	THERMAL	24	200	-	10	4,000	2	4	1	2.25" (58mm)	4	4-6R		\$199.99
A1100ML /A1100MLRF	THERMAL	16	200	-	40	7,000	2	4	1	2.25" (58mm)	4	5R	Optional Scanner	\$399.99
A2000ML	THERMAL	16	200	-	40	7,000	2	4	1	2.25" (58mm)	4	5R	Optional Scanner	\$499.99
A7000ML	THERMAL	16	200	-	40	10,000	2	4	2	2.25" (58mm)	4	5R	Optional Scanner	\$499.99
SAMSUNG														
ER-180U	THERMAL	16	-	-	10	500	1	4	1	2.25" (58mm)	4	4		\$249.00
ER-260EJ	THERMAL	16	-	-	99	8,500	2	4	1	2.25" (58mm)	5	5R	Service Dealers Only	\$532.00
ER-265EJ	THERMAL	16	-	-	99	8,500	2	4	1	2.25" (58mm)	5	5R	Service Dealers Only	\$532.00
ER-915	THERMAL	7	14	-	99	22,000	2	4	2	2.25" (58mm)	5R	5R	Service Dealers Only	\$749.00
ER-920	THERMAL	100	-	-	50	2,000	2	4	1	2.25" (58mm)	5R	5R	Service Dealers Only	\$715.00
ER-925	THERMAL	21	-	63	50	2,000	2	4	1	2.25" (58mm)	5R	5R	Service Dealers Only	\$749.00
ER-940	THERMAL	100	-	-	50	2,000	2	4	2	2.25" (58mm)	5R	5R	Service Dealers Only	\$782.00
ER-945	THERMAL	21	-	63	50	2,000	2	4	2	2.25" (58mm)	5R	5R	Service Dealers Only	\$799.00
NR-510	THERMAL	-	-	-	99	3,200	2	4	1	2.25" (58mm)	5R	5R	Service Dealers Only	\$615.00
NR-510R	THERMAL	-	-	-	99	3,200	2	4	1	2.25" (58mm)	5R	5R	Service Dealers Only	\$599.00
SHARP														
XE-A207	THERMAL	16	99	-	25	2,500	2	4	1	2.25" (58mm)	4R	5R		\$349.99
XE-A407	THERMAL	20	99	-	40	7,000	2	4	2	2.25" (58mm)	5R	6R		\$479.99

This information has been gathered from manufacturers' representatives and manufacturers' specification sheets and we have endeavored to be as accurate as possible. We apologize in advance for any errors or inaccurate information.

Call Your Sales Representative Today

Paper Rolls

ITEM CODE	ROLL W x L	CORE	DESCRIPTION	PACK	LIST
Bond Paper Rolls					
PRNNB5170	1.75" x 170'	7/16 "	1-Ply, 44mm	box/100	\$89.00
PRN9074-2235	2.25" x 150'	7/16 "	1-Ply, 57mm	box/100	\$77.95
PRN9074-2236	2.75" x 150'	7/16 "	1-Ply, 70mm	box/50	\$49.65
PRN9074-2238	3" x 150'	7/16 "	1-Ply, 76mm	box/50	\$52.38
PRN9074-2239	3" x 165'	7/16 "	1-Ply, 76mm	box/50	\$64.54
PRN9074-2240	3" x 190'	7/16 "	1-Ply, 76mm	box/50	\$72.63
Carbonless Bond Rolls					
PRN9077-0438	2.25" x 90'	7/16 "	2-Ply, white & canary	box/50	\$59.35
PRNN7100C	2.25" x 100'	7/16 "	2-Ply, white & canary	box/100	\$137.75
PRN9077-0047	3" x 90'	7/16 "	2-Ply, white & canary	box/50	\$84.78
PRN9077-0012	3" x 100'	7/16 "	2-Ply, white & canary	box/50	\$92.90
PRN9077-0439	3.25" x 90'	7/16 "	2-Ply, white & canary	box/50	\$90.46
PRN9077-0060	3" x 70'	7/16 "	3-Ply, white, canary & pink	box/50	\$98.40
Thermal Paper Rolls					
PRN9078-2980	1.75" x 220'	7/16 "	1-Ply thermal. 44mm	box/50	\$89.95
PRN9078-0567	2.25" x 50'	7/16 "	1-Ply thermal, 57mm	box/50	\$38.00
PRN9078-0076	2.25" x 85'	7/16 "	1-Ply thermal, 57mm	pk/3	\$4.96
PRN9078-0549	2.25" x 85'	7/16 "	1-Ply thermal, 57mm	box/50	\$43.00
PRN9078-0568	2.25" x 150'	7/16 "	1-Ply thermal, 57mm	box/50	\$87.15
PRN9078-2983	2.25" x 230'	7/16 "	1-Ply thermal, 57mm	box/50	\$122.90
PRN9078-3044	3.125" x 119'	7/16 "	1-Ply thermal. 80mm	box/50	\$85.65
PRN9078-5087	3.125" x 200'	7/16 "	1-Ply thermal. 80mm	box/50	\$122.25
PRN9078-0668	3.125" x 220'	7/16 "	1-Ply thermal. 80mm	box/50	\$129.55
PRN9078-0565	3.125" x 230'	7/16 "	1-Ply thermal. 80mm	box/50	\$117.85
PRN9078-0566	3.125" x 273'	7/16 "	1-Ply thermal. 80mm	box/50	\$140.88



100CX *Portable Ink Roller Cash Register*

ITEM NO.
ADL100CX

\$129⁹⁹



- Ideal for indoor/outdoor vendors
- 4 departments
- 4 tax tables / front display
- Receipt or journal tape
- Optional battery operation
- (4) "C" or included adapter

- (3) "AA" memory backup
- Cash drawer sold separately
- 90 day limited warranty
- 11.5" x 8.5" x 4.8" / 4 lbs
- CIMIR40 roller, 9074-2235 paper
- ADLMB30 cash drawer

ADLMB30 (Cash drawer) **\$129.99**

140DX *Ink Roller Cash Register*

ITEM NO.
ADL140DX

\$169⁹⁹



- 8 depts / 16 with shift
- 999 PLUs / 4 tax tables
- 8 clerks / front display
- 4 bill / 4 to 6 coin drawer
- Removable coin tray
- Automatic tax computation

- Receipt or journal tape
- Take up spool not included
- (3) "AA" memory backup
- 90 day limited warranty
- 13.5" x 14.3" x 9.3" / 10 lbs
- CIMIR40 roller, 9074-2235 paper

410DX *Thermal Cash Register*

ITEM NO.
ADL410DX

\$199⁹⁹



- Up to 24 departments
- 2,000 PLUs / 4 tax tables
- 10 clerks / dual displays
- 4 bill / 4 coin drawer insert
- Receipt or journal tape
- Customized logo printing

- Electronic journal
- Management reporting
- (2) "AA" memory backup
- 90 day labor, 1 yr part warranty
- 14.5" x 14" x 9" / 9.4 lbs
- Uses: 9078-0076 paper

520DX *Thermal Cash Register*

ITEM NO.
ADL520DX

\$199⁹⁹



- Up to 24 departments
- 4,000 PLUs / 4 tax tables
- 10 clerks / dual displays
- 4 bill / 4-6 coin trays
- Locking cash drawer
- Antibacterial key tops
- Receipt or journal tape

- Custom message printing
- Management reporting
- (2) "AA" memory backup
- Made from recycled plastics
- 90 day labor, 1 yr part warranty
- 13.5 x 14.25" x 9" / 11 lbs
- Uses: 9078-0076 paper

A1100ML *Thermal Cash Register*

ITEM NO.
ADLA1100ML

\$399⁹⁹



- 16 depts / 200 with shift
- 7,000 PLUs / 4 tax tables
- 40 clerks / dual displays
- 4 bill / 5 coin drawer
- Removable coin tray
- Custom scrolling messages
- Receipt or journal tape

- Electronic journal
- Serial port, SD card slot
- Integrated credit card capable
- 90 day labor, 1 yr part warranty
- 13" x 17" x 12" / 19 lbs
- Uses: 9078-0076 paper
- PS700LSR optional scanner

ADLA1100MLRF **\$399.99**

A2000ML *Thermal Cash Register*

ITEM NO.
ADLA2000ML

\$399⁹⁹



- 200 departments
- 7,000 PLUs / 4 tax tables
- 40 clerks / dual displays
- 4 bill / 5 coin drawer
- Antibacterial key tops
- Custom scrolling messages
- Receipt or journal tape
- Electronic journal

- Serial port, SD card slot
- Age verify, management reports
- (2) "AA" memory backup
- 90 day labor, 1 yr part warranty
- 16.5" x 12.75" x 11.75" / 20 lbs
- Uses: 9078-0076 paper
- PS700LSR optional scanner

A7000ML *Thermal Cash Register*

ITEM NO.
ADLA7000ML

\$499⁹⁹



- 16 depts / 200 with shift
- 10,000 PLUs / 4 tax tables
- 40 clerks / dual displays
- 4 bill / 5 coin drawer
- Removable coin tray

- Custom scrolling messages
- Receipt and journal tapes
- Electronic journal
- Serial port, SD card slot
- Integrated credit card capable

- 90 day labor, 1 yr part warranty
- 13" x 17" x 12" / 19 lbs
- Uses: 9078-0076 paper
- PS700LSR optional scanner

Call Your Sales Representative Today

ER-180U Thermal Cash Register

ITEM NO.
CRSER180U

\$249⁰⁰

- 16 departments
- 500 PLUs / 4 tax tables
- 10 clerks / dual displays
- 4 bill / 4 coin drawer
- Quick journal review
- Receipt or journal tape

- Electronic journal
- Receipt message printing
- 24 hour charge for memory
- 90 day limited warranty
- 13" x 17" x 8" / 8 lbs
- Uses: PRN9078-0076 paper rolls



ER-260EJ Thermal Cash Register

**Servicing Dealers Only*

ITEM NO.
CRSER260EJ

\$532⁰⁰

- 16 departments
- 8,500 PLUs / 4 tax tables
- 99 clerks / dual displays
- 5 bill / 5 coin drawer
- Removable till
- Spill proof flat keyboard
- Receipt tape; electronic journal

- Logo printing; quick review
- 3 Serial ports and SD slot
- Integrated credit capable
- 90 day limited warranty
- 15.8" x 17.8" x 9.8" / 25 lbs
- Uses: PRN9078-0076 paper rolls



CRSER265EJ (Flat keyboard) **\$532.00**

ER-915 Commercial Grade Thermal Cash Register

**Servicing Dealers Only*

ITEM NO.
CRSER915

\$749⁰⁰

- 7 to 14 depts / fast 22 lpm
- Up to 22,000 PLUs / 4 tax tables
- Up to 99 clerks / dual displays
- 5 bill / 5-6 coin locking drawer
- Removable till / two media slots
- Receipt and journal tape
- Electronic journal

- Pre / post custom logo printing
- Up to 4 Serial ports / SD slot
- Semi-integrated credit capable
- 90-day limited warranty
- 16.5" x 16.5" x 11.4" / 30.5 lbs
- Uses: PRN9078-0076 paper rolls



ER-920 Food Service/Retail Thermal Cash Register

**Servicing Dealers Only*

ITEM NO.
CRSER920

\$715⁰⁰

- 100 departments
- 2,000 PLUs / 4 tax tables
- 50 clerks / dual displays
- 5 bill / 5 coin drawer
- Removable till
- Spill proof flat keyboard
- Receipt or journal tape

- Logo printing; quick review
- 2 Serial ports and SD slot
- Integrated credit capable
- 90 day limited warranty
- 16" x 18" x 12" / 25 lbs
- Uses: PRN9078-0076 paper rolls



CRSER925 (Raised keyboard) **\$749.00**

ER-945 Food Service/Retail Thermal Cash Register

**Servicing Dealers Only*

ITEM NO.
CRSER945

\$799⁰⁰

- 21 depts / expandable to 63+
- 2,000 PLUs / 4 tax tables
- 50 clerks / dual displays
- 5 bill / 5 coin drawer
- Removable till
- Receipt and journal tapes

- Logo printing; quick review
- 2 Serial ports and SD slot
- Integrated credit capable
- 90 day limited warranty
- 16" x 18" x 12" / 26 lbs
- Uses: PRN9078-0076 paper rolls



NR-510 Commercial Grade Thermal Cash Register

**Servicing Dealers Only*

ITEM NO.
CRSNR510

\$615⁰⁰

- 90 flat keys / fast 15 lpm
- Up to 3,200 PLUs / 4 tax tables
- Up to 99 clerks / dual displays
- 5 bill / 5-6 coin locking drawer
- Removable till / two media slots
- Receipt or journal tape
- Electronic journal

- Pre / post custom logo printing
- 3 Serial ports / 1 USB / SD slot
- Semi-integrated credit capable
- 90-day limited warranty
- 16.5" x 16" x 11.4" / 28 lbs
- Uses: PRN9078-0076 paper rolls



CRSNR510R (Raised keyboard) **\$599.00**

BTP-S80 Compact Thermal Receipt Printer

ITEM NO.
CRS132098

\$235⁰⁰

- Compact space-saving design
- Intuitive keypad programming
- Up to 9.8" per second print speed
- Easy drop-in paper loading
- Paper end / near-end sensor
- Selectable part/full auto cut
- Top or front paper exit
- Prints coupons, graphic logos

- Programmable alarm volume
- Works with most POS software
- Supports Asian character sets
- USB, Serial, Ethernet, drawer port
- Windows / Linux compatible
- 2 year limited warranty
- 5.25" x 5" x 5" / 3.25 lbs
- Use: 3-1/8" or 2-1/4" paper rolls



Gcube Compact Thermal Receipt Printer

ITEM NO.
CRS131046

\$249⁰⁰

- Compact space-saving design
- Spill-proof cabinet covers cables
- Fast, up to 66 lines per second
- Easy drop-in paper loading
- Paper end, cover open LEDs
- Jam-free guillotine style cutter
- Top or front paper exit
- Prints coupons, graphic logos

- Stores up to 255 images
- Works with most POS software
- USB, Serial, Ethernet, drawer port
- Android device NFC function
- Windows / Mac compatible
- 4.8" x 4.8" x 4.8" / 2 lbs
- Use: 3-1/8" or 2-1/4" paper rolls



Giant 100 Compact Thermal Receipt Printer

ITEM NO.
CRS131045

\$245⁰⁰



- Compact solid design
- Mono or two-color capable
- Jam-Free operation
- Drop-in loading, end sensor
- LED indicators & feed button
- Prints coupons, graphic logos
- QR, watermark & barcodes

- Guillotine auto paper cutter
- Cash drawer connector
- USB, Serial, Ethernet ports
- Windows compatible
- 3 year limited warranty
- 5" x 6" x 5.25" / 4.2 lbs

BTP-R180ii Thermal Receipt Printer

ITEM NO.
CRS132085

\$199⁰⁰



- High print speed, reliable
- Mono, grayscale or two-color
- Easy drop-in paper loading
- Selectable part/full auto cut
- Accepts 5 paper widths
- Paper end / near-end sensor
- Watermark, barcode printing

- Cash drawer connector
- USB, Serial, Ethernet ports
- Windows compatible
- 3 year limited warranty
- 5.8" x 7.7" x 5.6" / 7 lbs

BTP-R880-NPV Ethernet Thermal Receipt Printer

ITEM NO.
CRS132040NPV

\$299⁰⁰



- Low noise, high print speed
- Mono, grayscale or two-color
- Simple keypad programming
- Drop-in loading, auto cutter
- Adjustable buzzer volume
- Stores & prints logo images
- Watermark, barcode printing

- Paper save feature, end sensor
- Cash drawer connector
- USB, Serial, Ethernet interfaces
- Windows & Mac compatible
- 3 year limited warranty
- 5.8" x 7.6" x 5.7" / 7 lbs

CRS132040SERNPV (Serial, USB) **\$299.99**

BTP-M300 Impact Receipt Printer

ITEM NO.
CRS132081

\$355⁰⁰



- POS, bar, kitchen applications
- Black/red printing / 4.7 lps
- Easy drop-in paper loading
- Accommodates 4 paper widths
- Prints coupons, graphic logos
- Paper end / near-end sensor
- Automatic paper cutter

- Cash drawer connector
- Integrated power supply
- Serial, USB interfaces
- Windows compatible
- 3 year limited warranty
- 6.3" x 9.5" x 6" / 9 lbs

CRS132082 (Parallel, USB) **\$355.00**
CRS132081-E (Ethernet only)..... **\$422.00**

Ellix 40 Thermal Receipt Printer

ITEM NO.
CRS131040

\$350⁰⁰



- Durable and quiet operation
- Unique LCD guides set-up
- Displays errors & messages
- Anti-jam technology
- Mono or two-color capable
- Drop-in loading, end sensor
- Prints coupons, graphic logos

- QR, watermark & barcodes
- Guillotine auto paper cutter
- Serial, USB interfaces
- Windows compatible
- 3 year limited warranty
- 5.6" x 7.6" x 5.4" / 7 lbs

ML700 Customer Display Screen

ITEM NO.
CRS503011

\$282⁰⁰



- 7" graphic LCD display
- Customize height 5.5" to 20"
- Promote products and specials
- Order accuracy reduces fraud
- Slide show feature, built-in clock
- Portrait or landscape view

- Easy set-up and port access
- Accepts ESC/POS commands
- Drag & drop or flashdrive
- Serial, USB interfaces
- 1 year limited warranty
- 7" x 1.5" x 4.6" / 2.2 lbs

Call Your Sales Representative Today

Model 6 Manual Push Cash Drawer

ITEM NO.
CRS160006

\$119⁰⁰



- Push drawer front open/close
- Metal housing and drawer
- Steel side rails, Nylon rollers
- 5 bill / 9 adjustable coin slots
- Spring activated bill weights
- Two 4" beveled media slots

- Large storage area under till
- 2 position / 3 function lock
- Black powder coat finish
- 1 year limited warranty
- 16" x 16.4" x 3.9" / 15 lbs

Model 13 Electronic Opening POS Cash Drawer

ITEM NO.
CRS160013

\$96⁰⁰



- Engineered for reliability
- Metal housing and drawer
- Steel side rails, Nylon rollers
- Enforced drawer compulsion
- 4 bill / 5 adjustable coin slots
- Hardened steel wire weights
- Two media slots, storage area

- 3 position / 4 function lock
- POS printer interface / 24V
- 29" cable, RJ12 connector
- Black powder coat finish
- 1 year limited warranty
- 14" x 15.8" x 4.13" / 13 lbs

Model 14 Electronic Opening POS Cash Drawer

ITEM NO.
CRS160014

\$106⁰⁰



- Engineered for reliability
- Metal housing and drawer
- Steel side rails, Nylon rollers
- Enforced drawer compulsion
- 4 bill / 5 adjustable coin slots
- Hardened steel wire weights
- Two media slots, storage area

- 3 position / 4 function lock
- POS printer interface / 24V
- 39" cable, RJ12 connector
- Black powder coat finish
- 1 year limited warranty
- 14" x 15.8" x 4.13" / 13 lbs

Model 16 Electronic Opening POS Cash Drawer

ITEM NO.
CRS160016

\$115⁰⁰



- Engineered for reliability
- Metal housing and drawer
- Steel side rails, Nylon rollers
- Enforced drawer compulsion
- 5 bill / 5 coin slots
- Adjust Hardened wire weights
- Media slot, storage area

- 3 position / 4 function lock
- POS printer interface / 24V
- 80" cable, RJ12 connector
- Black powder coat finish
- 1 year limited warranty
- 16.5" x 16.38" x 4.5" / 19 lbs

Model 18 Electronic Opening POS Cash Drawer

ITEM NO.
CRS160018

\$210⁰⁰



- Engineered for reliability
- Metal housing and drawer
- Steel side rails, Nylon rollers
- Enforced drawer compulsion
- 5 bill / 5 coin slots
- Hardened steel wire weights
- Two media slots, storage area

- 3 position / 4 function lock
- POS printer interface / 24V
- 80" cable, RJ12 connector
- Black powder coat finish
- 1 year limited warranty
- 18" x 16.63" x 4.4" / 24 lbs

Model 60 Electronic Opening ECR Cash Drawer

ITEM NO.
CRS160160

\$135⁰⁰



- Engineered for reliability
- Metal housing and drawer
- Steel side rails, Nylon rollers
- Enforced drawer compulsion
- 5 bill / 6 adjustable coin slots
- Hardened steel wire weights
- Two 4" beveled media slots

- Large storage area under till
- 3 position / 4 function lock
- SAM4s ECR Comp Connectors
- Black powder coat finish
- 1 year limited warranty
- 16.5" x 15.8" x 4.4" / 16 lbs

CRS160360 (POS cash Drawer) **\$135.00**

XE-A207 Thermal Cash Register w/Multi-Line Display

ITEM NO.
SHRXA207

\$349⁹⁹



- 16 depts / 99 with shift
- 2,500 PLUs / 4 tax tables
- 25 clerks / dual displays
- 4 bill / 5 coin drawer
- Removable till
- Currency conversion
- Electronic journal
- Logo printing on receipt
- Serial port and SD slot
- (2) "AA" memory backup
- 90 day labor, 1 yr part warranty
- 13.6" x 15.6" x 12.6" / 24 lbs
- Uses: 9078-0076/ 9078-2983 paper

XE-A407 Thermal Cash Register w/Multi-Line Display

ITEM NO.
SHRXA407

\$479⁹⁹



- 20 depts / 99 with shift
- 7,000 PLUs / 4 tax tables
- 40 clerks / dual displays
- 5 bill / 6 coin drawer
- Removable till
- Currency conversion
- Receipt and journal tapes
- Customized logo printing
- Serial port and SD slot
- (2) "AA" memory backup
- 90 day labor, 1 yr part warranty
- 16.7" x 15.6" x 12.6" / 25 lbs
- Uses: 9078-0076/ 9078-2983 paper

CASH MANAGEMENT/COUNTERS

AccuBANKER USA

3030 Counterfeit Money Detector Pen

ITEM NO.
ACU3030

\$4⁹⁹



- Easy to use
- No training required
- Just draw on bill
- Amber line indicates real
- Black line means it is suspect
- Use with other detection methods for best results

LED420 Counterfeit Money Detector

ITEM NO.
ACULED420

\$79⁹⁹



- Simple electric operation
- Automatic on/off sensor
- Portable compact design
- Detects fake bills, CC or ID cards
- LED UV, White LED detection
- UV and watermark detection
- Integrated ruler
- 3 year limited warranty
- 8.5" x 5.7" x 4.5" / 3 lbs

LED430 4-Way Counterfeit Detector

ITEM NO.
ACULED430

\$99⁹⁹



- Simple electric operation
- Automatic on/off sensor
- Portable compact design
- Detects fake bills, CC or ID cards
- LED UV, White LED detection
- UV and watermark detection
- Sensor for Magnetic detection
- Micro-print magnifier lens
- Integrated ruler
- 3 year limited warranty
- 8.5" x 5.7" x 4.5" / 3 lbs

D450 Bleached Bill Auto Detector

ITEM NO.
ACUD450

\$164⁰⁰



- Easy plug-in & use operation
- Automatic feeding system
- Compact size fits anywhere
- Fast one second verification
- UV, Magnetic & IR detection
- Watermark detection sensor
- Rejects bleached bills
- Pass or fail indicators
- Industrial strength motor
- 3 year limited warranty
- 5" x 5.5" x 2.8" / 1 lb
- Uses: ACUDETCLNKIT

D500 Super Dollar Authenticator

ITEM NO.
ACUD500

\$228⁰⁰



- Auto load, front or rear exit
- Compact size fits anywhere
- Multiple currency detection
- Immediate note verification
- UV, Magnetic & IR detection
- Watermark detection sensor
- Rejects bleached bills
- Automatic addition function
- Audible and visual alarm
- Industrial strength motor
- 3 year limited warranty
- 5" x 6" x 3" / 1 lb
- Uses: ACUDETCLNKIT

D585 Multi-Scanix Counterfeit Detector

ITEM NO.
ACUD585

\$360⁰⁰



- High resolution LCD display
- Automatic feeding system
- Immediate verification
- USD, EUR, GBP currencies
- UV, MG, WM & IR detection
- Image, spectrum, length
- Audible and visible alarm
- On screen reporting
- Easy software updates
- 3 year limited warranty
- 5.4" x 4.9" x 3" / 1.3 lbs

Call Your Sales Representative Today

AB1100 Plus Commercial Cash Counter

ITEM NO.
ACUAB1100

- High resolution LCD display
- External display included
- Automatic or manual start
- 200 bills back-loading hopper
- Counts up to 1,500 bills/minute
- Emergency stop feature

ACUAB1100UV (UV detection) **\$490.00**
ACUAB1100MGUV (MG & UV detection) **\$520.00**

\$416⁰⁰

- Roller friction feeding system
- Industrial strength motor
- 3 year limited warranty
- 9.8" x 11" x 6" / 16 lbs



AB4200 Bank Grade Bill Counter

ITEM NO.
ACUAB4200

\$499⁰⁰

- High resolution LCD display
- Auxiliary external display
- Tactile hard key control panel
- 300 bills front-loading hopper
- Counts 1200, 1500 & 1800 bpm
- Add function auto grand totals
- Customizable batch selection
- Audible and visual alerts
- Emergency stop button
- 3 year limited warranty
- 10.8" x 10" x 9.8" / 13.2 lbs

ACUAB4200UV **\$518.00**
ACUAB4200MGUV **\$545.00**



AB5200 Plus Electric Bank Teller Counter

ITEM NO.
ACUAB5200

\$609⁰⁰

- Advanced currency counter
- Large flat panel display
- Detachable external display
- Front-load feed mechanism
- Variable counting speeds
- 600, 1000, 1,200 & 1,900 bpm
- UV & Magnetic detection
- Built-in dimension detector
- Computerized batching
- Audible and visual alerts
- Quick stop & dust cover
- 3 year limited warranty
- 10.7" x 9.9" x 9.6" / 14.5 lbs



AB5800 Value Extension Counter

ITEM NO.
ACUAB5800

\$629⁰⁰

- High resolution LCD display
- USD or EURO denominations
- Cotton or Polymer banknotes
- 200 bills front-loading feeder
- Adjustable counting speeds
- 600, 900, 1,200 & 1,600 bpm
- UV & Magnetic detection
- Detailed counting report
- Number of bills/denomination
- Cumulative total add mode
- Audible and visual alerts
- 3 year limited warranty
- 10.8" x 9.5" x 9.3" / 14 lbs



\$6500 Quick Mixed Bill Counter

ITEM NO.
ACUS6500

\$1,179⁰⁰

- High resolution full TFT display
- Up to 5 currencies detection
- Mixed denomination counting
- 200 bills back-loading hopper
- Counts up to 1,000 bills/minute
- Detailed Report w/Serial numbers
- UV, MG, IR, DD, DB & MT detection
- Dual Contact Image Sensor
- Easy software update
- 1 year limited warranty
- 9.84" x 13.4" x 11.4" / 13.7 lbs



AB7100 Mixed Bill Value Counter

ITEM NO.
ACUAB7100

\$1,865⁰⁰

- High resolution color display
- Mix, sort, local & count modes
- USD denominations only
- 800 bills front-loading hopper
- UV, MG, IR & size detection
- Counts up to 1,200 bills/minute
- Detailed counting report
- Roller friction feeding system
- SD, USB, serial interfaces
- 3 year limited warranty
- 11.4" x 11.2" x 9.9" / 16 lbs



AB7500 Mixed Bill Value Counter

ITEM NO.
ACUAB7500

\$2,709⁰⁰

- High resolution color display
- Mix, sort, count & orientation
- USD or EURO denominations
- 800 bills front-loading hopper
- UV, MG, IR, & MT detection
- Counts up to 1,000 bills/minute
- Reject tray for nonstop count
- Detailed counting report
- Roller friction feeding system
- SD, USB, Ethernet interfaces
- 3 year limited warranty
- 13" x 12.44" x 13" / 33 lbs



FSW112A Assorted Coin Wrappers

ITEM NO.
RSIFSW112A

\$9⁴⁹



- 112 sturdy assorted wrappers
- Penny, Nickel, Dime, Quarter
- 28 of each denomination
- High quality kraft paper
- Preformed and color coded

- Crimped end for easy filling
- Marked with dollar value
- Federal Reserve compliant

RSIRSW112P (112 penny wrappers) **\$9.49**
RSIRSW112Q (112 quarter wrappers) **\$9.49**

FSW504A 504 Assorted Wrappers

ITEM NO.
RSIFSW504A

\$24⁹⁹



- 504 sturdy assorted wrappers
- Penny, Nickel, Dime, Quarter
- 126 of each denomination
- High quality kraft paper

- Preformed and color coded
- Crimped end for easy filling
- Marked with dollar value
- Federal Reserve compliant

RSIFSW504P (504 penny wrappers) **\$24.99**
RSIFSW504Q (504 quarter wrappers) **\$24.99**

RSW360A 360 Assorted Wrappers

ITEM NO.
RSIRSW360A

\$19⁹⁹



- 360 sturdy assorted wrappers
- Penny, Nickel, Dime, Quarter
- 90 of each denomination
- High quality kraft paper

- Preformed and color coded
- Crimped end for easy filling
- Marked with dollar value
- Federal Reserve compliant

FSW1008A 1008 Assorted Wrappers

ITEM NO.
RSIFSW1008A

\$34⁹⁹



- 1008 sturdy assorted wrappers
- Penny, Nickel, Dime, Quarter
- 252 of each denomination
- High quality kraft paper

- Preformed and color coded
- Crimped end for easy filling
- Marked with dollar value
- Federal Reserve compliant

RSIFSW1008P (1,008 penny wrappers) **\$34.99**
RSIFSW1008Q (1,008 quarter wrappers) **\$34.99**

RSCB-100 Compact Cash Box

ITEM NO.
RSIRSCB100

\$24⁹⁹



- Ideal for home, office or school
- Cash or key box
- 1 bill / 3 coin removable tray
- 10 Built in key hooks
- Solid steel construction

- Security lock
- Recessed carrying handle
- 90 Day Warranty
- 8" w x 6.5" d x 3.5" h / 1 lb

RSCB-200 Full-Size Cash Box

ITEM NO.
RSIRSCB200

\$34⁹⁹



- Ideal for home, office or school
- 1 bill / 5 coin removable tray
- Extra storage under tray
- Solid steel construction
- Security lock

- Recessed carrying handle
- 90 Day Warranty
- 9.8" w x 7.4" d x 3.9" h / 1 lb

RSCB-300 Deluxe Cash Box

ITEM NO.
RSIRSCB300

\$45⁹⁹



- Ideal for home, office or school
- 4 spring loaded bill compartment
- 9 coin removable tray
- Extra storage under tray
- Separate media slot

- Solid steel construction
- Security lock
- Recessed carrying handle
- 90 Day Warranty
- 11.8" w x 9.5" d x 3.7" h / 2 lbs

RSCB-400 Tiered Tray Cash Box

ITEM NO.
RSIRSCB400

\$59⁹⁹



- Ideal for home, office or school
- 4 spring loaded bill compartment
- 5 coin tiered tray
- Check/receipt compartment
- Solid steel construction

- Security lock
- Recessed carrying handle
- 90 Day Warranty
- 11.8" w x 9.5" d x 4" h / 2 lbs

DCB-175B One Row Coin Sorter

ITEM NO.
RSIDCB175B

\$37⁹⁹



- Simple flip switch operation
- Lightweight, portable design
- One row per denomination
- 75 coins hopper capacity
- Sorts up to 120 coins/minute

- Straight to wrapper feature
- Easy open top cover
- 1 year limited warranty
- 5.7" x 5.9" x 8.3" / 1.25 lbs
- Uses: Two C batteries

DCB-275D Digital One Row Coin Sorter

ITEM NO.
RSIDCB-75D

\$59⁹⁹



- Simple electric operation
- Digital display shows total
- Lightweight, compact, portable
- One row per denomination
- 75 coins hopper capacity
- Sorts up to 120 coins/minute

- Straight to wrapper feature
- Easy open top cover
- 1 year limited warranty
- 5.7" x 5.9" x 8.2" / 1.25 lbs

QS-2N One Row Coin Sorter

ITEM NO.
RSIQS1

\$59⁹⁹



- Lightweight, portable design
- One row per denomination
- 200 coins hopper capacity
- Sorts up to 156 coins/minute
- No power or batteries needed

- Manual crank operation
- Easy close dust-free door
- 1 year limited warranty
- 9" x 7" x 8" / 3 lbs
- FSW112A or RSW360A wrappers

QS-1AC One Row Coin Sorter

ITEM NO.
RSIQS1AC

\$79⁹⁹



- Simple automatic coin sorting
- Lightweight, portable design
- One row per denomination
- 200 coins hopper capacity
- Sorts up to 156 coins/minute

- Anti-jam technology
- Removable lid, overflow tray
- 1 year limited warranty
- 6.8" x 10.8" x 8.5" / 3.8 lbs
- FSW112A or RSW360A wrappers

CO-1000N One Row Coin Sorter

ITEM NO.
RSICO1000N

\$99⁹⁹



- Easy electric operation
- Portable, lightweight design
- One row per denomination
- 300 coins hopper capacity
- Sorts up to 240 coins/minute

- Anti-jam technology
- 1 year limited warranty
- 7" x 11" x 9" / 4 lbs
- FSW504A or FSW1008A wrappers

FS-2N Digital Coin Sorter

ITEM NO.
RSIFS2N

\$164⁹⁹



- Hands-free electric operation
- Two rows per denomination
- Displays count and dollar value
- 400 coins hopper capacity
- Sorts up to 312 coins/minute

- Anti-jam technology
- 1 year limited warranty
- 7" x 8.4" x 9" / 5.5 lbs
- FSW504A or FSW1008A wrappers

FS-44N Digital Coin Sorter

ITEM NO.
RSIFS44N

\$249⁹⁹



- High performance operation
- Four rows per denomination
- Displays count and dollar value
- 800 coins hopper capacity

- Sorts up to 312 coins/minute
- Coin chute guide, removable lid
- Automatic row advancement
- Anti-jam technology

- Thermal printer available
- Serial port print connection
- 1 year limited warranty
- 7.7" x 13.4" x 10" / 7.9 lbs

RCD-1805-RS Counterfeit Pens

ITEM NO.
RSIRCD1805RS

\$12⁹⁹



- Easy to Use
- Instant Verification
- Yellow mark means pass
- Black mark means it is suspect
- Works on all US and most international currency
- Five pens per pack

RSIRCD1812RS (12 pack)**\$24.99**

RCD-UIVP Handheld Counterfeit Detector

ITEM NO.
RSIRCDUIVP

\$17⁹⁹



- Protect self from financial loss!
- Pocket-size portable design
- Ultraviolet counterfeit sensor
- Security strip currency guide
- Easily detects fake currency
- Identify holographic images
- Great for IDs, passports & CCs
- Battery operated (2) CR2032
- 1 year parts & labor warranty
- 2.6" w x 0.6" d x 4.5" h / 2 oz

RCD-1500 Ultraviolet Counterfeit Detector

ITEM NO.
RSIRCD1500

\$34⁹⁹



- Lightweight, portable design
- Fast and simple verification
- Easy electric operation
- Detects strips, dots, markings
- Bills, passports, credit cards, ID
- Includes UV detection guide
- U.S. security thread chart
- 1 year limited warranty
- 8.3" x 4.7" x 4.8" / 103 lbs
- Uses: RSIUVB-2PK bulbs

RCD-3000 4-Way Counterfeit Detector

ITEM NO.
RSIRCD3000

\$69⁹⁹



- Compact and portable design
- Fast, easy electric operation
- Detects fake bills & ID cards
- Multi-level detection process
- Ultraviolet strip detection
- Magnetic ink sensor
- Watermark fluorescent light
- Micro-print magnifying lens
- U.S. security detection guide
- 1 year limited warranty
- 7.9" x 4.25" x 4.5" / 1.2 lbs

RCD-3120 Quick Scan Counterfeit Detector

ITEM NO.
RSIRCD3120

\$159⁹⁹



- Compact design fits anywhere
- Built-in bright LED display
- Easy half second scan time
- 4-way orientation acceptance
- Multi-level detection process
- Ultraviolet, magnetic ink, infrared
- Paper quality, size & thickness
- Total bill and total value count
- Instant pass / fail results
- 1 year limited warranty
- 7.3" x 6.5" x 5.3"

RCD-BG1 5-Phase Counterfeit Detector

ITEM NO.
RSIRDBG1

\$219⁹⁹



- High-quality bank grade
- Compact, portable design
- Built-in bright LED display
- Easy half second scan time
- 4-way orientation acceptance
- Roller tech reduces errors
- Fluorescent, magnetic, infrared
- Paper quality, size & thickness
- Total bill and total value count
- Instant pass / fail results
- Free software updates
- 1 year limited warranty
- 5.6" x 5" x 2.95" / 1.4 lbs

RTP-2 Compact Thermal Receipt Printer

ITEM NO.
RSIRTP2

\$129⁹⁹



- Make record keeping easy!
- For coin sorters & bill counters
- Compact space-saving design
- Coin or dollar value count
- Provide printed receipt
- Time and date stamped
- 3.9" per second print speed
- 384 dots per line
- Count for each denomination
- Value, sum and grand total
- LED status indicators
- Low noise operation
- Easy drop-in paper loading
- Top, front paper exit
- 1 year limited warranty
- 4.8" x 6.2" x 3.6" / 1 lb
- Use: 2.25" paper rolls

Call Your Sales Representative Today

RBC-ES250 *Electric Cash Counter*

ITEM NO.
RSIRBCES250

\$279⁹⁹



- External display system
- Multi-angle views of bill count
- Convenient automatic start
- 200 bills back-loading hopper
- Counts up to 1,400 bills/minute
- UV, Magnetic & IR detection

- Cumulative total add mode
- Batch option (1 - 999 bills)
- Retractable carry handle
- 1 year limited warranty
- 10.2" x 12.2" x 7" / 10.6 lbs

RBC-EG100 *High Speed Cash Counter*

ITEM NO.
RSIRBCEG100

\$299⁹⁹



- Multi-view external display
- LCD display & 16-button panel
- Auto start, stop & self-test
- Front-loading 500 bills hopper
- Up to 1,500 bills/minute
- UV, MG and IR detection

- Add mode with total count
- Value count by denomination
- Retractable carrying handle
- 1 year limited warranty
- 12.6" x 11.8" x 11.8" / 12.6 lbs

RBC-ED350 *High Speed Cash Counter*

ITEM NO.
RSIRBCED350

\$329⁹⁹



- Flat panel with LCD display
- Auto start / stop operation
- 500 bills front-loading hopper
- Variable speed 900-1,500 bpm
- UV, MG, IR and DD detection
- Batch option (1-999 bills)

- Add mode with total count
- Value count by denomination
- Retractable carrying handle
- 1 year limited warranty
- 10" x 10.4" x 8.2" / 9.9 lbs

RBC-ED200 *High Speed Cash Counter*

ITEM NO.
RSIRBCED200

\$379⁹⁹



- Quick and accurate counting
- LCD display & 9-button panel
- Auto start, stop & self-test
- Front-loading 500 bills hopper
- Counts up to 1,500 bills/minute
- UV, Magnetic & IR detection

- Cumulative add mode
- Batch option (1-999 bills)
- Retractable carrying handle
- 1 year limited warranty
- 10.6" x 9.8" x 9.7" / 12 lbs

RBC-ED250 *High Speed Cash Counter*

ITEM NO.
RSIRBCED250

\$429⁹⁹



- External display system
- Multi-angle view of bill count
- Flat keyboard control panel
- Convenient automatic start
- Front-loading 500 bills hopper
- Counts up to 1,500 bills/minute

- UV, Magnetic & IR detection
- Batch option (1-999 bills)
- Add mode with total count
- Value count by denomination
- Retractable carrying handle
- 1 year limited warranty
- 10" x 9" x 8.75" / 11.5 lbs

EBC-1000 *Elite One Pocket Discriminator*

ITEM NO.
RSIEBC1000

\$799⁹⁹



- Bank grade commercial quality
- Large, easy to read LCD
- 3 modes (mix, sort, count)
- Front-loading 500 bills hopper
- Mixed denomination mode
- 4 country currency detection

- Up to 1,200 bills/minute
- UV, MG, IR and DD detection
- Count total by denomination
- Easy bill batching and adding
- 1 year limited warranty
- 10.6" x 9.7" x 9.6" / 10.6 lbs

RBC-EP1600 *One Pocket Discriminator*

ITEM NO.
RSIRBCEP1600

\$1,349⁹⁹



- Bank grade commercial quality
- Large, easy to read LCD
- 3 modes (mix, sort, count)
- Front-loading 600 bills hopper

- Mixed denomination mode
- 12 country currency detection
- Up to 1,500 bills/minute
- UV, MG, IR and CIS detection

- Count total by denomination
- Easy bill batching and adding
- 1 year limited warranty
- 10" x 10.6" x 11" / 13.2 lbs

SLD-16 *Economic Counterfeit Detector*

ITEM NO.
RIBSLD16

\$49⁹⁹



- Large detecting area
- Easy electric operation
- Lightweight compact design
- Ideal for retail market use
- Detects fake bills or ID cards

- Ultraviolet counterfeit detection
- 1 year limited warranty
- 11.7" x 5.4" x 5.4" / 1 lb

BC-2000 *Electric Currency Counter*

ITEM NO.
RIBBC2000

\$440⁰⁰



- Count & batch LED displays
- Flat keypad control panel
- Batch and count displays
- 500 note back-loading hopper
- Counts 800, 1,100 & 1,500 bpm
- Automatic size detection

- Continuous & batch modes
- Retractable carry handle
- 1 year limited warranty
- 11" x 9" x 9.8" / 15.4 lbs

RIBBC2000UV/MG.....529.00

BC-2000V *Electric Currency Counter*

ITEM NO.
RIBBC2000V/UV/MG

\$639⁰⁰



- Large matrix LCD screen
- Flat keypad control panel
- Batch and count displays
- 500 note adjustable hopper
- Counts 800, 1,100 & 1,500 bpm
- UV & MG counterfeit detection
- Automatic size detection

- Accumulation counting
- Continuous & batch modes
- Retractable carry handle
- 1 year limited warranty
- 11" x 9" x 9.8" / 15.4 lbs

BCS-160 *Electric Currency Counter*

ITEM NO.
RIBBCS160

\$2,055⁰⁰



- Compact size fits anywhere
- Multi-currencies capability
- 3.5" LCD display
- 500 note hopper
- Counts 800, 1,000 & 1,200 bpm
- UV, Magnetic & IR detection

- Read & print serial number
- Easy software updates
- USB and LAN ports
- 1 year limited warranty

CS-10S *Electric Coin Counter*

ITEM NO.
RIBCS10S

\$655⁰⁰



- Easy electric operation
- Portable, lightweight design
- 1,500 coins hopper capacity
- Counts up to 1,800 coins/minute
- Thickness & diameter settings
- International coins & tokens

- Continuous and preset modes
- 7 digit LCD count display
- Four coin tubes included
- 1 year limited warranty

CS-2000 *Electric Coin Counter*

ITEM NO.
RIBCS2000

\$680⁰⁰



- High performance operation
- One denomination per batch
- Coin type & memory settings
- 9,000 coins hopper capacity
- Counts up to 2,300 coins/minute
- Continuous counting mode

- Accumulative total add mode
- Batch counting mode
- Bright 6 digit digital display
- 1 year limited warranty
- 14.3" x 10.6" x 9.3" / 26.5 lbs

HCS-3300 *High Speed Coin Counter*

ITEM NO.
RIBHCS3300

\$690⁰⁰



- Designed for heavy duty use
- Independent start/stop key
- 7 digit LED data display
- 12,000 coins hopper capacity
- Counts up to 2,300 coins/minute
- Continuous or batch counting
- Accumulation counting mode

- Counted number memory save
- Cotton bags for coin collection
- 1 year limited warranty
- 14.3" x 10.6" x 12.9" / 24 lbs

CS-610S+ *Coin Counter and Sorter*

ITEM NO.
RIBCS610S+

\$2,040⁰⁰



- Highest counting accuracy
- Alloy sensor technology
- Foreign coin detect & reject
- LCD display operation panel
- 3,600 coins hopper capacity
- Counts up to 600 coins/minute
- Mixed & batch counting modes

- 6 denominations, 33 currencies
- Software updates via USB port
- Durable steel construction
- Easy clean tilt sorting rail
- 1 year limited warranty
- 20" x 11" x 12.6" / 35.3 lbs

Call Your Sales Representative Today



S-3 Single Sheet Check Signer

ITEM NO.
WIDS3

\$1,260⁰⁰



- Instantaneous trip
- 1-7/8" x 1-7/8" engraving area
- Four direction plate mount
- Adjustable guide

- Removable die holder
- Rugged metal case
- Visual counter
- Two-key security system

- Signature plates available
- 1 year limited warranty
- 6" x 10" x 7" / 16 lbs
- Uses: WID1000P ribbon

MAX

CASH MANAGEMENT/CHECK WRITERS

EC-30A Electronic Check Writer

ITEM NO.
MXBEC30A

\$299⁰⁰



- Automatic feed system
- 10 digit LCD display
- 10 digit + symbols printing
- Prints original plus 2 copies
- 1-7/8" throat depth
- Deep, dark embossing

- Repeat print; clear key
- No signature plates available
- 90 day labor, 1 yr part warranty
- 4" x 9" x 4" / 3 lbs
- Uses: MXBIR50 black ink roller

EC-70 Accumulating Check Writer w/Counter

ITEM NO.
MXBEC70

\$398⁰⁰



- Automatic feed system
- 14 digit LCD display
- 14 digit + symbols printing
- Prints original plus 2 copies
- 3-1/8" throat depth
- Deep, dark embossing
- Repeat print; clear key

- Totals number of checks
- Totals dollar amounts
- No signature plates available
- 90 day labor, 1 yr part warranty
- 8" x 10" x 4" / 4 lbs
- Uses: MXBIR50 black ink roller



CASH MANAGEMENT/CHECK WRITER

9000-8RF Refurbished Manual Check Writer

ITEM NO.
PAY90008RF

\$599⁰⁰



- Pull lever action
- 8 column, 2 color printing
- Accepts personal/business sizes
- Accepts multiple copy checks

- 3" throat depth
- Deeply serrated typeface
- Large verification window
- One-key security system

- 30 day limited warranty
- 10" x 14" x 11" / 15 lbs
- Uses: PAY90008R ribbon

Paymaster Accessories

Item Code	Description	Fits Model	List
PAY8000R	Black Nylon Ink Ribbon	8000	\$52.50
PAY8500R	Black/Red Nylon Ink Ribbon	8500-7, 8500-9	\$55.65
PAY90008R	Black Nylon Ink Ribbon	9012 Series, 9000-8	\$52.50
PAY90009R	Black/Red Nylon Ink Ribbon	9000-9	\$52.50

HL10 Phone Handset Lifter

ITEM NO.
PLNHL10

\$85⁰⁰



- Lifts/returns handset to cradle
- One-touch call answering
- Compatible w/most desk phones

- Works with wireless headsets
- 1 year limited warranty

Blackwire 3215 Corded Headset

ITEM NO.
PLN209746-101

\$99⁰⁰



- Voice, music & multimedia
- Monoaural over-the-head design
- Leatherette-encased speaker
- Noise canceling microphone
- Flexible microphone boom
- Digital Signal Processing

- Volume, mute, answer/end
- Dynamic EQ, UC Toolkit
- Folds flat for portability
- USB-A & 3.5mm connectivity
- 1 year limited warranty

S11 Headset System

ITEM NO.
PLNS11

\$99⁰⁰



- Hands-free convenience
- Monoaural over-the-head design
- Noise canceling microphone
- Easy access controls on base
- Volume, mute, Call answer/end
- Separate fine-tune tone control

- Single & multi-line compatible
- Headset stand reduces clutter
- 1 year limited warranty
- Includes: amplifier

S12 Headset System

ITEM NO.
PLNS12

\$135⁰⁰



- Hands-free w/superior clarity
- 2-in-1 convertible design
- Noise canceling microphone
- Firefly™ in-use light indicator
- Easy access controls on base
- Volume, mute, headset on/off

- Single & multi-line compatible
- Convenient headset stand
- 1 year limited warranty
- Includes: amplifier

HW540 EncorePro Headset

ITEM NO.
PLN88828-01

\$129⁰⁰



- Superior comfort & reliability
- Versatile, convertible design
- Over-the-head or ear style
- Monoaural fit for either ear

- Noise canceling microphone
- 3' cord w/Quick Disconnect™
- Amplifier for phone required
- 2 year limited warranty

HW261N SupraPlus Wideband Headset

ITEM NO.
PLN64339-31

\$199⁰⁰



- Business reliability & comfort
- Binaural over-the-head design
- Lightweight with flexible cable
- Foam cushions, comfort T-Pad
- Noise canceling microphone

- Bendable click-stop boom
- For wideband systems only
- 3' cord w/Quick Disconnect™
- Adjustable clothing clip
- Amplifier for phone required

Voyager 4210 Wireless Headset

ITEM NO.
PLN211317-101

\$189⁰⁰



- Ergonomic comfort design
- Up to 98' roaming range
- Up to 12 hours of talk time
- Monoaural over-the-head design
- Noise canceling microphone
- Flexible microphone boom

- Auto music play/on, pause/off
- Volume, mute, answer/end
- SoundGuard technology
- Certified Skype for Business
- USB-A & Bluetooth connectivity
- 1 year limited warranty

Voyager 4220 Wireless Headset

ITEM NO.
PLN211996-101

\$199⁰⁰



- Listen to music or take calls
- Superior stereo audio
- Binaural over-the-head design
- Up to 98' roaming range
- Up to 12 hours of talk time
- 2 Noise canceling microphone

- Flexible microphone boom
- SoundGuard protection
- Enhanced voice alerts
- USB-A & Bluetooth connectivity
- 2 year limited warranty

Call Your Sales Representative Today

M22 Vista Amplifier

ITEM NO.
PLNM22

\$129⁰⁰



- Clearline audio technology
- Volume and mute controls
- Switch from headset to handset
- Easy single-button toggle
- 10' cord w/Quick Disconnect™

- Single & multi-line compatible
- 2 "AA" batteries included
- 2 year limited warranty

MX10 Vista Universal Amplifier

ITEM NO.
PLNMX10

\$159⁰⁰



- Multi-media compatible
- Phone, PC or audio devices
- Controls headset sound
- Switch from headset to handset

- Easy single button toggle
- Quick Disconnect™
- Single & multi-line compatible
- 1 year limited warranty

CT14 Wireless Headset Phone

ITEM NO.
PLNCT14

\$169⁰⁰



- DECT 6.0, backlit LCD
- Call waiting / caller ID
- 70 directories
- 300' range from base
- 10 hours talk time, voicemail
- Mute, redial, volume control

- Convertible monaural headset
- Noise canceling microphone
- 1 year limited warranty
- 5" x 4" x 7" / 1 lb
- Expandable to 5 stations

Savi8240 Wireless Headset

ITEM NO.
PLN211200-01

\$279⁰⁰



- Crystal clear voice call clarity
- DECT technology, 590' range
- Secure, private conversation
- Up to 7 hours of talk time
- Convertible 3-in-1 design

- Noise canceling microphone
- Volume, mute, answer/end
- SoundGuard technology
- USB (Windows / Mac)
- 1 year limited warranty

CS540 Wireless Headset System

ITEM NO.
PLNCS540

\$319⁰⁰



- Crystal clear voice call clarity
- DECT technology / 350' range
- Up to 7 hours of talk time
- Convertible 2-in-1 design
- Noise canceling microphone
- Plug-and-talk installation

- Smart power management
- Elegant docking station
- Replaceable gel eartips
- Uses: HL10 handset lifter
- 1 year limited warranty

Savi7220 Wireless Stereo Headset

ITEM NO.
PLN213020-01

\$319⁰⁰



- Business reliability & comfort
- Binaural over-the-head design
- DECT technology, 400' range
- Conference up to 3 headsets
- Up to 12 hours of talk time

- Noise canceling microphone
- Flexible microphone boom
- Anti-startle sound elimination
- SoundGuard protection
- 2 year limited warranty

CS520 Wireless Headset System

ITEM NO.
PLNCS520

\$349⁰⁰



- Lightweight quality audio
- DECT technology / 350' range
- Up to 9 hours of talk time
- Plug-and-talk installation
- Binaural headband design

- Noise canceling microphone
- Conference up to 3 headsets
- Elegant docking station
- Uses: HL10 handset lifter
- 1 year limited warranty

SaviW740 Wireless Headset System

ITEM NO.
PLN83542-01

\$579⁰⁰



- Multi-device wireless system
- PC, desk and mobile phones
- DECT technology, 350' range
- Digital Signal Processing
- Conference up to 3 headsets
- Audio transfer capability

- Up to 7 hours of talk time
- Convertible 3-in-1 design
- Noise canceling microphone
- Volume, mute, answer/end
- SoundGuard technology
- 1 year limited warranty

TTB500 *ATR480 Calculating Time Clock*

ITEM NO.
ACPTTB500

\$250⁰⁰



- Automatic total of payroll hrs
- Auto top-feed and alignment
- Two-color print, security lock
- 50 employee capacity
- Selectable date & time format
- Built-in programmable buzzer
- Supports all pay periods
- Automatic daylight savings

- Power failure protection
- Table or wall mount
- 2 year limited warranty
- Bundle includes: ATR480 clock, 300 time cards, three red/black ribbons, two 10-pocket expanding racks and four case keys**

BTR150 *BioTouch Biometric Time Clock*

ITEM NO.
ACPBTR150

\$279⁰⁰



- Brilliantly simple time tracking
- Ideal for remote offices, no net
- Bright LCD display and keypad
- Fingerprint, Prox or PIN entry
- Eliminates buddy punching
- Fully self-contained solution
- No software or cables needed!
- Clock rules for up to 5 shifts
- Accommodate up to 500 users

- USB flash drive data transfer
- View and edit in Excel format
- Supports all pay periods
- 2 year limited warranty
- 6" x 2" x 5" / 1 lb
- Bundle includes: BTR150 clock, USB memory stick and 15 RFID proximity badges**

TRB750 *ES700 Multifunction Time Recorder*

ITEM NO.
ACPTRB750

\$329⁰⁰



- Time and attendance recording
- Document control, job costing
- Date, time, weekday LCD display
- Bright LED alignment window
- Auto, semi or manual activation
- User selectable format, font size
- Right or left margin, 1 color print
- 13 preset messages, 4 languages
- Synchronizes w/US atomic clock

- Four digit password protection
- Supports all pay periods
- Automatic daylight saving
- Power failure protection
- 2 year limited warranty
- Bundle includes: ES700 clock, 50 time cards, two black ribbons and a 10-pocket expanding rack**

TRB950 *ES900 Advanced 3-in-1 Time Recorder*

ITEM NO.
ACPTRB950

\$349⁰⁰



- Payroll, job cost, time recording
- Doc stamp, numbering machine
- LCD display, alignment window
- Auto, semi, manual, combo action
- Right or left side 1 color printing
- Adjustable margin and font size
- I-Mark print for irregular punches
- 13 preset messages, 6 languages
- 300+ custom print configurations
- 1-8 sequential numbers, 9 repeats

- Synchronizes w/US atomic clock
- Four digit password protection
- Accepts onionskin to thick stock
- Auto daylight saving change
- Built-in battery back-up
- 2 year limited warranty
- Bundle includes: ES900 clock, 50 time cards, two black ribbons and a 10-pocket expanding rack**

150AR3 *Heavy Duty Time Recorder*

ITEM NO.
ACP150AR3

\$440⁰⁰



- Classic analog clock dial face
- Ideal for harsh environments
- Insert card for automatic print
- Time & attendance, job costing
- Right margin, 1 or 2 color print
- Prints day, 1-12 hours & minutes
- Supports all pay periods

- Manual daylight saving change
- Tough, corrosion-proof case
- Tamper resistant key lock
- Tabletop or wall mountable
- 2 year limited warranty
- 9" x 7" x 10" / 10 lbs
- 762 or 352 cards, 106002 ribbon

ACP150NR4 (mth, dt, 1-12 hr, min).....**\$440.00**
ACP150QR4 (mth, dt, 0-23 hr, min).....**\$440.00**
ACP150RR4 (mth, dt, 0-23 hr, hnd).....**\$440.00**

ES1000 *Atomic Totalizing Payroll Recorder*

ITEM NO.
ACPES1000

\$578⁰⁰



- LCD displays day, date, time
- Automatic top-feed activation
- Easy edit 2 color printing
- Prints 1-12 or 0-23 hrs, min, hnd
- Synchronizes w/US atomic clock
- 100 employee capacity
- Supports all pay periods

- Accumulates reg/overtime hrs
- Automatic daylight savings
- 1 year limited warranty
- 7" x 5" x 9" / 5 lbs
- ES1010 cards, 1000R ribbon

Call Your Sales Representative Today

OLB300 ProPunch Biometric Time Clock

ITEM NO.
ACPOLB300

\$450⁰⁰



- Complete web based system
- Multi-purpose Ethernet terminal
- LCD display and keypad
- Fingerprint, Prox or PIN entry
- Eliminates buddy punching

- Powerful software for 50 users
- Employee capacity upgrades
- Multi-level user permissions
- Review, edit, process payroll
- Anywhere, anytime access

- 2 year limited warranty
- 6" x 2" x 5" / 3 lbs
- Bundle includes: OLB300 clock, software & 30 proximity badges

TXP300 Time Clock Accessory Pack

ITEM NO.
ACPTXP300



\$115⁰⁰

- For: ATR480 and TTB500 clock models
- 300 Weekly/Bi-weekly 2-sided time cards
- 3 Red/Black replacement ribbons
- Authentic Acroprint brand supplies

EXP250 Time Clock Accessory Pack

ITEM NO.
ACPEXP250



\$47⁰⁰

- For: ES700, ES900, TRB750, TRB950 models
- 250 side-print weekly time cards
- 2 black replacement ribbons
- Authentic Acroprint brand supplies

EXP500 Time Clock Accessory Pack

ITEM NO.
ACPEXP500



\$77⁰⁰

- For: ES700, ES900, TRB750, TRB950 models
- 500 side-print weekly time cards
- 3 black replacement ribbons
- Authentic Acroprint brand supplies

ACROPRINT ACCESSORIES

Item Code	Item Description	Fits Model	List
ACPATR481	50pk Wkly/Bi-Wkly/Monthly Time Cards	ATR480, TTB500	\$11.00
ACPATR122R	Red/Black Clock Ribbon	ATR480, TTB500	\$22.00
ACP352	1000pk Bi-Weekly Time Cards	ES700, ES900, TRB750, TRB950, 150 Series	\$46.00
ACP390121	Black Clock Ribbon	ES700, ES900, TRB750, TRB950	\$17.50
ACP762	1000pk Weekly Time Cards	150 Series	\$46.00
ACP106002	Blue Clock Ribbon	150 Series	\$14.00
ACP106008	Red/Blue Clock Ribbon	150 Series	\$14.00
ACPES1010	100pk Daily Time Cards	ES1000	\$15.50
ACP1000R	Red/Black Clock Ribbon	ES1000	\$17.50
ACPATR241	250pk Wkly/Bi-Wkly Time Cards	ATR240, ATR360	\$15.50
ACPATR242	Red/Black Clock Ribbon	ATR240, ATR360	\$22.00
ACP137000	Purple Clock Ribbon	ET, ETC	\$16.00
ACPPROXBADGE	15pk RFID Proximity Badges	BioTouch, ProPunch, BTR150, OLB300	\$49.99
ACP81-0121-000	10 Slot Expandable Card Rack	ES1000, ATR480, TTB500	\$18.00
ACPM120R	25 Slot Expandable Card Rack	ES1000, ATR480, TTB500	\$32.00
ACP118	25 Slot Expandable Card Rack	ES700, ES900, TRB750, TRB950, 150 Series	\$32.00
ACP175	25 Slot Metal Card Rack	ES700, ES900, TRB750, TRB950, 150 Series	\$49.95

PIX-25 *Electronic Time Clock and Stamp*

ITEM NO.
AMAPIX25

\$362⁰⁰



- LCD display, alignment window
- Automatic or manual activation
- Right or left margin, 1 color print
- Prints year, month, date, time
- Synchronizes w/US atomic clock
- Precision quartz accuracy
- Ribbon ink capacity indicator
- Automatic daylight savings
- 3 year memory protection
- Table or wall mount
- 1 year limited warranty
- 5.5" x 6.5" x 6" / 4 lbs
- 5200, 1790 cards, 315151 ribbon

BX-1500 *Electronic Time Recorder*

ITEM NO.
AMABX1500

\$377⁰⁰



- Large analog clock face
- Top loading feed and eject
- Across the card, 1 color print
- Prints day or date and time
- Surface detection function
- Precision quartz accuracy
- Supports all pay periods
- Automatic daylight savings
- 3 year memory protection
- 1 year limited warranty
- 9" x 8" x 4" / 5 lbs
- 550350, 552550 or 556950 cards
- 319250 ribbon, 2546S rack

PIX-200 *Atomic Time Clock and Date Stamp*

ITEM NO.
AMAPIX200

\$438⁰⁰



- Large date, time LCD display
- Illuminated alignment window
- Right or left margin, 1 color print
- Prints year, month, day and time
- Synchronizes w/US atomic clock
- 31 selectable preset formats
- 13 comments, 6 languages
- Automatic daylight savings
- Consecutive numbering
- Security password, key lock
- 1 year limited warranty
- 6" x 6" x 7" / 5 lbs
- 5200, 1790 cards, 315151 ribbon

TCX-21 *Electronic Time Clock*

ITEM NO.
AMATCX21

\$464⁰⁰



- Clock dial, digital date display
- Illuminated alignment window
- Auto or manual 1 color print
- Prints year, month, date, time
- Precision quartz accuracy
- Secure key cover lock
- Automatic daylight savings
- Power failure protection
- Table or wall mount
- 1 year limited warranty
- 7" x 6" x 8" / 7 lbs
- 5200, 1790 cards, 315151 ribbon

EX-3500N *Electronic Time Clock*

ITEM NO.
AMAEX3500N

\$528⁰⁰



- Easy to read analog clock face
- Automatic top loading feed
- Easy edit 2 color printing
- Prints day or date and time
- Surface detection function
- Built-in signal device
- Supports all pay periods
- Automatic daylight savings
- 3 year memory protection
- 1 year limited warranty
- 7.5" x 9" x 5" / 5 lbs
- 550350, 552550 or 556950 cards
- 315251 ribbon, 2546S rack

PIX-3000x *Electronic Time Recorder and Stamp*

ITEM NO.
AMAPIX3000X

\$655⁰⁰



- LCD display, alignment window
- Automatic or manual activation
- Right or left margin, 1 color print
- Prints year, month, date, time
- Selectable imprint formats
- Consecutive numbering
- Alphanumeric programming
- Quartz clock accuracy
- Automatic daylight savings
- 3 year memory protection
- Table or wall mount
- 1 year limited warranty
- 5.9" x 6" x 6.9" / 6 lbs
- 5200, 1790 cards, 315151 ribbon

MRX-35 *Electronic Calculating Time Clock*

ITEM NO.
AMAMRX35

\$674⁰⁰



- Large backlit LCD display
- Easily programmed w/cards
- Accumulates reg/overtime hrs
- Prints day or date and time
- 50 employee capacity
- Supports wkly/bi-wkly periods
- Automatic daylight savings
- Power failure protection
- Table or wall mount
- 1 year limited warranty
- 7" x 4.5" x 9" / 6 lbs
- 101300 cards, 319250 ribbon

4700 *Automatic Time and Date Stamp*

ITEM NO.
AMA4700

\$895⁰⁰



- Traditional clock dial display
- Monitor, record and validate
- Automatic 1 color printing
- Prints year, month, date, time
- Adjustable trigger alignment
- Accepts media up to 1/4" thick
- 5 carbon copy print capable
- Custom text plates available
- Tamper-proof key lock
- 1 year limited warranty
- 5.5" x 10" x 6" / 13 lbs
- Uses: 8400BK ribbon

Call Your Sales Representative Today

MTX-30P Time Guardian Proximity Automated Clock System

ITEM NO.

AMAMTX30P

\$515⁰⁰



- Keypad and LCD display
- Proximity swipe or PIN entry
- Auto data polling, time synch
- Interfaces w/payroll systems
- 100 employee capacity
- Unlimited employee upgrade
- Supports all pay periods
- Multi-depts, policies, holidays

- Tracks and reports wages, tips
- Plug and play set-up Wizard
- Power failure protection
- 1 year limited warranty
- 6.5" x 1.8" x 5.4" / 1.3 lbs
- Software, 50' USB, 6' Cat5, 20 Proximity badges included

AMAMTX30PW (WiFi version) **\$551.00**

MTX-30-FW WiFi Biometric Time Clock

ITEM NO.

AMAMTX30FW

\$627⁰⁰



- Color TFT display
- Fingerprint or PIN entry
- Eliminates "buddy punching"
- Up to 100 employees
- Supports all pay periods
- Tracks and reports wages,

- tips and bonuses
- ADP, QuickBooks, Paychex
- USB flash drive data transfer
- WiFi, Ethernet
- 1 year limited warranty
- 5.4" x 6.5" x 1.8" / 1.3 lbs

AMAMTX30F (USB version) **\$599.00**

AFR-100 Time Guardian Facial Recognition System

ITEM NO.

AMAAFR100

\$638⁰⁰



- User friendly interface
- Face, Prox or Pin entry
- Eliminates buddy punching
- Realtime communications
- Interfaces w/payroll systems
- Supports all pay periods
- Multi-depts, policies, holidays

- Auto calculates reg/ot hours
- View, edit, report, export data
- USB flash drive data transfer
- 8 management reports
- Ethernet or WiFi

AMAAFR200 (w/Fingerprint package) **\$915.00**

MJR-7000 Computerized Calculating Time Clock

ITEM NO.

AMAMJR7000

\$1,447⁰⁰



- Keypad and LCD display
- Accumulates reg/overtime hrs
- Across the card, 1 color print
- Prints date, day and time
- 100 employee capacity
- Concise attendance reports
- Supports all pay periods

- Automatic daylight savings
- Power failure protection
- Table or wall mount
- 1 year limited warranty
- 9.5" x 8" x 13.5" / 17 lbs
- 099000 cards, 872304 ribbon

AMANO ACCESSORIES

Item Code	Item Description	Fits Model	List
AMA520050	250/pk Weekly Cards	PIX-25, 200, 3000x, TCX-21	\$16.00
AMA520250	250/pk BI-Weekly Cards	PIX-25, 200, 3000x, TCX-21	\$16.00
AMA179050	250/pk Semi-Monthly Cards	PIX-25, 200, 3000x, TCX-21	\$14.50
AMA5200	1000/pk Weekly Cards	PIX-25, 200, 3000x, TCX-21	\$40.00
AMA5200-2	1000/pk BI-Weekly Cards	PIX-25, 200, 3000x, TCX-21	\$42.00
AMA1790	1000/pk Semi-Monthly Cards	PIX-25, 200, 3000x, TCX-21	\$44.00
AMA315151	Black Ink Ribbon	PIX-25, 200, 3000x, TCX-21	\$18.95
AMA629671	Red Ink Ribbon	PIX-25, 200, 3000x, TCX-21	\$18.95
AMA2546S	25 Pocket Card Rack	PIX, TCX, BX, EX series	\$35.00
AMA552550	250/pk Weekly Cards	BX-1500, EX-3500n	\$13.50
AMA556950	250/pk BI-Weekly Cards	BX-1500, EX-3500n	\$13.50
AMA550350	250/pk Monthly/Semi-Monthly Cards	BX-1500, EX-3500n	\$13.50
AMA319250	Black Ink Ribbon	BX-1500, MRX-35	\$18.95
AMA315251	Black/Red Ink Ribbon	EX-3500n	\$18.95
AMA8400BK	Black Ink Ribbon	4700	\$20.00
AMA099000	1000/pk Employee Count Cards (0-99)	MJR-7000	\$56.00
AMA872304	Blue Ink Ribbon	MJR-7000	\$22.00
AMAAMX-307800	20/pk Proximity Badges	MTX-30	\$54.00

400E-KIT *Electronic Time Clock*

ITEM NO.
LTH400E-KIT

\$250⁰⁰



- Backlit blue LCD display
- Automatic top-feed
- Prints day, month, date
- 1-12 or 0-23 hrs, min, hnd
- In, out and lunch punch
- SmartClock™ technology
- Perpetual calander

- Automatic daylight savings
- 1 year limited warranty
- 8.4" x 7.4" x 4.8" / 3.4 lbs
- Includes: (200) E14 time cards, (2) 10 pocket card racks, (2) VIS6004 ribbons, (2) Keys

PC700-WEB *Touch Screen Time and Attendance System*

ITEM NO.
LTHPC700WEB

\$349⁰⁰



- Full color touch screen display
- Proximity badge or PIN entry
- View, edit, report, export info
- Interfaces w/payroll systems
- Transfer depts, enter amounts
- Text and audio messaging
- Relay for bell or access control

- Ethernet, WiFi
- 8 year battery backup
- 1 year limited warranty
- 4.8" x 1.5" x 8" / 1.5 lbs
- Requires subscription to PayClock Online software

1600E *Electronic Atomic Time Recorder*

ITEM NO.
LTH1600E

\$355⁰⁰



- Synchronizes w/US atomic clock
- LCD displays date and time
- Automatic or manual activation
- Right or left margin, 1 color print
- Prints year, date and time
- 13 preset messages
- 18 print formats, 4 languages

- Tru-Align™ for a perfect punch
- Automatic daylight savings
- Power failure protection
- 1 year limited warranty
- 6.3" x 7" x 5.7" / 4 lbs
- LTHE16-100 cards, VIS6008 ribbon

2100HD *Thermal Print Timeclock*

ITEM NO.
LTH2100HD

\$359⁰⁰



- Heavy-duty construction
- WhisperPrint™ technology
- No ribbon required
- High-contrast LCD display
- EZSet™ rotary knob
- Tru-Align printing system
- Six print formats

- Prints day, month, date
- 1-12 or 0-23 hrs, min, hnd
- 9.75" x 8" x 6" / 5.7 lbs
- 1 year limited warranty
- E8-100 time cards

LT5000 *Time, Date & Numbering Stamp*

ITEM NO.
LTHLT5000

\$455⁰⁰



- LED illuminated print window
- Single insertion 2-line printing
- Adjust R/L margin, 1 color print
- Custom text, 4 one-touch sets
- Online setup USB flash transfer
- 30 preset formats, 15 comments
- 8 digit adv/repeat numbering
- SmartClock functionality

- Automatic daylight savings
- 6 language options
- Key locking case w/pass code
- 3 year memory protection
- 1 year limited warranty
- 6.2" x 7" x 7" / 4 lbs
- LTHE time cards, VIS6008 ribbon

7500E *Atomic Calculating Time Recorder*

ITEM NO.
LTH7500E

\$599⁰⁰



- Backlit blue LCD display
- Automatic top-feed w/sensor
- Across the card, 1 color print
- Prints day or date and time
- Synchronizes w/US atomic clock
- 100 employee capacity
- Supports all pay periods

- Automatic daylight savings
- 3 language options
- 3 year memory protection
- 1 year limited warranty
- 6" x 5" x 8" / 3 lbs
- LTHE7 cards, VIS6008 ribbon

Call Your Sales Representative Today

25-9EX Time Card Rack

ITEM NO.
LTH259EX

\$38⁰⁰

- 25 card capacity
- Expandable plastic
- Accepts all 9" cards

•5" x 2" x 34" / 4 lbs
•Black



25-7EX Time Card Rack

ITEM NO.
LTH257EX

\$38⁰⁰

- 25 card capacity
- Expandable plastic
- Accepts all 7" cards

•4" x 2" x 27" / 3 lbs
•Black



LATHEM ACCESSORIES

<i>Item Code</i>	<i>Item Description</i>	<i>Fits Model or Series</i>	<i>List</i>
LTHVIS6004	Black/Red Clock Ribbon	400E	\$15.00
LTHE14-100	100/pk Universal Time Cards	400E	\$14.00
LTHE8-100	100/pk Weekly Time Cards	800P, 2100HD	\$14.00
LTHE8B	1000/pk Bi-Weekly Time Cards	800P, 2100HD	\$100.00
LTHE16-100	100/pk Weekly Time Cards	1600E	\$12.00
LTHE100	100/pk Weekly Time Cards	LT5000	\$12.00
LTHE	1000/pk Weekly Time Cards	LT5000	\$42.00
LTHE7	1000/pk All Pay Periods Time Cards	7500E	\$89.00
LTHVIS6007	Red Clock Ribbon	1600E, 7500E, LT5000	\$15.00
LTHVIS6008	Purple Clock Ribbon	1600E, 7500E, LT5000	\$15.00
LTHRFBADGE	ID Badges	PC600, PC700	\$45.00
LTHCH107	1000/pk Weekly Time Cards	2100/4000 Series	\$36.00
LTH1900L	1000/pk Weekly Time Cards	2100/4000 Series	\$36.00
LTH1900L2	1000/pk Bi-Wkly Time Cards	2100/4000 Series	\$39.00
LTH350	1000/pk Job Cards	2100/4000 Series	\$36.00
LTHL31	1000/pk Bi-Wkly Time Cards	2100/4000 Series	\$36.00
LTH72CN	Red/Blue Clock Ribbon	2100/4000 Series	\$12.60
LTH259EX	25 Pocket Card Rack	Fits all 9" time cards	\$38.00
LTH257EX	25 Pocket Card Rack	Fits all 7" time cards	\$38.00

2650 Pro Auto Aligning Time Clock

ITEM NO.
PTI2650PRO

\$370⁶⁰



- Date, time, weekday LCD display
- Top loading auto alignment feed
- Wrong card side detect and eject
- 6-column, 2-sided, 31-day cards
- Three in/out punch cycles per day
- Military or standard time format
- Across the card 1 color print
- Prints time and AM / PM
- Unlimited employee capacity
- Auto or manual shift option

- Supports all pay periods
- Automatic daylight savings
- Power failure protection
- Tamper proof security lock
- 1 year limited warranty
- 7.25" x 8.5" x 5" / 3 lbs
- Bundle includes: 2650Pro clock, 25 time cards, 1 black ribbon, and 2 security keys**

3500 Time Recorder and Stamp

ITEM NO.
PTI3500

\$336⁸⁰



- Large backlit LCD display
- Automatic one-hand activation
- Right or left hand, 1 color print
- Prints year, date and time
- 14 selectable message options
- English, Spanish or French
- Tamper-proof security lock

- Automatic daylight savings
- Power failure protection
- 1 year limited warranty
- 6.5" x 6.5" x 5.7" / 4 lbs
- Bundle includes: 3500 clock, 25 time cards, 1 black ribbon, and 2 security keys**

3600SS Time Clock & Document Stamp

ITEM NO.
PTI3600SS

\$408⁷⁵



- Date, day & time LCD display
- Smart Site™ alignment guide
- Auto punch right or left hand
- Single or multi-sheet thickness
- Prints year, date and time
- 14 selectable message options
- 2 lines of custom messaging
- No employee/pay period limit

- Automatic daylight savings
- Tamper-proof security lock
- Power failure protection
- 1 year limited warranty
- 6.3" x 6.8" x 6" / 3.5 lbs
- Bundle includes: 3600SS clock, 25 time cards, 1 black ribbon, and 2 security keys**

3700HD Heavy Duty Time Clock and Document Stamp

ITEM NO.
PTI3700HD

\$435⁹⁹



- Time and attendance recording
- Document control, job costing
- Date, time, weekday LCD display
- Industrial-grade steel construction
- Withstands harsh environments
- Side-loading print activation
- Right or left margin, 1 color print
- 14 preset messages, 3 languages
- Military or standard time format

- Unlimited employee capacity
- Automatic daylight savings
- Power failure protection
- Tamper proof security lock
- 1 year limited warranty
- 8.25" x 8" x 6.8" / 6.65 lbs
- Bundle includes: 3700HD clock, 25 time cards, 1 black ribbon, and 2 security keys**

4000Pro Auto Totaling Time Clock

ITEM NO.
PTI4000

\$543⁸⁹



- Auto feed, align and eject card
- Date, time, weekday LCD display
- Auto totaling of payroll hours
- Up to 50 employee capacity
- Round 0, 5, 10 or 15 min option
- Supports all pay periods
- Across the card 1 color print
- Prints date, punch in/out, totals
- Military or standard time format

- Automatic daylight savings
- Power failure protection
- Tamper resistant key lock
- 1 year limited warranty
- 7" x 7.25" x 6.5" / 3.25 lbs
- Bundle includes: 4000Pro clock, 25 time cards, 1 black ribbon, and 2 security keys**

TimeTrax Sync Analog Wireless Wall Clock

ITEM NO.
PTI9A13AG

\$161⁰⁰



- 13" round analog clock
- Low profile design
- Non-glare shatterproof lens
- White face with black frame
- Black Arial style numerals
- Standard 12 hr time format
- RF wireless synchronization

- Updates every 24 hrs at 2am
- Automatic daylight savings
- 3.6V lithium battery operated
- Anti-theft wall bracket
- 3 year limited warranty
- 13.25" x 13.25" x 2" / 3.05 lbs
- (RF transmitter sold separately)**

Call Your Sales Representative Today

Pyramid Time Trax Ethernet Time & Attendance System

- Date, time & name LCD display
- LAN network compatible
- Unlimited number of terminals
- Point & click edit and reporting

- Plug-and-play simplicity
- Supports all pay periods
- Interfaces w/payroll systems
- Windows, ADP, PayChex, Quickbooks

- Automatic daylight savings
- Power failure protection
- 1 yr warranty, 90 day software
- Software, cables, brackets included

Time Trax EZ Ethernet Swipe Card Time Clock System

ITEM NO.
PTITTEZEK

\$381⁴⁹



- Swipe card entry
- 50 employee start-up
- Upgradable to 500 employees

- Includes 50 swipe cards
- Uses: 41304 swipe cards
- 500-4, 500-12 or 500-24 racks

Time Trax EZ Prox Ethernet Proximity Time Clock System

ITEM NO.
PTIPDLAUBKN

\$381⁴⁹



- Proximity badge or fob entry
- 50 employee start-up
- Upgradable to 500 employees

- Includes: 15 proximity badges
- Uses: 42454 badges, 42468 fobs

Time Trax Prox Ethernet Proximity Time Clock System

ITEM NO.
PTITTPROXEK

\$490⁴⁵



- Badge, key fob or PIN entry
- 50 employee start-up
- Unlimited employees

- Includes: 15 proximity badges
- Uses: 42454 badges, 42468 fobs
- 500-4, 500-12 or 500-24 racks

Time Trax Elite Ethernet Biometric Time Clock System

ITEM NO.
PTITTELITEEK

\$653⁹⁹



- Fingerprint scan or PIN entry
- Eliminates buddy punching

- 50 employee start-up
- Unlimited employees

DIG-4B Independent Digital Clock

ITEM NO.
PTIDIG4B

\$252⁰⁰



- Ultra-bright red LED display
- Non-glare shatterproof lens
- Four extra-large 4" digits
- Sleek, low profile design
- Shows hour and minutes

- AM/PM or Military format
- PM indicator light
- Power outage auto reset
- Easy to read from up to 250'
- Wall or ceiling mountable

DIG-6B Atomic Time Recorder and Stamp

ITEM NO.
PTIDIG6B

\$274⁰⁰



- Black housing, 6' cord
- 1 year limited warranty
- 11.5" x 6" x 1.5" / 2.45 lbs

- PTIDIG6B**
Advanced Features-
- Six extra-large 4" digits
 - Shows hour, min, seconds
 - 15.5" x 6" x 1.5" / 3 lbs

5000+ Auto Totaling Time Clock

ITEM NO.
PTI5000

\$652⁹⁰



- Automatic total of payroll hrs
- Auto top-feed and alignment
- Across the card, 1 color print
- Prints month, date, day, time
- LCD display & security lock
- 100 employee capacity
- Supports all pay periods
- Rounded time options

- Automatic daylight savings
- Power failure protection
- 1 year limited warranty
- 7" x 6.5" x 7" / 4.5 lbs
- Bundle includes: 5000+ clock, 25 time cards, 1 black ribbon, and 2 security keys

5000+HD Heavy Duty Calculating Time Recorder

ITEM NO.
PTI5000HD

\$707⁴⁰



- Automatic total of payroll hrs
- Auto top-feed and alignment
- Across the card, 1 color print
- Prints month, date, day, time
- 100 employee capacity
- Rounded time options
- Heavy duty steel construction
- Ideal for harsh environments

- Tamper-proof security lock
- Automatic daylight savings
- Power failure protection
- 1 year limited warranty
- 8.75" x 7.5" x 7.25" / 7.5 lbs
- Bundle includes: 5000+HD clock, 25 time cards, 1 black ribbon, and 2 security keys

43029 Metal Key Rack

ITEM NO.
PTI43029

\$21⁸⁰



- Keep keys/fobs organized
- 9 hooks multi-functional hooks
- Durable steel construction
- Black powder coat finish

- Corrosion & scratch-resistant
- Easily mounts to wall or door
- 10" x 3" x 0.5" / 5.8 oz

43030 Metal Key Rack

ITEM NO.
PTI43030

\$27²⁵



- Industrial, commercial use
- Keep keys/fobs organized
- Accessible to 19 hooks
- Durable steel construction

- Black powder coat finish
- Temperature, moisture-proof
- Mount hardware included
- 20" x 3" x 0.5" / 11.5 oz

500-12 Employee Badge Rack

ITEM NO.
PTI50012

\$23⁹⁸



- Keep badges neatly organized
- Holds 12 swipe/prox badges
- Double vertical display
- Self-adhesive labels
- Industrial-grade plastic
- 14" x 8.25" x 0.68" / 1.1 lbs
- Putty color

500-24 Employee Badge Rack

ITEM NO.
PTI50024

\$28³⁴



- Keep badges neatly organized
- Holds 24 swipe/prox badges
- Double vertical display
- Self-adhesive labels
- Industrial-grade plastic
- 14" x 8.25" x 0.68" / 1.1 lbs
- Putty color

500-4 Employee Badge Rack

ITEM NO.
PTI5004

\$33¹⁴



- Keep badges neatly organized
- Holds 40 swipe/prox badges
- Double vertical display
- Self-adhesive labels
- Industrial-grade plastic
- 14" x 8.25" x 0.68" / 1.1 lbs
- Putty color

400-X Expanding Time Card Rack

ITEM NO.
PTI400-X

\$34⁸⁸



- Expands to hold 25 cards
- Accepts up to 4" x 9" cards
- Lightweight, durable plastic
- Includes numbered labels
- 5" x 3.5" x 34.5" / 3.3 lbs
- Light gray

400-3 Adjustable Time Card Rack

ITEM NO.
PTI4003

\$37⁶⁰



- Accommodates 25 cards
- Accepts badges, 7", 9" cards
- Heavy-duty adjustable plastic
- Won't bend, chip or dent
- 5" x 2.25" x 31" h / 3 lbs
- Light gray

300-1 Metal Time Card Rack

ITEM NO.
PTI3001

\$43³⁵



- 25 card / document capacity
- Accepts up to 4" x 9" cards
- Heavy duty & powder-coated
- Ideal for harsh environments
- 5" x 2" x 37" / 9 lbs
- Charcoal gray

PYRAMID ACCESSORIES

Item Code	Item Description	Fits Model or Series	List
PTI42415	100/pk Attendance Cards	2600, 2650, 2650Pro	\$9.76
PTI3510010	100/pk Weekly Time Cards	3500, 3550SS, 3600SS, 3700HD	\$9.76
PTI4410010	100/pk Weekly Time Cards	4000, 4000HD, 4000Pro, 5000+	\$14.12
PTI42416	Black/Red Ribbon Refill	2600, 2650	\$21.75
PTI43079	Black Ribbon Refill	2600, 2650, 2650Pro	\$21.75
PTI5000R	Black Ribbon Refill	3550SS, 3600SS, 5000+, 5000HD	\$21.75
PTI4000R	Black Ribbon Refill	3500, 3700HD, 4000HD, 4000Pro	\$21.75
PTI42454	15/pk Proximity Badges	TTPROXEK, PPDLAUBKN	\$53.40
PTI42468	5/pk Key Fobs	TTPROXEK, PPDLAUBKN	\$32.70

Call Your Sales Representative Today

MP550 *Atomic Time Recorder and Stamp*

ITEM NO.
CPUMP550

- LCD display, alignment window
- Automatic or manual activation
- Right or left margin, 1 color print
- 300+ custom imprint formats
- 1-8 digit numbering, 9 repeats

- Secure key cover lock
- Supports all pay periods
- Automatic daylight savings
- Power failure protection
- 6 languages, adjustable font

\$299⁰⁰

- 1 year limited warranty
- 6" x 7" x 6" / 5 lbs



ROYAL[®]

TimePilot Tap+ *Portable Time Management System*

ITEM NO.
ADL39182E

- Portable, fast and simple!
- Tap iButton for entry or exit
- USB flash drive data transfer
- View, edit, report, export data
- Interfaces w/payroll systems

- 2,000 employee capacity
- Supports all pay periods
- Multi-company, depts, policies
- Auto reg, overtime, holiday
- Fast recharge via USB to PC

\$369⁹⁹

- 1 yr part, 90 day labor warranty
- 4" x 3" x 1.5" / 5 oz
- Includes 10 iButtons, software
- Uses: 29421N iButtons



TimePilot Vetro *Time Management System*

ITEM NO.
ADL39137S

- Keypad and LCD display
- Tap iButton or PIN entry
- USB flash drive data transfer
- View, edit, report, export data
- Interfaces w/payroll systems

- 500 employee capacity
- Supports all pay periods
- Multi-company, depts, policies
- Auto reg, overtime, holiday
- Stand-by power save mode

\$399⁹⁹

- Optional network connection
- 1 yr part, 90 day labor warranty
- 5" x 2" x 6" / 3 lbs
- Includes 10 iButtons, software
- Uses: 29421N iButtons



TimePilot Extreme Blue II *Blue Time Management System*

ITEM NO.
ADL39211A

- Rugged and weatherproof!
- Tap iButton for clock in/out
- Collect data via Bluetooth
- Smartphone calculates data
- Cut check right at work site
- 2,000 employee capacity

- Handles 12,000 clock in/out
- Supports all pay periods
- Regular, rounding, overtime
- Secure padlock & steel plate
- Free phone app download
- (4) AA battery operation

\$549⁹⁹

- No monthly or annual fees
- 1 yr part, 90 day labor warranty
- 3.8" x 1.8" x 7.3" / 1.3 lbs
- Uses: 29421N iButtons
- Comes with 10 iButtons



HN1500 uPunch Non-Calculating Time Clock Bundle

ITEM NO.
WKWHN1500

\$166⁹⁹



- Time and attendance recording
- Oversized backlit LCD screen
- Date, time, weekday display
- Automatic feed and alignment
- Across the card 2 color printing
- Military or standard time formats
- Track daily or weekly overtime
- Supports all pay periods
- Delivers 6 punches per day

- Auto daylight saving change
- Optional Cloud based software
- Desk or wall mountable
- 2 year limited warranty
- 10.5" x 12" x 11" / 7.5 lbs
- Bundle includes: HN3000 clock, 100 time cards, 1 black ribbon, 2 security keys and a 10-slot card rack**

HN2500 uPunch Non-Calculating Time Clock Bundle

ITEM NO.
WKWHN2500

\$198⁹⁹



- Time and attendance recording
- Large, clear backlit LCD screen
- Date, time, weekday display
- Auto-feed and align technology
- Across the card 2 color printing
- Military or standard time formats
- Up to 50 employees capacity
- Supports all pay periods
- Delivers 4 punches per day

- Auto daylight saving change
- Optional Cloud based software
- Desk or wall mountable
- 2 year limited warranty
- Bundle includes: HN4000 clock, 100 time cards, 1 black ribbon, 2 security keys**

CR1000 uPunch Digital Time Clock and Date Stamp

ITEM NO.
WKWCR1000

\$222⁹⁹



- Time and attendance recording
- Date, time, weekday LCD display
- Strategically placed window
- Automatic or manual activation
- 3 selectable print positions
- Lockable access fraud safeguard
- 12 or 24 hour format, 6 font sizes
- 13 preset comments, 4 languages

- Supports all pay periods
- Auto daylight saving change
- Password protection
- Wall mountable
- 2 year limited warranty
- Bundle includes: CR1000 clock, 50 time cards, 1 black ribbon, 2 security keys**

BN6500 uAttend Fingerprint Time Clock

ITEM NO.
WKWBN6500

\$274⁹⁹



- Biometric fingerprint scanner
- Keypad and LCD display
- Fingerprint, PIN, phone entry
- No more "buddy punching"
- Customize rules and policies
- Data sent to Cloud in real time
- Supports all pay periods
- View & print cards in batches

- Monthly subscription required
- Easily export data, run reports
- Free software upgrades
- Unlimited data and storage
- Android or iPhone phone app
- Connect via WiFi or LAN PC
- Lifetime limited warranty
- 7.5" x 5.5" x 1.5" / 1 lb

CB6500 uAttend WiFi Time Clock

ITEM NO.
WKWCB6500

\$299⁹⁹



- Complete web based system
- Real time data sent to Cloud
- Company logo display & keypad
- Proximity card or PIN entry
- Clear light & audio confirmation

- Comprehensive software
- Set overtime rules and alerts
- Accurate 2 level job tracking
- Review, edit, process payroll
- ADP, Paychex, Quickbooks

- Monthly subscription required
- Unlimited support, data storage
- Lifetime replacement warranty
- 5.5" x 7.5" x 1.5" / 2 lbs
- Includes: 10 RFID badges

WORKWELL ACCESSORIES

Item Code	Item Description	Fits Model or Series	List
WKWCRX90010	Black Clock Ribbon	CR1000	\$16.10
WKWCRTC1050	50pk Weekly Time Cards	CR1000	\$11.00
WKWHNTCL2100	100pk Weekly Time Cards	HN4000	\$19.50
WKWHNTCG1100	100pk 6-Column Time Cards	HN1000, HN3000	\$17.85
WKWHNRG10	Black/Red Clock Ribbon	HN1000, HN3000	\$11.25
WKWHNRL10	Black/Red Clock Ribbon	HN2000, HN4000	\$11.25
WKWRTC10	10pk RFID Proximity Badges	All uAttend Clocks	\$40.00
WKWHNTCR10	10 Slot Card Rack	All uPunch Clocks	\$24.00
WKWHNTCR24	24 Slot Card Rack	All uPunch Clocks	\$40.00
WKWHNTCR50	50 Slot Card Rack	All uPunch Clocks	\$48.00

Call Your Sales Representative Today

COPI-MATE RIBBONS

<i>Fits Model</i>	<i>Item Description</i>	<i>Item Code</i>	<i>List</i>
Acroprint			
125 / 150	Cotton Black	CMR021041	\$8.95
125 / 150	Cotton Blue	CMR021020	\$8.95
125 / 150	Cotton Red	CMR021031	\$8.95
125 / 150	Cotton Green	CMR021052	\$13.95
125 / 150	Nylon purple	CMR20361	\$5.95
125 / 150	Nylon purple/red	CMR20246	\$8.95
200	Nylon purple	CMR430001-N1P	\$7.95
ATT175 / 310 / ES700 / 900	Nylon black	CMR310001K	\$19.50
ATT175 / 310 / ES700 / 900	Nylon purple	CMR021070	\$13.95
ATT175 / 310	Nylon red	CMR310001R	\$19.50
ATR120 / ATR420	Nylon black/red	CMR310003KR	\$13.95
ATR440	Nylon black/red	CMR360001KR	\$13.95
ET / ETC	Nylon purple	CMR410003-N1P	\$7.95
ET / ETC	Nylon black	CMR410003-N1K	\$7.95
Amano/Cincinnati			
BX-1500, MRX-35	Nylon black	CMR320001K	\$13.95
PIX / TCX series, CP-3000	Nylon black	CMR320006K	\$19.50
PIX / TCX series	Nylon red	CMR320006R	\$19.50
PIX / TCX series	Nylon purple	CMR21501	\$10.99
PIX3000	Nylon black/red	CMR21507	\$10.99
Lathem			
1500E / 5000EP / 7000E	Nylon black	CMR310001K	\$19.50
2100 / 3000 / 4000	Nylon blue/red	CMR440001-N2BR	\$7.95
5000E	Nylon red	CMR310001R	\$19.50
OMNICHRON II	Nylon purple	CMR60E005P	\$9.95
Pyramid			
3500 / 3700 / 4000	Nylon purple	CMR370002P	\$14.95
3500 / 3700 / 4000	Nylon black	CMR370002K	\$14.95
Rapidprint			
ADE / ARC / ARL	Nylon black	CMR401000-N1K	\$7.95
ADE / ARC / ARL	Nylon purple	CMR401000-N1P	\$7.95
C-650	Cotton purple	CMR400650-C1P	\$15.00
C-650	Cotton purple/red/green	CMR400650-C3PRG	\$20.00
C-724	Nylon purple	CMR402016-N1P	\$20.00
Simplex			
Bravo / Combo	Nylon purple	CMR350001P	\$19.50
HA2G	Cotton purple	CMR450001-C1P	\$7.95
TR1	Nylon black	CMR450002-N1K	\$10.00
TR2A/TR2C	Nylon black	CMR350002K	\$25.00
Uchida			
P-15	Nylon black	CMRUCH101000	\$14.99
P-15	Nylon red	CMRUCH101010	\$14.99
Widmer			
T-3 / T-LED-3,N,D	Nylon black	CMR401000-N1K	\$7.95
T-3 / T-LED-3,N,D	Nylon purple	CMR401000-N1P	\$7.95
T-3 / T-LED-3,N,D	Cotton purple/red/green	CMR25909	\$19.95
S-3	Cotton purple/red/green	CMR401000-C3PRG	\$25.00
776	Nylon purple	CMR402016-N1P	\$20.00

PS140 PaperSAFE® Deskside Shredder

ITEM NO.
DAH23140

\$229⁰⁰



- 8.75" throat width, 1-3 users
- 10 sheet capacity, 11 fpm
- 3/16" x 1-1/16" shred size
- Security level P-4
- Shreds staples, clips, CCs
- 4 gallon waste bin w/window

- Quality German engineered
- Thermally protected motor
- Built-in jam protection
- Oil-free performance
- 1 yr warranty, 5 on cutters
- 8.5" x 13.75" x 14.5" / 9.5 lbs

PS240 PaperSAFE® Deskside Shredder

ITEM NO.
DAH23240

\$240⁰⁰



- 8.75" throat width, 1-3 users
- 10 sheet capacity, 10 fpm
- 1/8" x 7/16" shred size
- Security level P-4
- Shreds staples, clips, CCs, CDs
- 7 gallon waste bin w/window

- Quality German engineered
- Thermally protected motor
- Automatic jam protection
- Oil-free performance
- 1 yr warranty, 5 on cutters
- 10.5" x 17.5" x 21.5" / 19.8 lbs

SM90 ShredMATIC® Auto-Feed Shredder

ITEM NO.
DAH35090

\$499⁰⁰



- 8.75" throat width, 1-5 users
- 10 sheet manual capacity
- Lockable 90 sheet auto-feed
- 3/16" x 1/2" shred size
- Security level P-4
- Shreds staples, clips, CCs
- 7 gallon waste bin w/window

- Quality German engineered
- SmartPower Energy Managing
- Automatic jam protection
- Oil-free performance, castors
- 1 yr warranty, 5 on cutters
- 10.3" x 14.5" x 20" / 20 lbs

SM300 ShredMATIC® Auto-Feed Shredder

ITEM NO.
DAH35314

\$999⁰⁰



- 8.75" throat width, 1-5 users
- 14 sheet manual capacity
- Lockable 300 sheet auto-feed
- 3/16" x 5/8" shred size
- Security level P-4
- Shreds staples, clips, CCs, CDs
- 11 gallon waste bin w/window

- Quality German engineered
- SmartPower Energy Managing
- Automatic jam protection
- Oil-free performance, castors
- 1 yr warranty, 5 on cutters
- 14" x 16" x 27.5" / 41 lbs

DAH35150 (150 Sheets) **\$699.00**

50114 MHP Oil-Free Small Office Shredder

ITEM NO.
DAH50114

\$1,050⁰⁰



- Oil and Maintenance Free
- 9.5" throat width, 2-4 users
- 10-12 sheet capacity, 22 fpm
- 1/8" x 1-9/16" shred size
- Security level P-4
- Shreds staples, clips, CCs
- 8 gallon waste volume

- Trident Grip Jam Protection
- SmartPower Energy Mgt. System
- Matrix High Perform Cylinders
- 2 yr warranty, lifetime cylinders
- 17" x 13.75" x 24.75" / 50 lbs

DAH50214 (10-12 sheets/11 gal waste) **\$1,300.00**

50310 Matrix Oil-Free Small Office Shredder

ITEM NO.
DAH50310

\$1,650⁰⁰



- Oil and Maintenance Free
- 10.25" throat width, 2-4 users
- 20-22 sheet capacity
- 3/16" x 1-9/16" shred size
- Security level P-3
- Shreds staples, clips, CCs, CDs
- 23 gallon waste volume

- Trident Grip Jam Protection
- SmartPower Energy Mgt. System
- Matrix High Performance cylinders
- 2 yr warranty, lifetime cylinders
- 17.25" x 21.5" x 34.25" / 89 lbs
- Uses 20725 bags

50314 MHP Oil-Free Small Office Shredder

ITEM NO.
DAH50314

\$1,850⁰⁰



- Oil and Maintenance Free
- 10.25" throat width, 2-4 users
- 16-18 sheet capacity, 20 fpm
- 1/8" x 1-9/16" shred size
- Security level P-4
- Shreds staples, clips, CCs, CDs

- 23 gallon waste volume
- Trident Grip Jam Protection
- SmartPower Energy Mgt. System
- Matrix High Perform Cylinders
- 2 yr warranty, lifetime cylinders
- 21.5" x 17" x 34.25" / 89 lbs

DAH50414 (18-20 sheets/30 gal waste) **\$2,600.00**

50410 Matrix Oil-Free Office Shredder

ITEM NO.
DAH50410

\$2,100⁰⁰



- Oil and Maintenance Free
- 10.25" throat width, 3-5 users
- 20-22 sheet capacity
- 3/16" x 1-9/16" shred size
- Security level P-3
- Shreds staples, clips, CCs, CDs
- 30 gallon waste volume

- Trident Grip Jam Protection
- SmartPower Energy Mgt. System
- Matrix High Performance cylinders
- 2 yr warranty, lifetime cylinders
- 17.25" x 21.5" x 36.75" / 119 lbs
- Uses 20725 bags

50464 MHP Oil-Free Small Department Shredder

ITEM NO.
DAH50464

\$3,000⁰⁰



- Oil and Maintenance Free
- 12" throat width, 3-5 users
- 24-26 sheet capacity, 20 fpm
- 1/8" x 1-9/16" shred size
- Security level P-4
- Shreds staples, clips, CCs, CDs

- 30 gallon waste volume
- Trident Grip Jam Protection
- SmartPower Energy Mgt. System
- Matrix High Perform Cylinders
- 2 yr warranty, lifetime cylinders
- 21.5" x 17.5" x 36.75" / 119 lbs

DAH50564 (22-24 sheets/45 gallon) **\$4,000.00**

51214 CleanTEC Oil-Free Shredder

ITEM NO.
DAH51214

\$1,550⁰⁰



- Oil and Maintenance Free
- 9.5" throat width, 2-4 users
- 10-12 sheet capacity
- 1/8" x 1-9/16" shred size
- Security level P-4
- Shreds staples and paper clips
- 11 gallon waste volume

- Fine dust filter for cleaner air
- Automatic Jam Protection
- SmartPower Energy Mgt. System
- 2 yr warranty, lifetime cylinders
- 13.75" x 17" x 28" / 50 lbs
- Uses 20724 bags

DAH51314 (16-18 sheets/23 gal waste) **\$2,150.00**

51414 CleanTEC Oil-Free Shredder

ITEM NO.
DAH51414

\$2,900⁰⁰



- Oil and Maintenance Free
- 10.25" throat width, 3-5 users
- 18-20 sheet capacity
- 1/8" x 1-9/16" shred size
- Security level P-4
- Shreds staples, clips, CDs, DVDs
- 30 gallon waste volume

- Fine dust filter for cleaner air
- Automatic Jam Protection
- SmartPower Energy Mgt. System
- 2 yr warranty, lifetime cylinders
- 17.25" x 21.5" x 36.75" / 95 lbs
- Uses 20725 bags

DAH51514 (26-28 sheets/38 gal waste) **\$3,650.00**

40334 High Security Small Office Shredder

ITEM NO.
DAH40334

\$3,300⁰⁰



- 10.25" throat width, 2-5 users
- Up to 8 sheet capacity, 22 fpm
- 1mm x 4.7mm shred size
- Security level P-7
- Shreds paper only
- 23 gallon waste volume
- Precision milled solid cylinders

- SmartPower Energy Mgt. System
- Shock Mounted quiet operation
- EvenFlow lubricating system
- NSA approved; ETL certified
- 2 yr warranty, 1 yr on cylinders
- 21.5" x 17" x 34.3" / 88 lbs

DAH40434 (8-10 sheets/30 gallon) **\$4,700.00**

40534 High Security Small Department Shredder

ITEM NO.
DAH40534

\$5,400⁰⁰



- 12" throat width, 5+ users
- Up to 12 sheet capacity, 23 fpm
- 1mm x 4.7mm shred size
- Security level P-7
- Shreds paper only
- 38 gallon waste volume
- Precision milled cutting cylinders

- SmartPower Energy Mgt. System
- Shock Mounted quiet operation
- EvenFlow lubricating system
- NSA approved; ETL certified
- 2 yr warranty, 1 yr on cylinders
- 29" x 20" x 34.5" / 132 lbs

20392 High Capacity Cross Cut Shredder

ITEM NO.
DAH20392

\$8,600⁰⁰



- 16" throat width, 2.5 HP
- 25-30 sheet capacity, 22 fpm
- 1/12" x 9/16" shred size
- Security level P-5
- Shreds staples, clips, CCs, CDs
- 50 gallon waste volume

- Precision milled cutting cylinders
- Thermally protected motor
- Shock Mounted quiet operation
- 2 yr warranty, lifetime cylinders
- 27.5" x 24" x 46.5" / 328 lbs

DAH20396 (38-42 sheets/50 gallon) **\$8,600.00**

DAH20394 (9-11 sheets/50 gallon) **\$9,900.00**

DAHLE Accessories

Item Code	Description	Fits Machine Model	Qty	List
DAH20721	12 ounce bottles	Shredder oil for all models	6	\$78.00
DAH20722	1 gallon bottles	Shredder oil for all models	4	\$225.00
DAH20723	8 gallon bags	For 401xx, 501xx shredders	200	\$120.00
DAH20724	11 gallon bags	For 402xx, 412xx 502xx shredders	100	\$120.00
DAH20725	30 gallon bags	For 403xx, 413xx 503xx, 404xx, 414xx, 504xx shredders	100	\$140.00
DAH20726	50 gallon bags	For 405xx, 415xx 505xx, and larger shredders	100	\$150.00

P-35C Powershred® Cross Cut Personal Shredder

*Must buy in multiples of 2

ITEM NO.
FEL3213501

\$114⁹⁰



- 9" throat width, 1 user
- 5 sheet capacity, 7 fpm
- 5/32" x 1-9/16" shred size
- Security level P-4
- Runtime 2 on / 20 off
- Shreds staples, clips, CCs

- 3 gallon basket w/lift-off head
- Easy empty w/recessed handle
- Patented Safety Lock
- 1 year warranty, 3 year on cutters
- 13.8" x 7.9" x 12.6" / 8 lbs
- Uses: FEL35250 oil

11C Powershred® Cross Cut Personal Shredder

*Must buy in multiples of 2

ITEM NO.
FEL4350001

\$202⁹⁹



- 9" throat width, 1 user
- 11 sheet capacity, 8 fpm
- 5/32" x 2" shred size
- Security level P-3
- Runtime 5 on / 30 off
- Shreds staples, credit cards

- 4.75 gallon bin w/lift-off head
- Patented Safety Lock
- 1 year warranty, 3 on cutters
- 13.6" x 9.4" x 17" / 14 lbs
- Uses: FEL35250 oil

60Cs Powershred® Cross Cut Personal Shredder

*Must buy in multiples of 2

ITEM NO.
FEL4606001

\$273⁹⁹



- 9" throat width, 1 user
- 10 sheet capacity, 14 fpm
- 5/32" x 2" shred size
- Security level P-3
- Runtime 6 on / 20 off
- Shreds staples, clips, CCs

- 6 gallon bin w/lift-off head
- SafeSense® Technology
- 1 year warranty, 5 on cutters
- 9" x 14.6" x 16" / 13 lbs
- Uses: FEL35250 oil

12Cs Powershred® Cross Cut Personal Shredder

ITEM NO.

FEL4360001

\$370⁹⁹



- 9" throat width, 1 user
- 12 sheet capacity, 8 fpm
- 5/32" x 2" shred size
- Security level P-3
- Runtime 5 on / 30 off
- Shreds staples, paper clips, credit cards and junk mail

- 4 gallon basket w/window
- Auto on/off, reverse mode
- SafeSense® Technology
- 1 year warranty, 5 on cutters
- 9.2" x 17" x 15.4" / 19 lbs
- Uses: FEL35250 oil

62Mc Powershred® Micro Cut Shredder

ITEM NO.

FEL4685101

\$295⁹⁹



- 9" throat width, 1 user
- 10 sheet capacity, 9 fpm
- 7/64" x 25/64" shred size
- Security level P-5
- Runtime 7 on / 60 off
- Shreds staples, credit cards
- 5 gallon basket w/window

- Patented safety lock
- Castors for mobility
- 1 year warranty, 5 on cutters
- 13.75" x 10.4" x 18.75" / 21 lbs
- Uses: FEL35250 oil

63Cb Powershred® Cross Cut Shredder

ITEM NO.

FEL4600001

\$357⁹⁹



- 9" throat width, 1 user
- 10 sheet capacity, 10 fpm
- 5/32" x 2" shred size
- Security level P-3
- Runtime 8 on / 20 off
- Shreds staples, clips, CCs
- 5 gallon basket w/window
- Jam Blocker™ Technology

- SafeSense® Technology
- Energy Savings System
- 1 year warranty, 5 on cutters
- 15.2" x 10.9" x 18" / 19 lbs
- Uses: FEL35250 oil

70S Powershred® Strip Cut Shredder

ITEM NO.

FEL4671001

\$526⁹⁹



- 9" throat width, 1 user
- 14 sheet capacity, 11 fpm
- 7/32" shred size
- Security level P-2
- Runtime 12 on / 20 off
- Shreds staples, paper clips
- Credit cards, CDs, junk mail

- 7 gallon basket w/window
- Patented Safety Lock
- 1 year warranty, 5 on cutters
- 15" x 11.3" x 20.25" / 24 lbs
- Uses:35250 oil

90S Powershred® Strip Cut Shredder

ITEM NO.

FEL4690001

\$705⁹⁹



- 9" throat width, 1-3 users
- 18 sheet capacity, 12 fpm
- 7/32" shred size, level P-2
- Runtime 25 on / 40 off
- Shreds staples, paper clips
- Credit cards, CDs, junk mail
- 9 gallon basket w/window

- Separate bin for multimedia
- SilentShred technology
- 100% jam proof system
- 2 year warranty, 5 on cutters
- 11.4" x 17.3" x 25.2" / 36.4 lbs

Call Your Sales Representative Today

LX200 IntelliBAR™ Micro Cut Personal Shredder

ITEM NO.
FEL5015001

\$385⁹⁹



- 9" throat width, 1 user
- 12 sheet capacity, 9 fpm
- 5/32" x 1/2" shred size
- Security level P-4
- Runtime 10 on / 15 off
- Shreds staples, clips, CCs
- 6 gallon bin with window

- SafeSense Technology
- 100% Jam Proof System
- Bin full, runtime indicators
- Quiet operation, castors
- 2 yr warranty, 7 on cutters
- 20.4" x 14.5" x 10.3" / 20.5 lbs
- Also available in white

FEL5015201 (LX210 16 Sht Cap) **\$433.99**

LX200 IntelliBAR™ Micro Cut Personal Shredder

ITEM NO.
FEL5015401

\$511⁹⁹



- 9" throat width, 1-3 users
- 20 sheet capacity, 7 fpm
- 5/32" x 1/2" shred size
- Security level P-4
- Runtime 30 on / 15 off
- Shreds staples, clips, CCs
- 8 gallon pullout bin

- SafeSense Technology
- 100% Jam Proof System
- Bin full, runtime indicators
- Quiet operation, castors
- 2 yr warranty, 7 on cutters
- 23.3" x 16.5" x 11.75" / 34 lbs
- Also available in white

450M Microshred™ Micro Cut Shredder

ITEM NO.
FEL4074001

\$620⁹⁹



- 8.7" throat width, 1-3 users
- 9 sheet capacity, 7 fpm
- 5/64" x 1/2" shred size
- Security level P-5
- Runtime 10 on / 45 off
- Shreds staples, CCs, CDs
- 5.8 gallon basket w/window

- Auto Reverse
- Separate CD entry & waste bin
- SilentShred™ operation
- 1 year warranty, 5 on cutters
- 13.8" x 10.25" x 22.3" / 23 lbs
- Uses: 36052 bags, 35250 oil

150C AutoMax™ Auto Feed Cross Cut Shredder

ITEM NO.
FEL4656001

\$659⁹⁹



- Small or home office, 1 user
- 150 shts automatic, 8 manual
- 5/32" x 1-1/2" shred size
- Security level P-4
- Shreds staples, clips, CCs, CDs credit cards, CDs, junk mail
- 8.5 gallon basket w/window
- Touch screen display

- SilentShred™ operation
- Fast AccuFeed System
- Auto reverses & Sleep mode
- Runtime 10 on/25 off , 11 fpm
- 2 year warranty, 5 on cutters
- 21.4" x 13.6" x 20" / 34 lbs
- Uses: 36053 bags, 35250 oil

99Ms Microshred™ Micro Cut Professional Shredder

ITEM NO.
FEL4609001

\$1,011⁹⁹



- 9" throat width, 1-3 users
- 14 sheet capacity, 11 fpm
- 5/64" x 9/16" shred size
- Security level P-5
- Runtime 20 on / 40 off
- Shreds staples, credit cards
- 9 gallon pull-out bin

- SafeSense® Technology
- SilentShred™ operation
- Energy savings sleep mode
- 1 year warranty, 7 on cutters
- 11.4" x 17.3" x 25" / 42 lbs
- Uses: 36053 bags, 35250 oil

200M AutoMax™ Auto Feed Micro Cut Shredder

ITEM NO.
FEL4656201

\$1,402⁹⁹



- Small or home office, 1 user
- 200 shts automatic, 10 manual
- 5/64" x 35/64" shred size
- Security level P-5
- Shreds staples, credit cards
- 8.5 gallon basket w/window
- Touch screen display

- SilentShred™ operation
- Fast AccuFeed System
- Auto reverses & Sleep mode
- Runtime 12 on/20 off , 9 fpm
- 2 year warranty, 7 on cutters
- 13.6" x 20" x 22.2" / 36 lbs
- Uses: 36053 bags, 35250 oil

225Mi Microshred™ 100% Jam Proof Micro Cut Commercial Shredder

ITEM NO.
FEL4620001

\$2,853⁹⁹



- 9.5" throat width, 3-5 users
- 16 sheet capacity, 14 fpm
- 5/64" x 15/32" shred size
- Security level P-5
- Shreds staples, paper clips
- Credit cards, CDs, junk mail
- 16 gallon removable basket
- 100% Jam Proof System

- SafeSense® Technology
- SilentShred™ operation
- Continuous duty
- Energy Savings System
- 2 year warranty, 7 on cutters
- 17.8" x 17" x 30.75" / 90 lbs
- Uses: 36054 bags, 35250 oil

350C AutoMax™ Auto Feed Cross Cut Shredder

ITEM NO.
FEL4964001

\$1,815⁹⁹



- Pull-out front drawer loading
- 350 shts automatic, 12 manual
- 5/32" x 1-1/2" shred size
- Security level P-4
- Shreds staples, paper clips, credit cards, CDs, junk mail
- 18 gallon corrugated bin
- Touch screen display

- Fast AccuFeed System
- Sleep mode, SmartLock™
- Continuous duty
- 2 year warranty, 20 on cutters
- 15.4" x 22.8" x 32.1" / 99 lbs
- Uses: 36054 bags, 35250 oil

FEL5015201 (550 sheets) **\$2,605.00**

73Ci Powershred® 100% Jam Proof Cross Cut Shredder

ITEM NO.
FEL4601001

\$569⁹⁹



- 9" throat width, 1 user
- 12 sheet capacity, 10 fpm
- 5/32" x 1-1/2" shred size
- Security level P-4
- 6 gallon basket w/window
- Shreds staples, clips, CCs, CDs
- 100% Jam Proof system

- Back-lit LED touch screen
- SafeSense® Technology
- Energy Savings System
- 1 year warranty, 5 on cutters
- 15.5" x 11.3" x 21" / 24 lbs
- Uses: 36052 bags, 35250 oil

79Ci Powershred® 100% Jam Proof Cross Cut Deskside Shredder

ITEM NO.
FEL3227901

\$660⁹⁹



- 9" throat width, 1 user
- 16 sheet capacity, 10 fpm
- 5/32" x 1-1/2" shred size
- Security level P-4
- Runtime 20 on / 30 off
- Shreds staples, paper clips, credit cards, CDs, junk mail
- 6 gallon basket w/window

- 100% Jam proof system
- SafeSense® Technology
- SilentShred™ operation
- Energy Savings System
- 2 year warranty, lifetime on cutters
- 15.8" x 10.4" x 21.3" / 28 lbs
- Uses: 36052 bags, 35250 oil

99Ci Powershred® 100% Jam Proof Professional Shredder

ITEM NO.
FEL3229901

\$845⁹⁹



- 9" throat width, 1-3 users
- 18 sheet capacity, 10 fpm
- 5/32" x 1-1/2" shred size
- Security level P-4
- Runtime 30 on / 40 off
- Shreds staples, paper clips, credit cards, CDs, junk mail
- 9 gallon basket w/window
- 100% Jam Proof system

- SafeSense® Technology
- SilentShred™ operation
- Energy Savings System
- 2 yr warranty, lifetime on cutters
- 11.4" x 17.3" x 25" / 37 lbs
- Uses: 36053 bags, 35250 oil

125Ci Powershred® 100% Jam Proof Professional Shredder

ITEM NO.
FEL3312501

\$1,518⁹⁹



- 9" throat width, 1-2 users
- 20 sheet capacity, 16 fpm
- 5/32" x 1-1/2" shred size
- Security level P-4
- Shreds staples, paper clips, credit cards, CDs, junk mail
- 14 gallon pullout basket
- 100% Jam Proof System

- SafeSense® Technology
- SilentShred™ operation
- Energy Savings System
- Continuous duty
- 2 yr warranty, lifetime on cutters
- 21" x 11.3" x 29" / 55 lbs
- Uses: 36054 bags, 35250 oil

FEL3312001 (125i Strip Cut, P-2)..... **\$1,304.99**

225Ci Powershred® 100% Jam Proof Commercial Shredder

ITEM NO.
FEL3825001

\$2,147⁹⁹



- 9.5" throat width, 3-5 users
- 22 sheet capacity, 14 fpm
- 5/32" x 1-1/2" shred size
- Security level P-4
- Shreds staples, paper clips, credit cards, CDs, junk mail
- 16 gallon removable basket
- 100% Jam Proof System

- SafeSense® Technology
- SilentShred™ operation
- Energy Savings System
- 2 year warranty, lifetime on cutters
- 17.8" x 17" x 30.75" / 90 lbs
- Uses: 36054 bags, 35250 oil

FEL3322001 (225i Strip Cut, P-2) **\$1,874.99**

325Ci Powershred® 100% Jam Proof Commercial Shredder

ITEM NO.
FEL3831001

\$3,884⁹⁹



- 9.5" throat width, 6-10 users
- 30 sheet capacity, 15 fpm
- 5/32" x 1-1/2" shred size
- Security level P-4
- Shreds staples, paper clips, credit cards, CDs, junk mail
- 22 gallon removable basket
- 100% Jam Proof System

- SafeSense® Technology
- SilentShred™ operation
- Energy Savings System
- Continuous duty
- 2 year warranty, lifetime on cutters
- 20" x 18" x 34.7" / 94 lbs
- Uses: 36056 bags, 35250 oil

FEL3830001 (325i Strip Cut, P-2) **\$3,451.99**

425Ci Powershred® 100% Jam Proof Commercial Shredder

ITEM NO.
FEL38425

\$4,499⁹⁹



- TAA Compliant
- 12" throat width, 10+ users
- 30 sheet capacity, 20 fpm
- 5/32" x 1-1/8" shred size
- Security level P-4
- Shreds staples, paper clips, credit cards, CDs, junk mail
- 30 gallon corrugated bin

- 100% Jam Proof System
- SafeSense® Technology
- 425Ci with Auto-Oil™
- Energy Savings System
- 2 year warranty, lifetime on cutters
- 22" x 20" x 37.3" / 151 lbs
- Uses: 3605801 bags, 35250 oil

FEL38420 (425i Strip Cut, P-2) **\$4,099.99**

485Ci Powershred® 100% Jam Proof Commercial Shredder

ITEM NO.
FEL38485

\$5,889⁹⁹



- TAA Compliant
- 16" throat width, 10+ users
- 30 sheet capacity, 20 fpm
- 5/32" x 1-1/8" shred size
- Security level P-4
- Shreds staples, paper clips, credit cards, CDs, junk mail
- 35 gallon corrugated bin

- 100% Jam Proof System
- SafeSense® Technology
- 485Ci with Auto-Oil™
- Energy Savings System
- 2 yr warranty, lifetime on cutters
- 25" x 20" x 37.3" / 179 lbs
- Uses: 3605801 bags, 35250 oil

FEL38480 (485i Strip Cut, P-2) **\$5,330.99**

2250C Fortishred™ TAA Cross Cut Commercial Shredder

ITEM NO.
FEL4616001

\$2,368⁹⁹



- 10.25" throat width, 3-5 users
- 12-14 sheet capacity, 20 fpm
- 5/32" x 1-9/16" shred size
- Security level P-4
- Staples, clips, CCs, CDs, JM
- 20 gallon removable basket
- Auto reverses & Safety Shield

- SilentShred™ operation
- Needs dedicated 15 Amp outlet
- Automatic shut off
- Continuous duty, TAA Compliant
- 2 year warranty, 30 on cutters
- 19.7" x 15" x 34.3" / 71 lbs
- Uses: 36054 bags, 35250 oil

FEL4616601 (2250M Micro Cut, P-5) **\$2,703.99**

3850C Fortishred™ TAA Cross Cut Commercial Shredder

ITEM NO.
FEL4617801

\$3,599⁹⁹



- 15.75" throat width, 6-10 users
- 22-24 sheet capacity, 16 fpm
- 5/32" x 1-9/16" shred size
- Security level P-4
- Staples, clips, CCs, CDs, JM
- 44 gallon removable basket
- Sheet Capacity Sensor

- Safety Shield & SilentShred™
- Auto shut off
- Needs dedicated 15 Amp outlet
- Continuous duty, TAA Compliant
- 2 year warranty, 30 on cutters
- 25.2" x 23.3" x 38.2" / 185 lbs
- Uses: 3604101 bags, 3505701 oil

HS-440 Fortishred™ TAA High Security Shredder

ITEM NO.
FEL3306301

\$2,414⁹⁹



- 9.5" throat width, 1-3 users
- 4 sheet capacity, 14 fpm
- 1/32" x 3/16" shred size
- NSA approved level P-7
- Shreds paper only
- 9.25 gallon removable basket
- Electronic Safety Shield

- Automatic reverse and shut off
- SilentShred™ operation
- Requires 15 Amp outlet
- Continuous duty, TAA Compliant
- 1 year limited warranty
- 15.5" x 11.75" x 25" / 48 lbs
- Uses: 36053 bags, 3505701 oil

HS-1010 Fortishred™ TAA High Security Shredder

ITEM NO.
FEL3306601

\$12,643⁹⁹



- 12" throat width, 10+ users
- 10 sheet capacity, 24 fpm
- 1/32" x 3/16" shred size
- NSA approved level P-7
- Shreds paper only
- 44 gallon removable basket
- Sheet Capacity Sensor
- Electronic Safety Shield

- Requires a 20 Amp outlet
- Auto shut off, SilentShred™
- Auto-Oil™ extends cutter life
- 1 year limited warranty
- 21.5" x 23.5" x 40" / 242 lbs
- 3604101 bags, 3505801 oil

FELLOWES ACCESSORIES

Item Code	Size	Fits Machine Model	Qty	List
FEL36052	6-7 gallons	63Cb, 73Ci, 79Ci, 450M, 46Ms	100	\$41.99
FEL36053	9 gallons	99Ci, 99Ms, HS-440, AutoMax 130c and 200c	100	\$44.99
FEL36054	14-20 gallons	125, 225 and 2250 Series	50	\$31.59
FEL3608401	16-20 gallons	AutoMax 300c, 500c, 300cl, 500cl	50	\$35.29
FEL36056	25 gallons	325 Series	50	\$38.59
FEL36055	32 gallons	385 Series	50	\$66.99
FEL3605801	32-38 gallons	425 and 485 Series	50	\$67.99
FEL3604101	50 gallons	C-525, 3850 Series, HS-660 and 1010	50	\$62.99
FEL35250	12 oz bottle	Shredder oil for most models	1	\$19.95
FEL3505701	12 oz bottle	Shredder oil for 2250c, 3850c, HS-440	1	\$24.95
FEL3505801	32 oz bottle	Oil for Auto oil units: C-525, HS-660 and 1010	1	\$32.95

60X Stack-and-Shred™ Automatic Personal Shredder

ITEM NO.
GBC1757572

\$426⁹⁹



- 9" throat width, 1 user
- 60 page stack capacity, 5 fpm
- 5 sheet manual bypass
- 3/16" x 1-3/4" cross cut shreds
- Security level P-3
- Shreds staples, clips, CCs
- 4 gallon drawer w/window

- Illuminated status symbols
- Quiet operation / 60 dB
- 1 year limited warranty
- 11.5" x 16" x 12.75" / 17 lbs
- Uses: 1765016 bags

80X Stack-and-Shred™ Automatic Personal Shredder

ITEM NO.
GBC1757574

\$562⁹⁹



- 9" throat width, 1 user
- 80 page stack capacity, 5 fpm
- 6 sheet manual bypass
- 3/16" x 1-3/4" cross cut shreds
- Security level P-3
- Shreds staples, clips, CCs
- 5 gallon drawer w/window
- Illuminated status symbols

- Power Save w/auto wakeup
- Auto+ Jam Clearance
- Self-cleaning cutters
- 1 year limited warranty
- 11.5" x 16.25" x 15" / 20 lbs
- Uses: 1765016 bags

130X Stack-and-Shred™ Automatic Executive Shredder

ITEM NO.
GBC1757571

\$719⁹⁹



- 9" throat width, 1-2 users
- 130 page stack capacity, 7 fpm
- 6 sheet manual bypass
- 3/16" x 1-1/2" super cross cut
- Security level P-4
- Shreds staples, clips, CCs
- 7 gallon drawer w/window
- Illuminated status symbols

- Power Save w/auto wakeup
- Auto+ Jam Clearance
- Self-cleaning cutters
- 2 year warranty, 7 on cutters
- 12" x 17.5" x 16.25" / 25 lbs
- Uses: 1765016 bags

230X Stack-and-Shred™ Automatic Small Office Shredder

ITEM NO.
GBC1757573

\$1,409⁹⁹



- 9" throat width, 1-5 users
- 230 page stack capacity, 8 fpm
- 7 sheet manual bypass
- 3/16" x 1-1/2" super cross cut
- Security level P-4
- Shreds staples, clips, CCs, CDs
- 9 gallon drawer w/window
- Illuminated status symbols

- Power Save w/auto wakeup
- Auto+ Jam Clearance
- Self-cleaning cutters, castors
- 2 year warranty, 10 on cutters
- 13.75" x 18.5" x 22" / 46 lbs
- Uses: 1765010 bags

300M Stack-and-Shred™ Automatic Departmental Shredder

ITEM NO.
GBC1758576

\$2,786⁹⁹



- 9" throat width, 5-10 users
- 300 page stack, 7 sheet bypass
- 1/8" x 1/2" micro cut
- Security level P-5
- Shreds staples, clips, CCs, CDs
- 11 gallon bin w/full indicator
- Programmable PIN code lock

- Power Save w/auto wakeup
- Auto+ Jam Clearance
- Self-cleaning cutters, castes
- Runtime 16 on / 40 of
- 2 year warranty, 15 on cutters
- 13.75" x 18.5" x 25" / 59 lbs

600M Stack-and-Shred™ Automatic Departmental Shredder

ITEM NO.
GBC1758577

\$5,590⁹⁹



- 9" throat width, 10-20 users
- 600 page stack, 9 sheet bypass
- 1/8" x 1/2" micro cut
- Security level P-5
- Shreds staples, clips, CCs, CDs
- 21 gallon bin w/full indicator
- Programmable PIN code lock

- Power Save w/auto wakeup
- Auto+ Jam Clearance
- Self-clean and SelfOil
- Continuous duty; castors
- 2 year warranty, 15 on cutters
- 20" x 21" x 32" / 78 lbs

750M Stack-and-Shred™ Automatic Large Office Shredder Shredder

ITEM NO.
GBC1758578

\$8,459⁹⁹



- 9" throat width, 20+ users
- 750 page stack, 10 sheet bypass
- 1/8" x 1/2" micro cut
- Security level P-5
- Shreds staples, clips, CCs, CDs

- 31 gallon bin w/full indicator
- Programmable PIN code lock
- Power Save w/auto wakeup
- Interactive Auto+ Jam Clearance
- Intelligent Self-clean & SelfOil

- Continuous duty; castors
- 2 year warranty, 20 on cutters
- 20" x 21" x 37.5" / 98 lbs

Call Your Sales Representative Today

PS06-02 Strip Cut Personal Shredder

ITEM NO.
GBC1757402

\$84⁰⁰



- 9" throat width
- 6 sheet capacity
- 1/4" strip shred size
- Security level P-2
- Shreds junk mail, staples
- Recessed blades for safety
- 2.38 gallon bin w/lift-off head
- Start/stop slider switch
- Status indicator lights
- Manual reverse on jam
- 2 year limited warranty
- 12" x 11.3" x 6.2" / 5.6 lbs

GBC1757403 (PX08-04 Cross Cut, P-3) **\$102.00**

PX06-04 Super Cross Cut Personal Shredder

ITEM NO.
GBC1757403

\$109⁰⁰



- 9" throat width, 1 user
- 6 sheet capacity, 3 min run
- 3/16" x 1-1/2" shred size
- Security level P-4
- Shreds staples, paper clips
- Recessed blades for safety
- 3.96 gallon bin w/lift-off head
- Start/stop slider switch
- Status indicator lights
- Manual reverse on jam
- 2 year limited warranty
- 13.5" x 12.8" x 9" / 12 lbs

PX12-06 Cross Cut Home Office Shredder

ITEM NO.
GBC1757406

\$170⁰⁰



- 9" throat width, 1 user
- 12 sheet capacity, 6 min run
- 5/32" x 1-3/4" shred size
- Security level P-3
- Shreds paper, staples
- 6 gallon pullout bin/window
- Front facing for beside desk
- Whisper Shred Technology
- User friendly touch controls
- Automatic reverse on jam
- Recessed blades for safety
- 2 year limited warranty
- 16.7" x 14" x 9.4" / 14 lbs

GBC1757408 (PS12-06 Side-facing) **\$170.00**

PSX10-06 Super Cross Cut Home Office Shredder

ITEM NO.
GBC1757407

\$182⁰⁰



- 9" throat width, 1 user
- 10 sheet capacity, 6 min run
- 3/16" x 1-1/2" shred size
- Security level P-4
- Shreds staples, paper clips
- 6 gallon pullout bin/window
- Side facing for under desk
- Whisper Shred Technology
- User friendly touch controls
- Automatic reverse on jam
- Recessed blades for safety
- 2 year limited warranty
- 14.8" x 14.6" x 10" / 15.7 lbs

GBC1757405 (PX10-06 Front-facing) **\$182.00**

EX10-05 Super Cross Cut Personal Shredder

ITEM NO.
GBC1757393

\$292⁰⁰



- 9" throat width, 1 user
- 10 sheet capacity, 10 fpm
- 5/32" x 1-1/2" shred size
- Security level P-4
- Shreds staples, clips, CCs, CDs
- 5 gallon basket w/window
- Separate CD slot & waste bin
- Non-stop Jam Free indicator
- Eco power save feature
- 1 year limited warranty
- 14" x 9" x 15" / 10 lbs
- Uses: 1765016 bags, 1760049 oil

EX12-05 Super Cross Cut Personal Shredder

ITEM NO.
GBC1757390

\$394⁰⁰



- 9" throat width, 1 user
- 12 sheet capacity, 10 fpm
- 5/32" x 1-1/2" shred size
- Security level P-4
- Shreds staples, clips, CCs, CDs
- 5 gallon basket w/window
- Separate CD slot & waste bin
- Illuminated status symbols
- Auto on/off, reverse mode
- 2 year limited warranty
- 9" x 17" x 16" / 17 lbs
- Uses: 1765016 bags, 1760049 oil

EX10-06 Jam Free Cross Cut Shredder

ITEM NO.
GBC1757392

\$524⁰⁰



- 9" throat width, 1-2 users
- 10 sheet capacity, 7 fpm
- 1/4" x 2" shred size
- Security level P-3
- Shreds staples, clips, CCs
- 6 gallon pullout bin w/window
- Non-stop Jam Free Technology
- Illuminated status symbols
- Auto power save & wake-up
- Self-cleaning cutters, quiet
- 2 year limited warranty
- 11" x 19" x 16" / 29 lbs
- Uses: 1765016 bags, 1760049 oil

EX14-06 Super Cross Cut Personal Shredder

ITEM NO.
GBC1757398

\$499⁰⁰



- 9" throat width, 1-2 users
- 14 sheet capacity, 10 fpm
- 5/32" x 1-1/2" shred size
- Security level P-4
- Shreds staples, clips, CCs, CDs
- 6 gallon basket w/window
- Non-stop Jam Free Technology
- Illuminated status symbols
- Auto power save & wake-up
- Self-cleaning cutters, quiet
- 2 year limited warranty
- 10" x 18" x 16" / 28 lbs
- Uses: 1765016 bags, 1760049 oil

Style+ Super Cross Cut Personal Shredder

ITEM NO.
GBC1758581

\$230⁹⁹



- 9" throat width, 1 user
- 7 sheet capacity, 9 fpm
- 1/4" x 1" shred size
- Security level P-4
- Shreds staples, clips, CCs
- 3.3 gallon pullout drawer
- Auto on/off, reverse mode
- 2 year limited warranty
- 8" x 15" x 14" / 13 lbs
- Uses: 1765016 bags, 1760049 oil

SX15-06 Super Cross Cut Small Office Shredder

ITEM NO.
GBC1758500

\$455⁹⁹



- 9" throat width, 1-2 users
- 15 sheet capacity, 2 hr run
- 5/32" x 1-1/2" shred size
- Security level P-4
- Shreds staples, paper clips
- 6 gallon pullout bin/window
- Whisper Shred Technology
- User friendly touch controls
- LED indicators for bin full, door open, overheat/load
- Automatic reverse on jam
- Eco Power Save function
- 2 year limited warranty
- 16.7" x 14.6" x 11.4" / 35 lbs

SM10-06 Micro Cut Home Office Shredder

ITEM NO.
GBC1758499

\$502⁹⁹



- 9" throat width, 1-2 users
- 10 sheet capacity, 2 hr rt
- 1/8" x 1/2" particles
- Security level P-5
- Shreds staples, paper clips
- 6 gallon pullout bin/window
- Whisper Shred Technology
- User friendly touch controls
- LED indicators for bin full, door open, overheat/load
- Automatic jam reverse, alert
- Eco Power Save function
- 2 year limited warranty
- 19.7" x 14.6" x 11.4" / 37.5 lbs

SX20-08 Super Cross Cut Small Office Shredder

ITEM NO.
GBC1758502

\$798⁴⁰



- 9" throat width, 1-5 users
- 20 sheet capacity, 4 hr run
- 5/32" x 1-1/2" shred size
- Security level P-4
- Shreds staples, paper clips
- 8 gallon pullout bin/window
- Whisper Shred Technology
- User friendly touch controls
- LED indicators for bin full, door open, overheat/load
- Automatic jam reverse, alert
- Eco Power Save function
- 2 year limited warranty
- 23.5" x 16" x 12.5" / 42.9 lbs

SM15-08 Micro Cut Small Office Shredder

ITEM NO.
GBC1758501

\$726⁹⁹



- 9" throat width, 1-5 users
- 15 sheet capacity, 4 hr rt
- 1/8" x 1/2" particles
- High security level P-5
- Shreds staples, paper clips
- 8 gallon pullout bin/window
- Whisper Shred Technology
- User friendly touch controls
- LED indicators for bin full, door open, overheat/load
- Automatic jam reverse, alert
- Eco Power Save function
- 2 year limited warranty
- 23.5" x 16" x 12.5" / 52.9 lbs

SX19-09 Jam Free Super Cross Cut Shredder

ITEM NO.
GBC1758493

\$798⁴⁰



- 9" throat width, 1-5 users
- 19 sheet capacity
- 3/16" x 1-1/2" shred size
- Security level P-4
- Shreds staples, clips, CCs, CDs
- 9 gallon pullout drawer
- Non-stop Jam Free Technology
- Illuminated status symbols
- Auto power save & wake-up
- Self-cleaning cutters, castor
- 2 year limited warranty
- 14" x 12" x 24" / 39 lbs
- Uses: 1765016 bags, 1760049 oil

SM12-08 Jam Free Micro Cut Shredder

ITEM NO.
GBC1758496

\$1,057⁹⁹



- 9" throat width, 1-5 users
- 11 sheet capacity, 7 fpm
- 5/64" x 5/8" shred size
- Security level P-5
- Shreds staples, clips, CCs
- 8 gallon pullout drawer
- Non-stop Jam Free Technology
- Illuminated status symbols
- Auto power save & wake-up
- Self-cleaning cutters, castors
- 2 year limited warranty
- 17" x 13" x 22" / 39 lbs
- Uses: 1765016 bags, 1760049 oil

SX16-08 Jam Free Cross Cut Shredder

ITEM NO.
GBC1758495

\$866⁹⁹



- 9" throat width, 1-5 users
- 16 sheet capacity, 7 fpm
- 5/32" x 1-3/4" P-3 shred size
- Runtime 20 min on / 10 off
- Shreds staples, clips, CCs, DVDs
- 8 gallon pullout bin/window
- Non-stop Jam Free Technology
- Illuminated status symbols
- Auto power save & wake-up
- Intelligent Self-Cleaning cutters
- Ultra-quiet operation, castors
- 2 year warranty, 10 on cutters
- 22" x 17" x 13" / 39 lbs
- Uses: 1765016 bags, 1760049 oil

Call Your Sales Representative Today

DS22-13 Jam Free Strip Cut Shredder

ITEM NO.
GBC1758575

\$1,430⁹⁹



- 10" throat width, 5-10 users
- 22 sheet capacity, 16 fpm
- 1/4" shred size
- Security level P-2
- Shreds staples, clips, CCs, CDs
- 13 gallon wire frame bin
- Non-stop Jam Free Technology

- Auto power save & wake-up
- Continuous duty, quiet, castors
- 2 year limited warranty
- 19" x 14" x 24" / 52 lbs
- Uses: GBC1760049 oil
- Uses: FEL1765010 bags

DX18-13 Jam Free Cross Cut Shredder

ITEM NO.
GBC1758585

\$1,565⁹⁹



- 10" throat width, 5-10 users
- 18 sheet capacity, 16 fpm
- 5/32" x 1-3/4" shred size
- Security level P-3
- Shreds staples, clips, CCs, CDs
- 13 gallon wire frame bin
- Non-stop Jam Free Technology
- Auto power save & wake-up

- Self clean and SelfOil™
- Continuous duty, quiet, castors
- 2 year limited warranty
- 19" x 16" x 24" / 62 lbs
- Uses: GBC1760049 oil
- Uses: FEL1765010 bags

DS22-19 Jam Free Strip Cut Shredder

ITEM NO.
GBC1758595

\$1,662⁹⁹



- 10" throat width, 10-20 users
- 22 sheet capacity, 16 fpm
- 1/4" shred size
- Security level P-2
- Shreds staples, clips, CCs, CDs
- 19 gallon wire frame bin
- Non-stop Jam Free technology

- Auto power save & wake-up
- Continuous duty, quiet, castors
- 2 year limited warranty
- 19" x 16" x 30" / 57 lbs
- Uses: GBC1760049 oil
- Uses: FEL1765010 bags

DX20-19 Jam Free Cross Cut Shredder

ITEM NO.
GBC1758605

\$1,983⁹⁹



- 10" throat width, 10-20 users
- 20 sheet capacity, 16 fpm
- 5/32" x 1-3/4" shred size
- Security level P-3
- Shreds staples, clips, CCs, CDs
- 19 gallon wire frame bin
- Non-stop Jam Free technology

- Auto power save & wake-up
- Self clean and SelfOil™
- Continuous duty, quiet, castors
- 2 year limited warranty
- 19" x 16" x 30" / 70 lbs
- Uses: GBC1760049 oil
- Uses: FEL1765010 bags

DM12-13 Jam Free Micro Cut Shredder

ITEM NO.
GBC1770070

\$2,535⁹⁹



- 10" throat width, 5-10 users
- 12 sheet capacity, 15 fpm
- 1/8" x 1/2" shred size
- Security level P-5
- Shreds staples, clips, CCs
- 13 gallon wire frame bin
- Non-stop Jam Free Technology

- Auto power save & wake-up
- Self clean and SelfOil™
- Continuous duty, quiet, castors
- 2 year warranty w/on-site service
- 19" x 14" x 24" / 71 lbs
- Uses: GBC1760049 oil
- Uses: FEL1765010 bags

LS32-30 Jam Free Strip Cut Shredder

ITEM NO.
GBC1770035

\$3,692⁹⁹



- 10" throat width, 20+ users
- 32 sheet capacity, 21 fpm
- 1/4" shred size
- Security level P-2
- Shreds staples, clips, CCs, CDs
- 30 gallon wire frame bin
- Non-stop Jam Free Technology

- Auto power save & wake-up
- SelfOil™ extends cutter life
- Continuous duty, quiet, castors
- 2 year warranty w/on-site service
- 27" x 26" x 41" / 147 lbs
- Uses: GBC1760049 oil
- 1765015 or 1765021 bags

LM12-30 Jam Free Micro Cut Shredder

ITEM NO.
GBC1770055

\$5,125⁹⁹

- 10" throat width, 20+ users
- 12 sheet capacity, 18 fpm
- 1/8" x 1/2" shred size
- Security level P-5
- Shreds staples, clips, CCs, CDs

- 30 gallon wire frame bin
- Non-stop Jam Free Technology
- Auto power save & wake-up
- Self clean and SelfOil™
- Continuous duty, quiet, castors

- 2 year warranty w/on-site service
- 27" x 26" x 41" / 161 lbs
- Uses: GBC1760049 oil
- 1765015 or 1765021 bags



CS30-36 Strip Cut Commercial Shredder

ITEM NO.
GBC1753280

\$4,399⁹⁹



- 12" throat width, 20+ users
- 30 sheet capacity, 18 fpm
- 3/16" shred size
- Security level P-2
- Shreds staples, clips, CCs, CDs
- 36 gallon pullout bin
- JamStopper protection
- Auto power save & wake-up

- Continuous duty, quiet, castors
- TAA Compliant, German made
- 2 year warranty w/on-site service
- 21" x 18.5" x 36.5" / 133 lbs
- Uses: 1145482 bags, 1760049 oil

GBC1753270 (CX25-36 Cross Cut, P-4) **\$4,739.99**

CM15-30 Micro Cut Commercial Shredder

ITEM NO.
GBC1753300

\$4,666⁹⁹



- 10" throat width, 20+ users
- 15 sheet capacity, 18 fpm
- 3/32" x 5/8" shred size
- Security level P-5
- Shreds staples, clips, CCs, CDs
- 30 gallon pullout bin
- JamStopper protection
- Auto power save & wake-up

- Continuous duty, quiet, castors
- TAA Compliant, German made
- 1 year warranty w/on-site service
- 19.5" x 18.5" x 36.5" / 122 lbs
- Uses: 1145482 bags, 1760049 oil

GBC1753290 (CHS10-30 High Security, P-7) **\$8,556.99**

CX22-44 Cross Cut Commercial Shredder

ITEM NO.
GBC1758582

\$5,115⁹⁹



- 15" throat width, 20+ users
- 22 sheet capacity, 20 fpm
- 3/16" x 1-1/2" shred size
- Security level P-3
- Shreds staples, clips, CCs, CDs
- Large 44 gallon pullout bin
- JamStopper protection

- Illuminated status symbols
- Continuous duty, quiet, castors
- TAA Compliant, German made
- 2 year warranty w/on-site service
- 24" x 18.5" x 37.5" / 171 lbs
- Uses: 1145482 bags, 1760049 oil

CX30-55 Cross Cut Commercial Shredder

ITEM NO.
GBC1758583

\$6,844⁹⁹



- 16" throat width, 20+ users
- 30 sheet capacity, 20 fpm
- 3/16" x 1-1/2" shred size
- Security level P-3
- Shreds staples, clips, CCs, CDs
- Large 55 gallon pullout bin
- JamStopper protection
- Illuminated status symbols

- Auto power save & wake-up
- Continuous duty, quiet, castors
- Requires a 20 Amp outlet
- TAA Compliant, German made
- 2 year warranty w/on-site service
- 25" x 23" x 38" / 239 lbs
- Uses: 1145482 bags, 1760049 oil

GBCNGLINE ACCESSORIES

Item Code	Size	Fits Machine Model	Qty	List
Plastic Bags				
GBC1765016	6-8 gallons	Style+, 60x, 80x, 130x, 130m, EX, EM, PS, PX, SX, SM Series	100	\$66.50
GBC1765010	13-19 gallons	30x, 300x, 300m, DS, DX, DM Series	25	\$33.99
GBC1765015	30 gallons	600x, 600m, 750x, 750m, CHS, L Series	25	\$39.99
GBC1145482	35-60 gallons	CS, CX, CM Series	100	\$127.99
Recyclable Paper Bags				
GBC1765021	30 gallons	L Series	50	\$335.99
GBC1760049	16 oz bottle	Shredder oil for all models	1	\$39.99
GBC1753190	33 oz bottle	Shredder oil for CHS model	1	\$91.50

Call Your Sales Representative Today

Savings Without Risk

Toner for all of today's top-selling OEM printers ...from Xerox.

Toner usually comes in one of two extremes. Expensive. Or unreliable. Not anymore.

Xerox® Everyday™ Toner is a new line of toner supplies for non-Xerox® printers that takes a different approach. No exorbitant prices. No hidden costs. Just the confidence of the Xerox brand and solid performance you've come to trust.

NO RISK LIFETIME WARRANTY

Unlike no-name bargain brands, Xerox® Everyday™ Toner comes with a lifetime warranty. Should a problem ever arise, your distributor will facilitate a no-hassle exchange.



SUPERIOR VALUE. FOR MUCH LESS.

Trust your toner business to a brand that customers recognize for quality, reliability, and overall product performance. Xerox® Everyday™ Toner is truly a risk-free option to costlier OEM cartridges and the safest alternative to no-name bargain brands.



xerox™

PRODUCT SAFETY, SUSTAINABILITY & QUALITY



REACH



RoHS



WEEE



ISO 14001:
2015



ISO 9001:
2015

shredstar X5 *Cross Cut Home Office Shredder*

ITEM NO.
HSM1043w

\$146⁰⁰



- 8.7" throat width
- 5 sheet capacity, 8.27 fpm
- 3/16" x 1 1/8" shred size
- Security level P-4
- Shreds staples, clips, CCs, CDs
- Separate CD slot & waste bin

- 4.8 gallon basket w/window
- Automatic start / stop
- Auto reverse, quiet operation
- LED status indicator
- 2 year parts warranty
- Lifetime on cutting rollers
- 17.5" x 13.6" x 9.6" / 9.6 lbs

shredstar S25 *Strip Cut Home Office Shredder*

ITEM NO.
HSM1031w

\$736⁰⁰



- 9.1" throat width
- 25 sheet capacity, 8.86 fpm
- 1/4" shred size
- Security level P-2
- Shreds staples, clips, CCs, CDs
- Separate CD slot & waste bin
- 6.9 gallon basket w/window

- Automatic start / stop
- Auto reverse, quiet operation
- LED status indicator
- 2 year parts warranty
- Lifetime on cutting rollers
- 21.7" x 15.6" x 11" / 26.5 lbs

Shredstar X8 (Cross, 8 sheet)	\$220.00
Shredstar X10 (Cross, 10 sheet)	\$312.00
shredstar X12 (Cross, 12 sheet)	\$506.00
shredstar X14 (Cross, 14 sheet)	\$674.00
shredstar X17 (Cross 17 sheet)	\$746.00
shredstar X20 (Cross, 20 sheet)	\$719.00

Pure 420c *Cross Cut Home Office Shredder*

ITEM NO.
HSM2343

\$1,417⁰⁰



- 9.5" throat width
- 14-16 sheet capacity, 12.8 fpm
- 3/16" x 1-1/8" shred size
- Security level P-4
- Shreds staples, clips, CCs, CDs
- Separate CD slot & waste bin
- 9.2 gallon basket w/window

- Automatic start / stop
- Auto reverse, quiet operation
- LED status indicator
- 2 year parts warranty
- Lifetime on cutting rollers
- 24.5" x 15.6" x 11.5" / 40 lbs

HSM2341 (Strip, 22-24 sheets).....**\$1,177.00**

Pure 530c *Cross Cut Office Shredder*

ITEM NO.
HSM2353

\$2,157⁰⁰



- 11.8" throat width, 1-6 users
- 16-18 sheet capacity, 12.8 fpm
- 3/16" x 1 1/8" shred size
- Security level P-4
- Shreds staples, clips, CCs, CDs
- 21 gallon basket
- Made in Germany

- Automatic start / stop
- Safety system, quiet operation
- Continuous duty, Anti-Jam
- 2 year parts warranty
- Lifetime on cutting rollers
- 28" x 19.5" x 14.25" / 65 lbs
- Uses: 1815 bags, 314 oil

HSM2351 (Strip, 28-30 sheets)**\$2,101.00**

Pure 630c *Cross Cut Large Office Shredder*

ITEM NO.
HSM2363

\$3,447⁰⁰



- 11.8" throat width
- 25-27 sheet capacity, 17 fpm
- 3/16" x 1 1/8" shred size
- Security level P-4
- Shreds staples, clips, CCs, CDs
- 34.3 gallon basket
- Made in Germany

- Automatic start / stop
- Safety system, quiet operation
- Continuous duty, Anti-Jam
- 2 year parts warranty
- Lifetime on cutting rollers
- 35" x 24.4" x 19" / 119 lbs
- Uses: 1815 bags, 314 oil

HSM2361WG (Strip, white glove service)**\$2,848.00**

Pure 740c *Cross Cut Office Shredder*

ITEM NO.
HSM2373

\$4,679⁰⁰



- 15.7" throat width, 6-11 users
- 25-27 sheet capacity, 21.65 fpm
- 3/16" x 1 1/8" shred size
- Security level P-4
- Shreds staples, clips, CCs, CDs
- 38.3 gallon basket
- Made in Germany

- Automatic start / stop
- Safety system, quiet operation
- Continuous duty, Anti-Jam
- 2 year parts warranty
- Lifetime on cutting rollers
- 35" x 24.4" x 19" / 119 lbs
- Uses: 2117 bags, 314 oil

HSM2371 (Strip, 40-42 sheets)**\$4,096.00**

Pure 830c *Cross Cut Large Office Shredder*

ITEM NO.
HSM2383

\$10,392⁰⁰



- 12.9" throat width
- 39-41 sheet capacity, 21.65 fpm
- 3/16" x 1 1/8" shred size
- Security level P-4
- Shreds staples, clips, CCs, CDs
- 39.6 gallon basket
- Made in Germany

- Automatic start / stop
- Safety system, quiet operation
- Continuous duty, Anti-Jam
- 2 year parts warranty
- Lifetime on cutting rollers
- 37.5" x 22.7" x 21.5" / 148 lbs
- Uses: 2117 bags, 314 oil

HSM2380 (Strip, 47-49 sheets)**\$8,006.00**

Call Your Sales Representative Today

SECURIO B22c

Cross Cut Office Shredder

ITEM NO.
HSM1833

\$1,335⁰⁰

- 9.4" throat width
- 16 sheet capacity, 17.72 fpm
- 1/8" x 1 1/8" shred size
- Security level P-4
- Shreds staples, clips, CCs, CDs
- 8.7 gallon basket w/window
- Blue Angel certified

- Made in Germany
- Safety system, quiet operation
- Continuous duty, Anti-Jam
- 3 year parts warranty
- Lifetime on cutting rollers
- 23.6" x 14.8" x 12.2" / 28.6 lbs
- Uses: 1310 bags, 314 oil



HSM1831 (Strip, 14-24 sheets) **\$1,106.00**

SECURIO B26c

Cross Cut Office Shredder

ITEM NO.
HSM1803

\$1,985⁰⁰

- 11" throat width, 1-6 users
- 17-19 sheet capacity, 13 fpm
- 3/16" x 1 1/8" shred size
- Security level P-4
- Shreds staples, clips, CCs, CDs
- 14.5 gallon basket w/window
- Blue Angel certified
- Made in Germany

- Safety system, quiet operation
- Continuous duty, Anti-Jam
- 3 year parts warranty
- Lifetime on cutting rollers
- 26.6" x 19.6" x 15.6" / 58.2 lbs
- Uses: 1815 bags, 314 oil



HSM1801 (Strip, 28-30 sheets) **\$1,701.00**

SECURIO B35c

Cross Cut Large Office Shredder

ITEM NO.
HSM1923

\$4,759⁰⁰

- 15.75" throat width, 1-8 users
- 24-26 sheet capacity, 17.32 fpm
- 3/16" x 1 1/8" shred size
- Security level P-4
- Shreds staples, clips, CCs, CDs
- 34.3 gallon basket w/window
- Blue Angel certified
- Made in Germany

- Safety system, quiet operation
- Continuous duty, Anti-Jam
- 3 year parts warranty
- Lifetime on cutting rollers
- 34.25" x 24.3" x 20.67" / 120 lbs
- Uses: 2117 bags, 314 oil



HSM1921 (Strip, 40-42 sheets) **\$3,954.00**

SECURIO P36ic

Cross Cut Large Office Shredder

ITEM NO.
HSM1853

\$9,379⁰⁰

- 13" throat width
- 147-49 sheet capacity, 18 fpm
- 3/16" x 1 1/8" shred size
- Security level P-4
- Shreds staples, clips, CCs, CDs
- 38.3 gallon basket w/window
- Blue Angel certified

- Made in Germany
- Continuous duty, Anti-Jam
- 3 year parts warranty
- Lifetime on cutting rollers
- 40.16" x 22.8" x 21.7" / 150 lbs
- Uses: 2117 bags, 314 oil



HSM1851 (Strip, 47-49 sheets) **\$6,972.00**

SECURIO AF150c

Auto Feed Office Shredder

ITEM NO.
HSM2083

\$2,063⁰⁰

- 9.5" throat width
- 150 page stack capacity,
- 17-19 sheet manual, 12.8 fpm
- 3/16" x 1 1/8" shred size
- Security level P-4
- Shreds staples, clips, CCs, CDs
- 9 gallon basket w/window

- Blue Angel certified
- Made in Germany
- Continuous duty, Anti-Jam
- 3 year parts warranty
- Lifetime on cutting rollers
- 29.13" x 15.5" x 15" / 43.2 lbs
- Uses: 1408 bags, 314 oil



HSM ACCESSORIES

Item Code	Size	Fits Machine Model	Qty	List
HSM1310	11 gallon bags	B22, 120, 220, 320, 420 shredders	100	\$75.10
HSM1408	13 gallon bags	B24, AF150, AF300	100	\$68.14
HSM1815	34 gallon bags	B26, B32, B34, AF500, 530, 125.2	100	\$92.18
HSM2117	58 gallon bags	B35, P36i, P40i, 630, 740, 830, 225.2, 390.3, 411.2	100	\$212.16
HSM2523	96 gallon bags	P44i, 450.2, 1049SA	50	\$216.96
HSM316	12 ounce bottle	Shredder oil for all models	1	\$36.93
HSM316P	12 ounce bottles	Shredder oil for all models	6	\$221.58
HSM314	16 ounce bottle	Shredder oil for all models	1	\$44.52
HSM314P	16 ounce bottles	Shredder oil for all models	12	\$534.22
HSM315	1 gallon bottle	Shredder oil for all models	1	\$55.01
HSM315P	1 gallon bottles	Shredder oil for all models	4	\$220.05

SECURIO AF500c

Auto Feed Office Shredder

ITEM NO.
HSM2103

\$3,441⁰⁰

- 9.5" throat width
- 500 page stack capacity,
- 17-19 sheet manual, 12.8 fpm
- 3/16" x 1 1/8" shred size
- Security level P-4
- Shreds staples, clips, CCs, CDs
- 21.7 gallon basket w/window
- Blue Angel certified

- Made in Germany
- Lock-and-Go function
- Continuous duty, Anti-Jam
- 3 year parts warranty
- Lifetime on cutting rollers
- 39.5" x 19.6" x 19.3" / 60 lbs
- Uses: 1815 bags, 314 oil



SECURIO AF300c (300 sheet) **\$2,098.00**

2270cc Destroyit® Cross Cut
Desktop Shredder

ITEM NO.
MBM2270CC

\$539⁰⁰

- 8.75" throat width
- 5-6 sheet capacity, 12 fpm
- 1/8" x 1" shred size
- Security level P-4
- Shreds staples, clips, CCs, CDs
- 5 gallon paper bin w/window
- Separate cut head/bin for CDs

- Transparent safety shield
- High quality wood cabinet
- 3 yr part, 90 day labor warranty
- Lifetime on cutting shafts
- 13.5" x 8.8" x 21" / 32 lbs
- Uses: 907 bags, CED214 oil



MBM2270SC (Strip Cut, P-2).....**\$439.00**

2445cc Destroyit® Cross Cut
Desktop Shredder

ITEM NO.
MBM2445CC

\$1,249⁰⁰

- 9.5" throat width
- 6-8 sheet capacity
- 3/32" x 5/8" shred size
- Security level P-5
- Shreds staples, clips, CCs
- 9 gallon shred volume

- Safety Protection System®
- Zero Consumption Sleep Mode
- 3 yr part, 90 day labor warranty
- Lifetime on cutting shafts
- 15.5" x 11.8" x 25" / 53 lbs
- Uses: 908 bags, CED214 oil



MBM2445SC (Strip Cut, P-2).....**\$1,089.00**

2465cc Destroyit® Cross Cut
Desktop Shredder

ITEM NO.
MBM2465CC

\$1,719⁰⁰

- 9.5" throat width
- 9-11 sheet capacity, 27 fpm
- 3/32" x 5/8" shred size
- Security level P-5
- Shreds staples, clips, CCs
- 13 gallon shred volume
- Safety Protection System®

- Zero Consumption Sleep Mode
- 3 yr part, 90 day labor warranty
- Lifetime on cutting shafts
- 15.5" x 11.8" x 28.8" / 58 lbs
- Uses: 908 bags, CED214 oil



MBM2465SC (Strip Cut, P-2).....**\$1,479.00**

2503cc Destroyit® Cross Cut Centralized
Office Shredder

ITEM NO.
MBM2503CC

\$2,229⁰⁰

- 10.25" throat width
- 12-14 sheet capacity, 24 fpm
- 3/16" x 1-1/2" shred size
- Security level P-4
- Shreds staples, clips, CCs
- 26 gallon shred volume
- Safety Protection System®

- Zero Consumption Sleep Mode
- Auto reverse, power cut-off
- 3 yr part, 90 day labor warranty
- Lifetime on cutting shafts
- 19.8" x 14.8" x 34" / 78 lbs
- Uses: 920 bags, CED214 oil



MBM2503SC (Strip Cut, P-2)**\$1,999.00**

2604cc Destroyit® Cross Cut Centralized
Office Shredder

ITEM NO.
MBM2604CC

\$2,999⁰⁰

- 10.25" throat width
- 23-25 sheet capacity, 18 fpm
- 3/16" x 1-1/2" shred size
- Security level P-4
- Shreds staples, clips, CCs, CDs
- 26 gallon shred volume
- Automatic oil injection
- Safety Protection System®

- Electronic Capacity Control
- Zero Consumption Sleep Mode
- 3 yr part, 90 day labor warranty
- Lifetime on cutting shafts
- 19.5" x 18.5" x 36.5" / 123 lbs
- Uses: 920 bags, CED216 oil



MBM2604SC (Strip Cut, P-2).....**\$2,619.00**

3104cc Destroyit® Cross Cut Centralized
Office Shredder

ITEM NO.
MBM3104CC

\$3,559⁰⁰

- 12" throat width
- 22-25 sheet capacity, 18 fpm
- 3/16" x 1-1/2" shred size
- Security level P-4
- Shreds staples, clips, CCs, CDs
- 32 gallon shred volume
- Safety Protection System®

- Electronic Capacity Control
- Zero Consumption Sleep Mode
- 3 yr part, 90 day labor warranty
- Lifetime on cutting shafts
- 21" x 18.5" x 36.5" / 132 lbs
- Uses: 920 bags, CED214 oil



MBM3104SC (Strip Cut, P-2)**\$3,079.00**

3804cc Destroyit® Cross Cut Centralized
Office Shredder

ITEM NO.
MBM3804CC

\$4,449⁰⁰

- 16" throat width
- 24-26 sheet capacity, 20 fpm
- 3/16" x 1-1/2" shred size
- Security level P-4
- Shreds staples, clips, CCs, CDs
- 44 gallon pullout bin
- Safety Protection System®

- Electronic Capacity Control
- Zero Consumption Sleep Mode
- 3 yr part, 90 day labor warranty
- Lifetime on cutting shafts
- 25" x 23" x 38" / 233 lbs
- Uses: 918 bags, CED214 oil



MBM3804SC (Strip Cut, P-2)**\$3,979.00**

4002cc Destroyit® Cross Cut Centralized
Office Shredder

ITEM NO.
MBM4002CC

\$4,999⁰⁰

- 16" throat width
- 24-26 sheet capacity, 25 fpm
- 3/16" x 1-1/2" shred size
- Security level P-4
- Shreds staples, clips, CCs, CDs
- 44 gallon pullout bin
- Automatic oil injection
- Safety Protection System®

- Electronic Capacity Control
- Zero Consumption Sleep Mode
- 3 yr part, 90 day labor warranty
- Lifetime on cutting shafts
- 25" x 23" x 38" / 240 lbs
- Uses: 901 bags, CED214 oil



MBM4002SC (Strip Cut, P-2)**\$4,449.00**

Call Your Sales Representative Today

3105cc Destroyit® Cross Cut Centralized Office Shredder

ITEM NO.
MBM3105CC

\$8,079⁰⁰



- 12" throat width
- 37-39 sheet capacity, 30 fpm
- 3/16" x 1-1/2" shred size
- Security level P-4
- Shreds staples, clips, CCs, CDs
- 36 gallon pullout bin
- Automatic oil injection
- Safety Protection System®

- Electronic Capacity Control
- Zero Consumption Sleep Mode
- 3 yr part, 90 day labor warranty
- Lifetime on cutting shafts
- 22" x 23" x 40" / 324 lbs
- Uses: 918 bags, CED216 oil

4005cc Destroyit® Cross Cut Centralized Office Shredder

ITEM NO.
MBM4005CC

\$9,499⁰⁰



- 16" throat width
- 30-32 sheet capacity, 30 fpm
- 3/16" x 1-1/2" shred size
- Security level P-4
- Shreds staples, clips, CCs, CDs
- 44 gallon pullout bin
- Automatic oil injection

- Safety Protection System®
- Zero Consumption Sleep Mode
- 3 yr part, 90 day labor warranty
- Lifetime on cutting shafts
- 25" x 23" x 39.8" / 378 lbs
- Uses: 918 bags, CED216 oil

MBM4005SC (Strip Cut, P-2) **\$8,249.00**

MBM ACCESSORIES

Item Code	Size	Fits Machine Model	Qty	List
MBM907	7 gallons	2245, 2265, 2270 Series	180	\$109.00
MBM908	12 gallons	2360, 2403, 2404, 2465 Series	180	\$109.00
MBM902	25 gallons	2501, 2600, 2601, 3801 Series	80	\$159.00
MBM917	31 gallons	3800, 3802, 4001, 4203 Series	80	\$159.00
MBM920	40 gallons	2503, 2604, 3104 Series	80	\$169.00
MBM901	56 gallons	4002, 4202 Series	80	\$179.00
MBM914	60 gallons	4104, 4105 Series	80	\$239.00
MBM915	65 gallons	4105cc, 4106	40	\$239.00
MBM922	65 gallons	4107, 4109 Series	80	\$289.00
MBM923	75 gallons	5009 Series	40	\$239.00
MBM919	88 gallons	4000ss (extra large)	80	\$269.00
MBMCED214	Pint bottles	Shredder oil for all models	4	\$69.00
MBMACCED21/8	Pint bottles	Shredder oil for all models	8	\$99.00
MBMCED216	Quart bottles	Shredder oil for automatic oilers	6	\$129.00
MBMACCED21/G	Gallon bottles	Shredder oil for various models	4	\$229.00

M&M Plain 42oz Resealable Bag Plain M&M's

ITEM NO.
M&M PLN

\$15⁹⁵



M&M Peanut 42oz Resealable Bag Peanut M&M's

ITEM NO.
M&M PNT

\$15⁹⁵



JS55 Strip Cut Personal Shredder

ITEM NO.
ADLJS55

\$39⁹⁹



- 9" throat width
- 6 sheet capacity
- 1/4" shred size
- Security level P-2
- Shreds paper and staples

- 2.5 gallon bin w/lift-off head
- Auto start/stop and reverse
- 1 year parts & labor warranty
- 11.5" x 5.5" x 12.5" / 8 lbs

CX6 Cross Cut Personal Shredder

ITEM NO.
ADLCX6

\$59⁹⁹



- 8.75" throat width
- 6 sheet capacity
- 5/32" x 1-5/8" shred size
- Security level P-3
- Shreds paper and staples

- 2.5 gallon bin w/lift-off head
- Auto start/stop and reverse
- 1 year parts & labor warranty
- 13" x 5" x 13" / 6 lbs

CX8 Personal Cross Cut Shredder

ITEM NO.
ADLCX8

\$59⁹⁹



- 8.9" throat width
- 8 sheet capacity
- 5/32" x 1-1/4" shred size
- Security level P-3
- Shreds staples and CCs
- 3 gallon bin w/lift-off top

- Auto start/stop and reverse
- 1 year limited warranty
- 12.3" x 11.3" x 5.3" / 4.8 lbs

CX10 Personal Cross Cut Shredder

ITEM NO.
ADLCX10

\$69⁹⁹



- 8.9" throat width
- 10 sheet capacity
- 5/32" x 1-1/4" shred size
- Security level P-4
- Shreds staples and CCs
- 3.5 gallon bin w/window

- Lift-off head for easy empty
- Auto start/stop and reverse
- 1 year limited warranty
- 13.5" x 11.5" x 5.6" / 6.8 lbs

ST80X Cross Cut Personal Shredder

ITEM NO.
ADLST80X

\$79⁹⁹



- 9" throat width
- 8 sheet capacity
- 5/32" x 1-1/8" shred size
- Security level P-3
- Shreds staples, credit cards
- 3.2 gallon pullout basket

- Easy view translucent bin
- Sliding protective top
- Auto start/stop and reverse
- 1 year parts & labor warranty
- 12.5" x 6.5" x 15" / 9 lbs

MC500 Micro Cut Personal Shredder

ITEM NO.
ADLMC500

\$89⁹⁹



- 9" throat width
- 5 sheet capacity
- 4mm x 10mm shred size
- Security level P-4
- Shreds staples, credit cards
- 4.5 gallon bin w/lift-off head

- Easy view basket window
- Auto start/stop and reverse
- 1 year parts & labor warranty
- 12.5" x 6.8" x 13.3" / 8 lbs

CX100X Cross Cut Home Office Shredder

ITEM NO.
ADLCX100X

\$99⁹⁹



- 9" throat width
- 10 sheet capacity
- 5/32" x 1-5/8" shred size
- Security level P-4

- Shreds staples, CCs, CDs
- 3.5 gallon bin w/window
- Lift-off head for easy empty
- Auto start/stop and reverse

- 1 year limited warranty
- 13.5" x 11.5" x 5.6" / 6.8 lbs

Call Your Sales Representative Today

CX112X Cross Cut Office Shredder

ITEM NO.
ADLCX112X

\$99⁹⁹ 



- 9" throat width
- 12 sheet capacity
- 5/32" x 1-5/8" shred size
- Security level P-4
- Shreds staples, CCs, CDs
- 3.5 gallon bin w/window

- Auto start/stop and reverse
- Locking castors for mobility
- 1 year limited warranty
- 16.5" x 12.5" x 7.6" / 15 lbs

PX1201 Cross Cut Office Shredder

ITEM NO.
ADL29127H

\$129⁹⁹ 



- 8.9" throat width
- 12 sheet capacity
- 5/32" x 1-1/4" shred size
- Security level P-4
- Shreds staples, CCs, CDs
- 4.5 gallon pull bin w/window

- Auto start/stop w/phot sensor
- Forward and reverse buttons
- 10 min on / 30 off runtime
- 7/8 HP motor, locking casters
- 3 year cutter warranty
- 16.9" x 14.6" x 10.2" / 15.5 lbs

MC8 Micro Cut Office Shredder

ITEM NO.
ADL29349C

\$119⁹⁹



- 8.75" throat width
- 8 sheet capacity
- 4mm x 10mm shred size
- Security level P-5
- Shreds staples, CCs, CDs
- 3.75 gallon pull bin w/window

- Auto start/stop and reverse
- 3 min on/30 min off runtime
- 1 HP motor, casters
- 3 year cutter warranty
- 17" x 12.5" x 7.8" / 15 lbs

1510MX Cross Cut Personal Shredder

ITEM NO.
ADL1510MX

\$169⁹⁹



- 8.75" throat width
- 15 sheet capacity
- 11/64" x 1-1/2" shred size
- Security level P-4
- Shreds staples, CCs, CDs
- 5.6 gallon pullout basket

- Dual view windows & handle
- Auto start/stop and reverse
- Jam free rollers, castors
- 3 yr warranty cutter & motor
- 19.5" x 13.8" x 10.5" / 18.7 lbs

ASF910 Micro Cut Shredder w/Auto Feeder

ITEM NO.
ADLASF910

\$169⁹⁹



- 8.75" throat width
- 100 page auto load capacity
- 9 sheet manual bypass
- 4.3mm x 12mm shred size
- Runtime 10 on / 30 off
- Shreds staples, credit cards

- 4.5 gallon bin with window
- Ready, overload/heat LED's
- Auto start/stop, jam clear
- Safety sensor, castors
- 3 year cutter warranty
- 20" x 14" x 8.6" / 18.3 lbs

HD1400MX Cross Cut Media Shredder

ITEM NO.
ADL89134B

\$249⁹⁹ 



- 8.75" throat width
- 14 sheet capacity, 9 fpm
- 5/32" x 1-1/2" shred size
- Security level P-4
- Shreds staples, CCs, CDs
- 6.2 gallon pull-out bin

- Stylish mesh front w/handle
- Auto start/stop and reverse
- Up to 40 minutes runtime
- Indicators, locking casters
- 1 year limited warranty
- 11.25" x 14.5" x 19.5" / 20 lbs

MC14MX Cross Cut Office Shredder

ITEM NO.
ADLMC14MX

\$269⁹⁹



- 8.75" throat width
- 14 sheet capacity, 9 fpm
- 4mm x 10mm shred size
- Security level P-4

- Shreds staples, CCs, CDs
- 8.5 gallon basket w/window
- Auto start/stop and reverse
- Overload, bin full alarms

- Jam-free rollers, quiet motor
- Interlock switch, castors
- 1 year parts & labor warranty
- 15.5" x 12.8" x 25.5" / 36 lbs

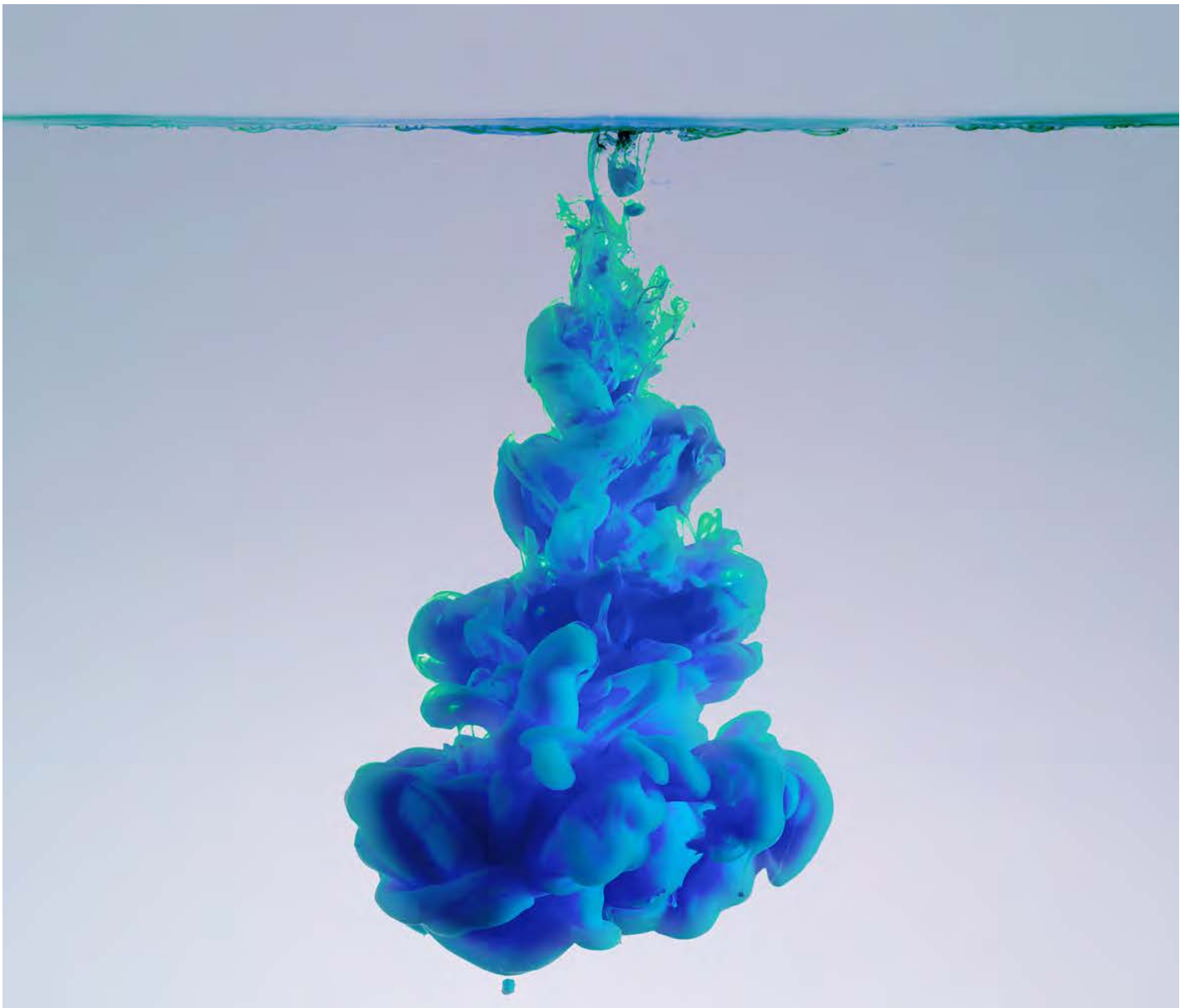

WHEN RANSOMWARE SPREADS, KEEP YOUR DATA CLEAN WITH HPE STOREEVER TAPE.

According to the FBI, ransomware targets a company every 40 seconds, making total avoidance nearly impossible. So what can you do to be prepared if ransomware starts spreading across your network? The safest approach could be to keep an offline copy of your data on LTO tape. Content stored on tape is disconnected from the network, meaning ransomware can't cross the air gap to corrupt your data. And for extra peace of mind, you can use LTO's built-in AES-256 encryption to counter against physical theft. Ransomware may be a fact but with HPE StoreEver LTO tape, you don't need to make it a reality. To learn more, visit hpe.com/storage/storeever

Accelerating next

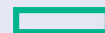

**Hewlett Packard
Enterprise**



AQ-701G Premier AquaBall Moistener

ITEM NO.
MYIAQ701G

\$26⁰⁰



- No more unsanitary sponges!
- Wet fingers for easier filing
- Stamps, labels or envelopes
- Unique floating ball design

- O-ring seal prevents splashing
- Reduces evaporation & spills
- 180 days parts & labor warranty
- 3" x 4" x 2" / 8 oz

LMS1 Premier Moistener/Sealer

ITEM NO.
MYILMS1

\$62⁰⁰



- Eliminate licking envelopes!
- Moisten & seal in single pass
- Easy-fill top access reservoir
- Fully enclosed housing
- No splashing or evaporation

- Side storage compartment
- 180 days parts & labor warranty
- 8" x 4.5" x 4" / 1.4 lbs

CL6 Manual Desktop Collator

ITEM NO.
MYICL6

\$189⁰⁰



- Stop counting/sorting by hand
- No set-up or electricity needed
- Simply pull the lever handle
- Creates up to 6 sheets sets

- Accepts letter & legal sizes
- Bins hold up to 100 sheets
- 180 days parts & labor warranty
- 11" x 13" x 9" / 5 lbs

400 Tabletop Jogger

ITEM NO.
MYI400

\$1,207⁰⁰



- Eliminates static electricity
- Reduces paper from sticking
- Prevents costly jamming
- Jogs 1 ream 8.5" x 11" paper or 1/2 ream 8.5" x 14" paper

- Fixed speed and tilted tray
- Sturdy suction cup feet
- 180 days parts & labor warranty
- 15" x 11" x 15" / 23 lbs

J1811 Jiffy Padding Press

ITEM NO.
MYIJ1811

\$367⁰⁰



- Ideal for all size print shops
- Carbonless forms & note pads
- Max stack: 17.75" w x 5.75" h
- Dual stacks at one time
- Tighten wing screws by hand
- No tools necessary

- Solid steel construction
- Secure non-skid rubber feet
- 180 days parts & labor warranty
- 19" x 11" x 13" / 18 lbs
- Uses: M-OMYJ001 glue kit

J1824 Jiffy Giant Padding Press

ITEM NO.
MYIJ1824

\$590⁰⁰



- Ideal for all size print shops
- Carbonless forms & note pads
- Max stack: 17.75" w x 19.75" h
- Rotating elevation bar
- Tip back to square paper
- Wing screws tighten by hand

- No tools necessary
- Sturdy steel construction
- 180 days parts & labor warranty
- 19" x 24" x 13" / 26 lbs
- Uses: M-OMYJ001 glue kit

J2436 Professional Padding Press

ITEM NO.
MYIJ2436

\$1,400⁰⁰



- Single-person operation
- Stable higher pivot point
- Up to 15,000 sheet capacity
- Max stack: 24" w x 30" h
- Twin doors with thumb latches

- Safe, no pinch or crush points
- Side spring-loaded tilt lever
- Deep drip tray reduces mess
- Easy clean removable doors
- Lower supply storage shelf

- Solid steel construction
- Stationary locking casters
- 180 days parts & labor warranty
- 30" x 30" x 65" / 98 lbs

Starlet™ 2+ Plastic Comb Binding Machine
*Must buy in multiples of 2

ITEM NO.
FEL5227701

\$123⁹⁹



- Light duty for personal use
- Punches up to 12 sheets
- Bind 120 sheets with 5/8" comb
- Continuous punch & bind
- Easy to use handle & loading
- Adjustable edge guide
- Comb selection guide
- Integrated storage tray
- 2 year limited warranty
- 19.5" x 8" x 5.5" / 7.5 lbs

Helios™ 30 Thermal Binding Machine

ITEM NO.
FEL5219301

\$282⁹⁹



- Fast 4 minute heat-up time
- Medium duty desktop use
- Binds up to 300 sheets
- HeatShield™ safety barrier
- Audio/visual indicators
- Manual paper measure guide
- Auto-off prevents overheating
- Folds flat for easy storage
- 2 year limited warranty
- 20.9" x 9.4" x 3.9" / 8 lbs

Star™ + Plastic Comb Binding Machine

ITEM NO.
FEL5006501

\$156⁹⁹



- Light duty for small office
- Punches up to 15 sheets
- Bind 150 sheets with 3/4" comb
- Continuous punch & bind
- Accurate vertical loading
- Adjustable edge guide
- Comb selection guide
- Integrated storage tray
- 2 year limited warranty
- 18" x 10" x 3" / 10 lbs

Helios™ 60 Thermal Binding Machine

ITEM NO.
FEL5219501

\$395⁹⁹



- Fast 4 minute heat-up time
- High performance office use
- Binds up to 600 sheets
- HeatShield™ safety barrier
- LED control panel
- Audio/visual indicators
- Auto paper thickness detector
- Auto-off prevents overheating
- Folds flat for easy storage
- 2 year limited warranty
- 20.9" x 9.4" x 3.9" / 8 lbs

Pulsar™ + Plastic Comb Binding Machine

ITEM NO.
FEL5006801

\$314⁹⁹



- For moderate office use
- Punches up to 20 sheets
- Binds 300 sheets with 1-1/2" comb
- Accurate vertical loading
- Adjustable edge guide
- Document measuring tool
- Built-in comb storage tray
- 10pk starter kit included
- 2 year limited warranty
- 18" x 15" x 5" / 15 lbs

Pulsar™ E Plastic Comb Binding Machine

ITEM NO.
FEL5216701

\$553⁹⁹



- Effortless electric operation
- Punches up to 20 sheets
- Bind 300 sheets with 1-1/2" comb
- Accurate vertical loading
- Adjustable edge guide
- Document measuring tool
- Built-in comb storage tray
- 10pk starter kit included
- 2 year limited warranty
- 17" x 15" x 5" / 21 lbs

Quasar™ + Plastic Comb Binding Machine

ITEM NO.
FEL5227201

\$468⁴⁹



- For medium-large office use
- Punches up to 25 sheets
- Bind 500 sheets with 2" comb
- Continuous punch & bind
- Accurate vertical loading
- Adjustable edge guide
- Integrated measuring tool
- Built-in comb storage tray
- 10pk starter kit included
- 2 year limited warranty
- 18" x 15" x 5" / 16.5 lbs

Galaxy™ Plastic Comb Binding Machine

ITEM NO.
FEL5218201

\$782⁹⁹



- Heavy duty for frequent use
- Punches up to 28 sheets
- Binds 500 sheets with 2" comb
- Removable bind mechanism
- Accurate vertical loading
- Adjustable edge guide
- Integrated measuring tool
- Comb storage & waste tray
- 20pk starter kit included
- 2 year limited warranty
- 20.9" x 17.8" x 6.5" / 23 lbs

FEL5216901 (QuasarE, electric, 25 sheets)**\$725.99**

FEL5218301 (GalaxyE, electric, 28 sheets)**\$1,014.99**

Call Your Sales Representative Today

Quasar™ W Wire Binding Machine

ITEM NO.
FEL5217401

\$545⁹⁹

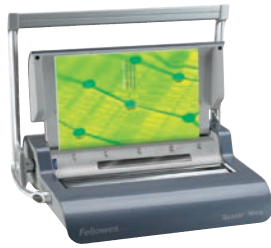

- Carrying handle folds flat
- Punches up to 15 sheets
- Binds 130 sheets with 9/16" wire
- Continuous punch & bind
- Accurate vertical loading
- Adjustable edge guide
- Integrated measuring device

- Built-in comb storage tray
- Waste drawer with window
- 20pk starter kit included
- 2 year limited warranty
- 18" x 15" x 5" / 16 lbs

Galaxy™ W Wire Binding Machine

ITEM NO.
FEL5217801

\$1,131⁹⁹



- Electric one-button touch
- Punches up to 20 sheets
- Binds 130 sheets with 9/16" wire
- Pre-selectable closure control
- Accurate vertical loading
- Adjustable edge guide
- Integrated measuring device

- Full size wire/cover storage
- Chip tray w/burst-out feature
- 20pk starter kit included
- 2 year limited warranty
- 18" x 20" x 7" / 31 lbs

Orion™ E Heavy Duty Electric Comb Binder

ITEM NO.
FEL5643201

\$2,345⁹⁹



- Foot pedal operation
- Punches up to 30 sheets
- Binds up to 500 sheets with 2" comb
- Heavy-duty commercial use
- Adjustable punch depth

- Adjustable edge guide
- 21 releasable dies
- Integrated element selector
- Durable all metal construction
- Extra-large storage tray

- Front access waste tray
- 1 year limited warranty
- 15.8" x 19.8" x 9.8" / 37.5 lbs
- Uses: plastic spines up to 2"

Fellowes Binding Supplies

Item Code	Description	Size	Qty	List
Plastic Binding Spines				
FEL52366	Black, Holds 1-20 pages	1/4"	3000	\$635.70
FEL52507	Black, Holds 21-40 pages	5/16"	3000	\$734.70
FEL52325	Black, Holds 41-55 pages	3/8"	2000	\$545.80
FEL52326	Black, Holds 56-90 pages	1/2"	1200	\$457.08
FEL52327	Black, Holds 91-120 pages	5/8"	500	\$291.45
FEL52367	Black, Holds 121-150 pages	3/4"	500	\$327.95
Wire Binding Spines				
FEL52539	Black, Holds 2-35 pages	1/4"	500	\$279.80
FEL52540	White, Holds 2-35 pages	1/4"	500	\$279.80
FEL5255201	Black, Holds 36-50 pages	5/16"	500	\$315.80
FEL52541	Black, Holds 51-80 pages	3/8"	500	\$345.80
FEL5255401	Black, Holds 81-100 pages	1/2"	500	\$455.80
FEL5255601	Black, Holds 101-130 pages	9/16"	500	\$499.80
Binding Covers				
FEL5224301	Futura Translucent Frost	8.5" x 11"	250	\$399.90
FEL5224501	Futura Translucent Lined	8.5" x 11"	250	\$390.90
FEL5224901	Futura Opaque Black	8.5" x 11"	250	\$291.90
FEL52089	Crystals Transparent Clear	8.5" x 11"	500	\$284.45
FEL52311	Crystals Transparent Clear	8.75" x 11.25"	500	\$286.45
FEL52136	Expressions Textured Grain Navy	8.75" x 11.25"	400	\$134.38
FEL52137	Expressions Textured Grain White	8.75" x 11.25"	400	\$134.38
FEL52138	Expressions Textured Grain Black	8.75" x 11.25"	400	\$134.38
Thermal Binding Covers				
FEL5225301	Clear/Black, Holds 2-15 pages	1/16"	100	\$187.90
FEL5222701	Clear/Black, Holds 16-30 pages	1/8"	100	\$187.90
FEL5222801	Clear/Black, Holds 31-60 pages	1/4"	100	\$187.90
FEL5256101	Clear/Black, Holds 61-90 pages	3/8"	50	\$111.45
FEL5256601	Clear/Black, Holds 120 pages	1/2"	50	\$111.45
FEL5257001	Clear/Black, Holds 240 pages	1"	50	\$121.95

BindMate™ *BindMate™ Personal CombBind® Binding Machine*

ITEM NO.
GBC7706170

- Designed for home office use
- Punches up to 9 sheets
- Binds up to 160 sheets
- 8.5" x 11" max paper size

- Adjusts for oversize covers
- Built-in comb opener
- Uses 19 hole spines up to 3/4"
- Low-force handle

\$109⁴⁹

- 1 yr warranty, 14 days return
- 15.8" x 10.5" x 5.5" / 6.5 lbs
- Uses: CombBind spines



C12 *Personal CombBind® Machine*

ITEM NO.
GBC7706171

\$188⁹⁹

- Ideal for home or small office
- Punches up to 12 sheets
- Binds up to 225 sheets
- Letter, oversize, A4 paper
- 7/8" max comb spine size
- Simple color coded spine guide

- On-board graphic directions
- Low-force full-size handle
- 1 yr warranty, 14 days return
- 15" x 9.8" x 4.5" / 13 lbs
- CombBind spines



C20 *CombBind® Binding Machine*

ITEM NO.
GBC7706172

\$379⁹⁹

- Ideal for med to large offices
- Punches up to 20 sheets
- Binds up to 330 sheets
- Letter, oversize, A4 paper
- 1.5" max comb spine size
- Color alignment indicators
- Color coded spine size guide

- On-board graphic directions
- Low-force full size handle
- Easy empty chip tray
- 1 yr warranty, 14 days return
- 16.5" x 17.8" x 7.3" / 21.5 lbs
- CombBind or ZipBind spines



C110E *CombBind® Electric Binding Machine*

ITEM NO.
GBC7704250

\$626⁹⁹

- One-touch electric operation
- Punches up to 15 sheets
- Binds up to 330 sheets
- 8.5" x 11" max paper size
- Adjusts for oversized covers
- On-board graphic directions

- Color coded spine size guide
- Up to 1.5" max comb size
- Removable chip drawer
- 1 yr warranty, 14 days return
- 19.4" x 17.3" x 11.8" / 19 lbs
- CombBind or ZipBind spines



C210E *CombBind® Electric Binding Machine*

ITEM NO.
GBC7708175

\$836⁹⁹

- One-touch electric operation
- Punches up to 20 sheets
- Binds up to 330 sheets
- 8.5" x 11" max paper size
- Accepts oversized covers
- Guide Right™ alignment

- Color coded spine guide
- Up to 1.5" max comb size
- Removable chip drawer
- 1 yr warranty, 14 days return
- 16" x 14" x 9" / 20 lbs
- CombBind or ZipBind spines



C450E *Precision Punch CombBind® Electric Binding Machine*

ITEM NO.
GBC7709100

\$1,285⁹⁹

- One-touch electric operation
- Punches up to 25 sheets
- Bind 500 sheets with 2" comb
- 8.5" x 11" max paper size
- Accepts oversized covers

- Accurate vertical loading
- Document centering system
- Efficient paper separator
- Comb opening rotary dial
- Removable chip drawer

- 1 yr warranty, 14 days return
- 18" x 13" x 18" / 20 lbs
- CombBind or ZipBind spines



Call Your Sales Representative Today

V110E VeloBind[®] Electric Strip Binding Machine

ITEM NO.
GBC7704260

\$336⁹⁹



- Push button electric punch
- Punches up to 24 sheets
- Binds up to 200 sheets
- Extra large vertical throat
- Accepts oversized paper
- Paper alignment guide
- Convenient jam release lever
- Four pin re-closable strips
- Easily add or remove pages
- Flat for file, stacking, mailing

- 1 yr warranty, 14 days return
- 20.3" x 12.2" x 8.4" / 9 lbs
- Uses: VeloBind spine

P110 Perfect Punch ProClick[®] Binding Machine

ITEM NO.
GBC7708185

\$594⁹⁹



- Moderate use environments
- Punches up to 15 sheets
- Bind 110 sheets with 5/8" comb
- 8.5" x 11" max paper size
- Accepts oversized covers
- Guide Right[™] alignment
- Easily add or remove pages
- Spines snap open and closed
- Low-force full size handle
- Simple slide-out chip tray
- 1 yr warranty, 14 days return
- 16" x 14" x 9" / 16 lbs
- Uses: ProClick 32 hole spines

P210E Perfect Punch ProClick[®] Electric Binding Machine

ITEM NO.
GBC7708180

\$965⁹⁹



- One-touch electric operation
- Punches up to 15 sheets
- Bind 110 sheets with 5/8" comb
- 8.5" x 11" max paper size
- Accepts oversized covers
- Guide Right[™] paper table
- Easily add or remove pages
- Spines snap open and closed
- Simple slide-out chip tray
- 1 yr warranty, 14 days return
- 16" x 14" x 9" / 20 lbs
- Uses: ProClick 32 hole spines

GBC Binding Supplies

Item Code	Description	Fits	Size	Qty	List
GBC4090010	Black CombBind Spines	BindMate, All C series	1/4"	25	\$14.00
GBC4090022	Black CombBind Spines	BindMate, All C series	3/8"	25	\$16.00
GBC4090034	Black CombBind Spines	BindMate, All C series	1/2"	25	\$22.00
GBC4090046	Black CombBind Spines	BindMate, All C series	5/8"	25	\$33.00
GBC15005	Black ZipBind Spines	BindMate, All C series	5/16"	50	\$30.80
GBC15006	Black ZipBind Spines	BindMate, All C series	1/2"	50	\$31.60
GBC2515662	Black ProClick Spines-Small	P110, 210E	5/16"	25	\$33.20
GBC2515660	Black ProClick Spines-Medium	P110, 210E	1/2"	25	\$29.20
GBC9741630	Black VeloBind Flat Spines	V110E	n/a	25	\$36.85
GBC9741631	Blue VeloBind Flat Spines	V110E	n/a	25	\$39.00
GBC9743070	ClearView Prepunched Covers	V110E	8.5" x 11"	25	\$28.30
GBC2001712	Black Leather-Look-Round Corners	All	8.75" x 11.25"	50	\$68.10
GBC2001036	ClearView Covers-Round Corners	All	8.75" x 11.25"	25	\$31.60
GBC2000036	ClearView Covers-Round Corners	All	8.75" x 11.25"	100	\$87.80
GBC2000041	ClearView Covers-Square Corners	All	8.75" x 11.25"	100	\$87.80

Attalus Hot Laminator Supplies

Item Code	Description	Size	Thickness	Qty	List
ATU201000	Business Card	2.25" x 3.75"	5 Mil	100	\$5.99
ATU202000	Business Card	2.25" x 3.75"	7 Mil	100	\$6.99
ATU204000	Data Card	2.3125" x 3.25"	7 Mil	100	\$6.99
ATU207125	Drivers License	2.375" x 3.625"	5 Mil	100	\$4.99
ATU210175	Luggage Tag (prepunched)	2.5" x 4.25"	7 Mil	100	\$6.99
ATU210250	Luggage Tag (prepunched)	2.5" x 4.25"	10 Mil	100	\$9.50
ATU212000	Military Badge	2.625" x 3.875"	7 Mil	100	\$6.99
ATU212250	Military Badge	2.625" x 3.875"	10 Mil	100	\$11.10
ATU213125	Jumbo Card	2.9375" x 4.125"	5 Mil	100	\$5.99
ATU213250	Jumbo Card	2.9375" x 4.125"	10 Mil	100	\$11.50
ATU214000	Letter Size Pouch	9" x 11.5"	3 Mil	100	\$24.00
ATU216000	Letter Size Pouch	9" x 11.5"	5 Mil	100	\$36.50
ATU216175	Letter Size Pouch	9" x 11.5"	7 Mil	100	\$41.60
ATU216250	Letter Size Pouch	9" x 11.5"	10 Mil	50	\$40.75
ATU217000	Legal Size Pouch	9" x 14.5"	3 Mil	100	\$30.15
ATU218500	Legal Size Pouch	9" x 14.5"	5 Mil	100	\$41.90
ATU218175	Legal Size Pouch	9" x 14.5"	7 Mil	100	\$64.30
ATU218250	Legal Size Pouch	9" x 14.5"	10 Mil	50	\$42.00
ATU219075	Menu Size Pouch	12" x 18"	3 Mil	100	\$50.20
ATU219125	Menu Size Pouch	12" x 18"	5 Mil	100	\$71.60
ATU25035	2.25" Core Roll	25" x 500'	1.5 Mil	1	\$52.20
ATU25075	1" Core Roll	25" x 250'	3 Mil	1	\$52.20

ELEMENT SERIES

Standard, Deluxe, Professional



Dry-Lam's new Element Series of laminators is proudly made in America and offers both 27" and 40" width in Standard, Deluxe, and Professional models.

- Safety Shield
- Auto shut off after 2 hours
- Digital LED display
- 1-year parts and 90-days labor warranty
- Built-in Horizontal Trimmer and Cooling Fans in select models.



Dry-Lam Laminating Equipment is a product of Martin Yale Industries.
251 Wedcor Ave. Wabash, IN 46992 | 800.225.5644 | drylam.com | martinyale.com

Call Your Sales Representative Today

LPE3510 Fujipla Desktop Laminator

ITEM NO.
DRLLPE3510

\$1,715⁰⁰



- 13" entry width
- School or office applications
- Ultra fast 3 minute warm-up
- Fixed speed & adjustable temperature controls

- Easy threading
- Laminates 4' per minute
- Uses 1.5 or 3 mil film rolls
- 180 days parts & labor warranty
- 21.7" x 15.4" x 15.6" / 50 lbs

LPE6510 Fujipla Desktop Laminator

ITEM NO.
DRLLPE6510

\$2,460⁰⁰



- 25" entry width
- School or office applications
- Ultra fast 5 minute warm-up
- Fixed speed & adjustable temperature controls

- Easy threading
- Laminates 3' per minute
- Uses 1.5 or 3 mil film rolls
- 180 days parts & labor warranty
- 33.5" x 15.4" x 15.4" / 62 lbs

CL-27SD Element Standard Roll Laminator

ITEM NO.
DRLCL27SD

\$1,845⁰⁰



- 27" wide entry size
- Event tickets, hall passes
- Door signs, bingo cards
- Digital LED display
- 12 minute warm-up time
- Variable temperature control

- Fixed 3 ft /minute speed
- Uses 1.5 to 3 mil film, 1" core
- 3/16" mounting capability
- Safety shield & auto-off
- 180 days parts & labor warranty
- 33.75" x 18.5" x 11.4" / 73 lbs

CL-40SD Element Standard Roll Laminator

ITEM NO.
DRLCL40SD

\$2,710⁰⁰



- Wide 40" throat entry
- Menus, signs and posters
- Class games, certificates
- Digital LED display
- Warms-up in 12 minutes
- Variable temperature control

- Variable 9 ft /minute speed
- Uses 1.5 to 5 mil film, 1" core
- 3/16" mounting capability
- Safety shield & auto-off
- 180 days parts & labor warranty
- 48.5" x 18.5" x 11.4" / 93 lbs

CL-27DX Element Deluxe Roll Laminator

ITEM NO.
DRLCL27DX

\$2,170⁰⁰

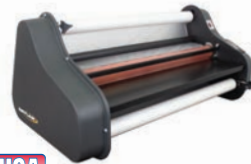

- Wide 27" throat size
- ID badges, event brochures
- Program sheets, book jackets
- Digital LED display
- Warms-up in 12 minutes
- Variable temperature control
- Laminates up to 9 ft /minute

- 1.5 to 5 mil film, 1" core
- 3/16" mounting capability
- Built-in horizontal trimmer
- Safety shield & auto off
- 180 days parts & labor warranty
- 33.75" x 18.5" x 11.4" / 76 lbs

CL-40DX Element Deluxe Roll Laminator

ITEM NO.
DRLCL40DX

\$2,945⁰⁰

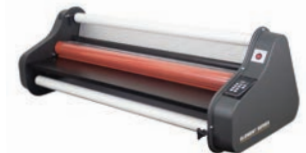

- 40" wide throat size
- Signs, posters, placements
- Dry erase charts, art work
- Digital LED display
- 12 minute warm-up time
- Variable temperature control
- Laminates up to 9 ft /minute

- 1.5 to 5 mil film, 1" or 3" core
- 3/16" mounting capability
- Built-in horizontal trimmer
- Safety shield & auto off
- 180 days parts & labor warranty
- 48.5" x 18.5" x 11.4" / 93 lbs

CL-27PR Element Professional Roll Laminator

ITEM NO.
DRLCL27PR

\$2,810⁰⁰



- Wide 27" throat entry
- Bookmarks, flash cards
- Safety signage, recipes
- Digital LED display
- 12 minute warm-up time
- Variable temperature control
- Laminates up to 9 ft /minute

- Uses 1.5 to 10 mil film, 1" core
- 3/16" mounting capability
- Built-in horizontal trimmer
- Safety shield & cooling fans
- Auto shut off after 2 hours
- 180 days parts & labor warranty
- 33.75" x 18.5" x 11.4" / 81 lbs

CL-40PR Element Professional Roll Laminator

ITEM NO.
DRLCL40PR

\$3,120⁰⁰



- Wide 40" entry size
- Maps, visuals, photographs
- Charts, safety warnings
- Digital LED display
- Warms-up in 12 minutes
- Variable temperature control
- Variable speed of 10 ft /minute

- 1.5 to 10 mil film, 1" or 3" core
- 3/16" mounting capability
- Built-in horizontal trimmer
- Safety shield & cooling fans
- Auto shut-off after 2 hours
- 180 days parts & labor warranty
- 48.5" x 18.5" x 11.4" / 93 lbs

Spectra™ 95 Home Office Laminator
*Must buy in multiples of 4

ITEM NO.
FEL5738201

\$94⁹⁹



- Ideal for home occasional use
- User-friendly, 9.5" entry width
- Beeps when ready in 4 minutes
- Power and ready indicators
- 2 roller hot laminating system
- Laminates 12" per minute
- Disengaging release lever
- Auto shut-off feature
- Uses 3 or 5 mil pouches
- Starter kit included
- 1 year limited warranty
- 14.6" x 7" x 3" / 4 lbs

FEL5739701* (Spectra 125 12.5" throat) **\$120.99**

Cosmic™ 2 95 Personal Laminator
*Must buy in multiples of 2

ITEM NO.
FEL5725601

\$128⁹⁹



- Occasional home or office use
- Slim design, 9.5" entry width
- 5 minute heat up, ready light
- HeatGuard Technology™
- Hot/cold temperature settings
- Laminates 12" per minute
- Easy jam release lever
- Accepts 3-5 mil pouches
- Starter kit included
- 2 year limited warranty
- 17.7" x 5.7" x 4.3" / 5 lbs

Saturn™ 3i 95 Small Office Laminator
*Must buy in multiples of 2

ITEM NO.
FEL5735801

\$236⁹⁹



- Small office or classroom use
- Stylish design, 9.5" entry
- InstaHeat 1 min warm-up time
- Ready beep & indicator light
- Hot/cold temperature settings
- Laminates 12" per minute
- Easy jam release lever
- Auto shut-off feature
- Uses 3 or 5 mil pouches
- Starter kit included
- 2 year limited warranty
- 17" x 5.5" x 4" / 4.3 lbs

FEL5736601* (Saturn3i 125 12.5" throat) **\$308.99**

Callisto™ 95 Small Office Laminator
*Must buy in multiples of 2

ITEM NO.
FEL5728401

\$249⁹⁹



- Moderate small office use
- Professional slim design
- 5 minute heat up, 9.5" entry
- Ready beep & indicator light
- HeatGuard Technology™
- 4 hot/cold temperature settings
- HotSwap technology
- Laminates 15" per minute
- Reverse mode, auto shut-off
- Accepts 3 or 5 mil pouches
- Starter kit included
- 2 year limited warranty
- 17.8" x 5.8" x 4.3" / 5 lbs

FEL5729101* (Callisto 125 12.5" throat) **\$366.99**

Neptune™ 3 125 Desktop Office Laminator

ITEM NO.
FEL5721401

\$440⁹⁹



- Small office high performance
- 12.5" entry width, 1-2 users
- InstaHeat 1 min warm-up time
- Pouch thickness AutoSense
- Unique 4 roller system
- Laminates up to 24" per minute
- Advanced pouch track system
- Re-centering reverse mode
- Auto-off prevents overheating
- Accepts 3 to 7 mil pouches
- Ten pouch starter kit included
- 2 year limited warranty
- 20" x 5.5" x 4.6" / 9.5 lbs

Jupiter™ 2 125 Large Office Laminator

ITEM NO.
FEL5734101

\$536⁹⁹



- For schools or large offices
- 12.5" entry width, 3+ users
- InstaHeat 1 min warm-up time
- Pouch thickness AutoSense
- Superior 6 roller system
- Laminates up to 30" per minute
- Advanced pouch track system
- Self-adjusts to optimal setting
- Re-centering reverse mode
- Auto-off prevents overheating
- Accepts 3 to 10 mil pouches
- Ten pouch starter kit included
- 2 year limited warranty
- 21.5" x 8" x 5" / 15 lbs

Venus™ 2 125 High Performance Laminator

ITEM NO.
FEL5734801

\$675⁹⁹



- InstaHeat 30-60 sec warm-up
- 12.5" entry width, 3+ users
- Pouch thickness AutoSense
- Self-adjusts to optimal setting
- Robust 6 roller system
- Rapid, up to 43" per minute
- Advanced pouch track system
- Feed IQ drives productivity
- Alerts user for next insertion
- Re-centering reverse mode
- Auto-off prevents overheating
- Accepts 3 to 10 mil pouches
- Ten pouch starter kit included
- 2 year limited warranty
- 21.5" x 8.2" x 5" / 15 lbs

Proteus™ 125 Professional Laminator

ITEM NO.
FEL5709501

\$1,722⁹⁹



- Professional high volume use
- 12.5" entry width, multiple users
- Fast 3 minute warm-up time
- Variable temperature settings
- Robust 6 roller system
- Laminates up to 41" per minute
- Re-centering reverse mode
- Auto-off prevents overheating
- Accepts up to 10 mil pouches
- 1 year limited warranty
- 23" x 12" x 6" / 33 lbs

Fellowes Laminator Supplies

Item Code	Description	Size	Thickness	Qty	List
FEL52007	ID Tag-Unpunched	2.625" x 3.875"	5 Mil	500	\$205.80
FEL52033	ID Tag-Punched w/clip	2.625" x 3.875"	5 Mil	500	\$405.80
FEL52031	Business Card	2.25" x 3.75"	5 Mil	1000	\$260.90
FEL5200501	ImageLast UV Protection Letter Size	9" x 11.5"	3 Mil	150	\$142.74
FEL52225	ImageLast UV Protection Letter Size	9" x 11.5"	3 Mil	500	\$395.90
FEL52454	ImageLast UV Protection Letter Size	9" x 11.5"	3 Mil	1000	\$569.90
FEL5743301	Letter Size	9" x 11.5"	3 Mil	1000	\$326.90
FEL5200509	ImageLast UV Protection Letter Size	9" x 11.5"	3 Mil	1500	\$687.90
FEL5244101	ImageLast UV Protection Letter Size	9" x 11.5"	3 Mil	800	\$384.76
FEL5743401	Letter Size	9" x 11.5"	3 Mil	1000	\$304.95
FEL5204002	ImageLast UV Protection Letter Size	9" x 11.5"	5 Mil	500	\$457.90
FEL52040	ImageLast UV Protection Letter Size	9" x 11.5"	5 Mil	1000	\$778.90
FEL5743501	Letter Size	9" x 11.5"	5 Mil	1000	\$465.90
FEL5204007	ImageLast UV Protection Letter Size	9" x 11.5"	5 Mil	900	\$551.94
FEL5245301	ImageLast UV Protection Letter Size	9" x 11.5"	5 Mil	800	\$467.96
FEL5743601	Letter Size	9" x 11.5"	5 Mil	1000	\$444.45
FEL52041	Letter Size	9" x 11.5"	7 Mil	1000	\$1,049.90
FEL52042	Letter Size	9" x 11.5"	10 Mil	500	\$770.90
FEL5221502	Self-Adhesive Letter Sheets	9.25" x 12"	3 Mil	500	\$355.90
FEL52226	Legal Size	9" x 14.5"	3 Mil	500	\$524.90
FEL52011	Menu Size	11.5" x 17.5"	3 Mil	500	\$785.80
FEL5221601	Self-adhesive Laminating Roll	16" x 10' roll	3 Mil	6	\$120.54
FEL5320603	Cleaning Sheets	11.5" x 17.5"		200	\$207.80

Fusion™ 1000L *Personal Laminator*

ITEM NO.
GBC1703072

\$79⁰⁰



- 9" throat width
- Ideal for home craft projects
- Simple, one step laminating
- Warm-up in just 4 minutes
- Fixed temp w/LED ready light
- Compact, easy to store design

- Laminates 13" per minute
- Accepts 3 mil pouches
- Includes 10 EZUse pouches
- 14.6" x 4" x 3" / 3 lbs

Fusion™ 1100L *Personal Laminator*

ITEM NO.
GBC1703074

\$159⁰⁰



- 9" throat width
- Ideal for home or small office
- Fast 3 minute warm-up time
- Audio/visual ready indicators
- Select thickness slider switch
- Release button removes jams

- Auto-off conserves energy
- Laminates 13" per minute
- Uses 3 or 5 mil pouches
- Includes 10 EZUse pouches
- 14 days return policy
- 14.6" x 4" x 3" / 3 lbs

Fusion™ 3000L *Small Office Laminator*

ITEM NO.
GBC1703075

\$280⁰⁰



- 12" throat width
- Fast 40 second warm-up time
- Audio/visual ready indicators
- Hot/cold temperature settings
- Select pouch thickness button
- Alert beeps for jammed pouch

- Reverse button and auto-off
- Laminates 19" per minute
- Uses 3 or 5 mil pouches
- Includes 30 EZUse pouches
- 3 yr warranty, 14 days return
- 19.7" x 5.9" x 4" / 5 lbs

Fusion™ 3100L *Fast Small Office Laminator*

ITEM NO.
GBC1703076

\$395⁰⁰



- 12" throat width
- 1 minute warm-up time
- Audio ready indicators
- Superior quality with 2 rollers
- Jam Alert system, auto-reverse
- Auto-off conserves energy

- Laminates 31" per minute
- Uses 3 to 7 mil pouches
- Includes 30 EZUse pouches
- 3 yr warranty, 14 days return
- 20" x 5.75" x 4.25" / 7.9 lbs

Fusion™ 6000L *High Speed Office Laminator*

ITEM NO.
GBC1703097

\$532⁰⁰



- 12" throat width
- 1 Minute Warm-Up
- Audio/visual ready indicators
- Auto pouch thickness detector
- Superior quality with 4 rollers
- Jam Alert system, auto-reverse
- Auto-off conserves energy

- Laminates 47" per minute
- Uses 3 to 10 mil pouches
- Includes 50 EZUse pouches
- 3 yr warranty, 14 days return
- 22.8" x 9.3" x 4.8" / 10 lbs

Fusion™ 7000L *High Speed Office Laminator*

ITEM NO.
GBC1703098

\$580⁰⁰



- 12" throat width
- 1 Minute Warm-Up
- Audio/visual ready indicators
- Auto pouch thickness detector
- Superior quality with 6 rollers
- Jam Alert system, auto-reverse
- Auto-off conserves energy

- Laminates 55" per minute
- Uses 3 to 10 mil pouches
- Includes 50 EZUse pouches
- 3 yr warranty, 14 days return
- 22.8" x 9.3" x 4.8" / 10 lbs

GBC Laminator Supplies

Item Code	Description	Size	Thickness	Qty	List
GBC3202104	ID Badge	2.5625" x 3.75"	10 Mil	100	\$77.99
GBC3200577	Letter Size Pouch	9" x 11.5"	3 Mil	25	\$27.19
GBC3200587	Letter Size Speed Pouch	9" x 11.5"	5 Mil	100	\$88.89
GBC3740728	Letter Size EZUse Pouch	9" x 11.5"	5 Mil	200	\$128.99
GBC3200578	Legal Size Pouch	9" x 14.5"	3 Mil	25	\$34.59
GBC3740473	Legal Size EZUse Pouch	9" x 14.5"	5 Mil	100	\$154.49
GBC3200579	Menu Size Pouch	12" x 18"	3 Mil	25	\$43.39

Call Your Sales Representative Today

Ultima 35® EZLoad® Roll Laminator

ITEM NO.
GBC1701680

\$1,199⁰⁰



- 12" throat width
- Ideal for schools, small offices
- Quick, under 2 min warm-up
- Ready LED
- Heat Shoe Accutherm tech
- Flawless, consistent results
- Motorized reverse function

- Integrated trimmer, auto-off
- One-touch AutoSpeed
- Laminates up to 36"/minute
- Uses 1.7 to 5 mil film rolls
- 1 year limited warranty
- 16.9" x 18.1" x 11.1" / 35 lbs
- EZ Load blue end cap roll film

Ultima 55® EZLoad® Roll Laminator

ITEM NO.
GBC1710722EZ

\$2,609⁰⁰



- Wide 27" throat width
- Ideal for posters & banners
- Less than 10 min warm-up
- Alignment guide
- Front and back stop buttons
- Slow forward & reverse function
- Integrated trimmer, auto-off
- Footage counter

- Laminates up to 120"/minute
- Uses 1.5 to 3 mil film rolls
- 90 day limited warranty
- 35" x 21" x 14" / 35 lbs
- NAP I, EZ Load roll film
- Light and dark gray end caps

Pinnacle 27® EZLoad® Roll Laminator

ITEM NO.
GBC1701720EZ

\$3,965⁰⁰



- Wide 27" throat size
- Ideal for busy educators
- Warms-up in 8-10 minutes
- Ready LED / 10 speed settings
- Full featured control panel
- Digital temperature readout
- Footage counter tracks use

- Built-in horizontal trimmer
- Reverse function & auto-off
- Variable, up to 12' per minute
- Uses 1.5 to 3 mil film rolls
- 1 year warranty, 14 days return
- 35.8" x 21" x 13.5" / 106 lbs
- NAP I, NAP II, EZ Load gray cap

GBC1701700 (Uses standard film) **\$4,109.00**

Ultima 65® Thermal Roll Laminator

ITEM NO.
GBC1710740

\$3,589⁰⁰



- 27" entry width
- For large, high quality projects
- Warms-up in 10 minutes
- Easy one-touch keypad
- Preset temp & speed controls
- Motorized reverse function
- Laminates 10' per minute

- Safety shield, auto shut-off
- Built-in horizontal trimmer
- Pivoting feed table
- Accepts up to 3 mil film rolls
- 90 day limited warranty
- 32.5" x 21" x 12" / 130 lbs
- Uses: NAP-Lam I film

H700Pro HeatSeal® Professional Pouch Laminator

ITEM NO.
GBC1700500

\$3,755⁰⁰



- Large 18" throat width
- One-touch keypad with LCD
- Fast warm-up, 9 speed settings
- Adjustable temp w/cooling fan

- 4 heated rollers, 2 heat plates
- Reverse function & auto-off
- Laminates up to 60" per minute
- Uses 1.5 to 10 mil pouches

- Accepts .01" mounting boards
- 1 year warranty, 14 days return
- 31.8" x 18" x 11.9" / 45 lbs

GBC Laminator Supplies

Item Code	Fits	Description	Size	Thick	Qty	List
GBC3125365EZ	Ultima 35EZ	Glossy-Nap II	12" x 300'	1.7 mil	2	\$121.99
GBC3125913EZ	Ultima 35EZ	Glossy-Nap II	12" x 200'	3 mil	2	\$161.59
GBC3000052EZ	Ultima 35EZ	Glossy-Nap II	12" x 100'	5 mil	2	\$101.99
GBC3000004EZ	Pinn 27EZ, Ultima 65	Clear-Nap I	25" x 500'	1.5 mil	2	\$112.59
GBC3000024EZ	Pinn 27EZ, Ultima 65	Clear-Nap I	25" x 250'	3 mil	2	\$205.49
GBC3126061EZ	Pinn 27EZ, Ultima 55EZ, Ultima 65	Clear-Nap I	27" x 500'	1.5 mil	2	\$182.69
GBC3125702EZ	Pinn 27EZ	Clear-Nap II	25" x 250'	3 mil	2	\$289.99
GBC3125362EZ	Sprint H925	Clear-Nap II	11.5" x 200'	3 mil	2	\$152.99
GBC3125363EZ	Sprint H925	Clear-Nap II	11.5" x 100'	5 mil	2	\$96.59

HL-923N *Personal Pouch Laminator*

ITEM NO.
RSIHL923N

\$22⁹⁹



- 9" throat width
- Ideal for photos, documents
- Compact design stores easily
- Fast 3 minute warm-up time
- Heat prevents wrinkles, hazing
- Laminates 13.4" per minute

- 2 roller system
- Manual reverse lever
- Uses 3 or 5 mil pouches
- 1 year limited warranty
- 13.6" x 4.5" x 2.8" / 1.87 lbs

HL-1223N *Personal Pouch Laminator*

ITEM NO.
RSIHL1223N

\$39⁹⁹



- 12" throat width
- Ideal for photos, documents
- Compact design stores easily
- Fast 3 minute warm-up time
- Heat prevents wrinkles, hazing
- Laminates 13.4" per minute

- 2 roller system
- Manual reverse lever
- Uses 3 or 5 mil pouches
- 1 year limited warranty
- 16.9" x 4.5" x 2.8" / 2.6 lbs

CL-923 *Personal Laminator*

ITEM NO.
RSICL923

\$37⁹⁹



- 9" throat width
- Preserve, protect & enhance
- Easy fit with slim, sleek design
- Quick 3 minute warm-up time
- Power & ready indicator lights

- Hot and cold lamination
- Jam retrieval release lever
- Uses 3 or 5 mil pouches
- 1 year limited warranty
- 14" x 5.7" x 2.9" / 2.5 lbs

CL-1223 *Personal Laminator*

ITEM NO.
RSICL1223

\$54⁹⁹



- 12" throat width
- Preserve, protect & enhance
- Easy fit with slim, sleek design
- Quick 3 minute warm-up time
- Power & ready indicator lights

- Hot and cold lamination
- Jam retrieval release lever
- Uses 3 or 5 mil pouches
- 1 year limited warranty
- 17" x 6" x 2.6" / 4 lbs

IL-926W *Personal Pouch Laminator*

ITEM NO.
RSIIL926W

\$49⁹⁹



- 9" throat width
- Easy fit with slim, sleek design
- 2 roller design
- Laminates 9.8" per minute
- Quick 1 minute warm-up time

- Auto reverse mode, shut-off
- Uses 3 or 5 mil pouches
- 1 year limited warranty
- 15" x 6" x 3" / 3 lbs

IL-1326W *Personal Pouch Laminator*

ITEM NO.
RSIIL1326W

\$59⁹⁹



- 13" throat width
- Easy fit with slim, sleek design
- 2 roller design
- Laminates 9" per minute
- Quick 1 minute warm-up time

- Auto reverse mode, shut-off
- Uses 3 or 5 mil pouches
- 1 year limited warranty
- 18" x 6" x 3" / 5 lbs

IL-1346W *Professional Pouch Laminator*

ITEM NO.
RSIIL1346W

\$199⁹⁹



- 13" throat width
- Easy fit with slim, sleek design
- 4 roller design
- Touchscreen operation
- Laminates 1.5" per minute

- Quick 1 minute warm-up time
- Auto reverse mode, shut-off
- Uses 3 to 7 mil pouches
- 1 year limited warranty
- 18" x 6" x 3" / 5 lbs

IL-1366W *Professional Pouch Laminator*

ITEM NO.
RSIIL1366W

\$249⁹⁹



- 13" throat width
- Easy fit with slim, sleek design
- 6 roller design
- Touchscreen operation
- Laminates 2" per minute

- Quick 1 minute warm-up time
- Auto reverse mode, shut-off
- Uses 3 to 7 mil pouches
- 1 year limited warranty
- 18" x 6" x 3" / 5 lbs

Call Your Sales Representative Today

RSH-380SL Table Top High Capacity Roll Laminator

ITEM NO.
RSIRSH380SL

\$3,400⁰⁰



- Wide 15" throat size
- Large film roll capacity
- Up to 7.9" roll diameter
- Variable 14.8' per minute
- Silicone rubber hot rollers
- Mounting up to 1/4" thick
- Auto grip core hubs
- 1" or 3" core size
- Easy use digital controls
- 9 speed setting options
- One side de-curling function
- Reverse function & guides
- Built-in cross cutter
- 1 year limited warranty
- 25" x 21.5" x 18" / 91 lbs

Alexis 27 Professional Roll Laminator

ITEM NO.
RSIALEXIS27

\$3,900⁰⁰



- Wide 27" throat entry
- Ideal for schools, print shops
- Posters, banners and signs
- 10 minute warm-up time
- Easy use digital control panel
- 9 step speed control
- Variable 8.2 per minute
- Pivoting table and heat shield
- Built-in rear cross cutter
- Reverse function & guides
- 4 easy clean silicone rollers
- Exit hooks reduce static cling
- Uses 1.5 or 3 mil film rolls
- 1 yr warranty, 6 mo on rollers
- 36" x 20" x 135" / 110 lbs

RSC-820CLS Wide Format Cold Roll Laminator

ITEM NO.
RSIRSC820CLS

\$4,500⁰⁰



- Wide 32" throat size
- Variable 8.2' per minute
- Accepts 1-10 mil film
- Cold pressure sensitive
- Mounting up to 9/32" thick
- Auto grip 3" core size
- 9 speed setting options
- Quick notch gap/grip adjust
- Reverse function & guides
- Built-in rear cross cutter
- Stand, foot control, cover
- 1 year limited warranty
- 43" x 41" x 21" / 154 lbs

RSL-2702S Roll Laminator

ITEM NO.
RSIRSL2702S

\$5,600⁰⁰



- Wide 27" throat size
- Ideal for sign & print shops
- Posters, banners, signs
- Easy use soft touch keypad
- Preset temperature controls
- 10 speed setting options
- Gap adjust up to 6/25"
- Built-in rear cross cutter
- Main roller safety cover
- Reverse function & auto-off
- Variable 7.9' per minute
- 1 year limited warranty
- 31" x 24.5" x 16.5" / 27 lbs

RSC-1401CLTW Wide Format Cold Roll Laminator

ITEM NO.
RSIRSC1401CLTW

\$6,600⁰⁰



- Wide 55" throat size
- Variable 16.4' per minute
- Accepts 1-10 mil film
- Cold pressure sensitive
- Mounting up to 5/8" thick
- Auto grip 3" core size
- 9 speed setting options
- Quick notch gap/grip adjust
- Reverse function & guides
- Built-in rear cross cutter
- Stand and foot control
- 1 year limited warranty
- 67" x 43" x 22" / 188 lbs

RSH-1151 Dual Thermal & Cold Roll Laminator

ITEM NO.
RSIRSH1151

\$15,800⁰⁰



- Wide 45" throat size
- 13' per minute cold
- 9.8' per minute hot
- 20 minute warm-up
- Accepts 1-10 mil film
- Cold pressure sensitive
- Silicone rubber hot rollers
- 2 sided encapsulation
- Mounting up to 5/8" thick
- Auto grip 2.25", 3" core size
- 9 programmable speed sets
- Standby & auto-off modes
- Reverse function & guides
- Built-in rear cross cutter
- Stand, foot control, cover
- 1 year limited warranty
- 59" x 48" x 26" / 363 lbs

RSH-1651 Dual Thermal & Cold Roll Laminator

ITEM NO.
RSIRSH1651

\$17,400⁰⁰



- Wide 65" throat size
- 13' per minute cold
- 9.8' per minute hot
- 40 minute warm-up
- Accepts 1-10 mil film
- Cold pressure sensitive
- Silicone rubber hot rollers
- 2 sided encapsulation
- Mounting up to 5/8" thick
- Auto grip 2.25", 3" core size
- 9 programmable speed sets
- Standby & auto-off modes
- Reverse function & guides
- Built-in rear cross cutter
- Stand, foot control, cover
- 1 year limited warranty
- 77" x 48" x 26" / 553 lbs

208J *Manual Tabletop Folder*

ITEM NO.
MBMFO0601

\$3,389⁰⁰



- 500 sheet capacity
- 14,400 max sheets / hour
- Up to 11" x 17" paper size
- 12 to 80 lb paper weight
- 3 roller friction feed system
- Skew, micro adjustment dials
- 4 digit LED batch/total display
- Auto exit w/extended tray
- Letter, half, double-parallel
- Gate, Z and fold out folds
- 1 year limited warranty
- 41" x 22" x 20" / 67 lbs

408A *Programmable Automatic Tabletop Folder*

ITEM NO.
MBMFO0604

\$4,745⁰⁰



- 500 sheet capacity
- 14,400 max sheets / hour
- Up to 11" x 17" paper size
- 12 to 80 lb paper weight
- Auto sense/displays paper size
- Skew, micro adjustment dials
- 4 digit LED batch/total display
- Auto exit w/extended tray
- Letter, half, double-parallel
- Gate, Z and short-z folds
- Memory stores 18 custom folds
- 1 year limited warranty
- 41" x 21" x 2" / 82 lbs

508A *Programmable Automatic Tabletop Folder*

ITEM NO.
MBMFO0605

\$5,889⁰⁰



- 500 sheet capacity
- 14,400 max sheets / hour
- Up to 11" x 17" paper size
- 12 to 80 lb paper weight
- Auto sense/displays paper size
- Skew, micro adjustment dials
- Color LCD touch display
- Auto exit w/extended tray
- Letter, half, double-parallel
- Gate, Z and short-z folds
- Memory stores 24 custom folds
- 1 year limited warranty
- 40" x 22" x 20" / 68 lbs



P6400 *Desktop Letter/Half Folder*

ITEM NO.
MYIP6400

\$525⁰⁰



- Hand-feed, 1 to 5 sheets
- 2,200 max sheets / hour
- 8.5" x 11" paper size
- 16 to 24 lb paper weight
- Auto-folds inserted paper
- Accepts stapled sets
- Easy to remove unlikely jams
- Letter & half fold types only
- Non-skid feet
- 180 days parts & labor warranty
- 14" x 7" x 7" / 11 lbs

MYIP6200 (Letterfold only) **\$359.00**

P7400 *RapidFold Automatic Desktop Folder*

ITEM NO.
MYIP7400

\$1,005⁰⁰



- 50 sheet capacity
- 4,000 max sheets / hour
- Up to 8.5" x 14" paper size
- 16 to 28 lb paper weight
- Auto feeds & folds 1/2" stack
- Accepts stapled sets manually
- Auto jam detect and shut-off
- Stacking exit tray included
- Letter, half, parallel, Z-folds
- 180 days parts & labor warranty
- 13" x 20" x 11" / 17 lbs

MYIP7200 (Letter or half fold only) **\$785.00**

CR818 *Manual Paper Creaser*

ITEM NO.
MYICR818

\$580⁰⁰

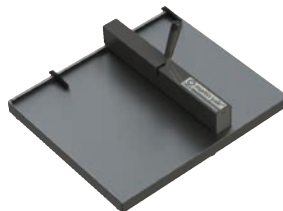

- Smooth, easy lever operation
- Quality literature production
- Set for single or double fold
- Hard aluminum guides/stops
- Accurately creases paper
- Up to 28" wide, 18.2" long
- 341gsm, 130 lb cover, 16 point
- Durable steel construction
- Stable six rubber footed base
- 180 days parts & labor warranty
- 24" x 20" x 5.25" / 26 lbs

CR828 *Semi-Automatic Paper Creaser*

ITEM NO.
MYICR828

\$1,485⁰⁰

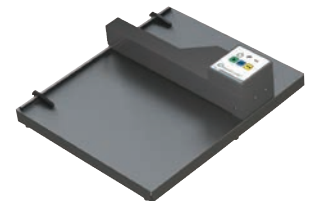

- Designed to perform
- 3 button hand control panel
- Optional foot pedal operation
- Set for single or double fold
- Hard aluminum guides/stops
- Crease up to 28" x 18.2" long
- 341gsm, 130 lb cover, 16 point
- Automatic jam detection
- Durable steel construction
- Six foot table-top security
- 180 days parts & labor warranty
- 24" x 20" x 7" / 33.5 lbs

1611 *Ease-Of-Use AutoFolder*

ITEM NO.
MYI1611

\$2,345⁸⁵



- 150 sheet capacity
- 9,000 max sheets / hour
- Up to 8.5" x 14" paper size
- 16 to 70 lb paper weight
- Self-centering paper guides
- Accepts stapled sets manually

- Auto jam detect and shut-off
- Conveyor belt exit table
- Letter, half, double-parallel
- Church and Z-fold types
- 180 days parts & labor warranty
- 33" x 16" x 13" / 40 lbs

1711 *Electronic Ease-Of-Use AutoFolder*

ITEM NO.
MYI1711

\$3,149⁹⁴



- 150 sheet capacity
- 9,000 max sheets / hour
- Up to 8.5" x 14" paper size
- 16 to 70 lb paper weight
- Self-centering paper guides
- Accepts stapled sets manually

- Auto jam detect and shut-off
- Electronically preset 5 folds
- Letter, half, Z, parallel & gate
- Electronic adjust custom folds
- 180 days parts & labor warranty
- 33" x 16" x 13" / 41 lbs

1217A *Medium-Duty AutoFolder*

ITEM NO.
MYI1217A

\$3,414⁹⁵



- 250 sheet capacity
- 10,300 max sheets / hour
- Up to 12" x 18" paper size
- 16 to 135 lb paper weight
- Fully adjustable paper guide
- Rubber roller paper feeding

- Conveyor belt exit tray
- Letter, half, baronial
- Double-parallel, Z-folds
- Adjustable for custom folds
- 180 days parts & labor warranty
- 42" x 18" x 17" / 59 lbs

1812 *Variable Speed AutoFolder*

ITEM NO.
MYI1812

\$4,956⁶⁴



- 500 sheet capacity
- 5,000 to 12,000 sheets / hour
- Up to 12" x 18" paper size
- 18 to 90 lb paper weight
- Weight range w/no adjusting
- Reverse switch, auto shut-off

- Quiet enclosed fold tables
- Letter, half, double-parallel
- Church, gate, Z, short-z folds
- 180 days parts & labor warranty
- 43" x 22" x 18" / 102 lbs

2051 *Variable Speed SmartFold*

ITEM NO.
MYI2051

\$6,825⁰⁶



- 500 sheet capacity
- 3,000 to 15,000 sheets / hour
- Up to 12" x 18" paper size
- 18 to 90 lb paper weight
- Weight range w/no adjusting
- Keypad with 2 line display
- 7 sensor diagnostics mode

- Quiet enclosed fold tables
- Letter, half, double-parallel
- Church, gate, Z, short-z folds
- Memory stores 10 custom folds
- 180 days parts & labor warranty
- 43" x 22" x 18" / 102 lbs

Mark VII *High Speed AutoFolder*

ITEM NO.
MYIMARKVII

\$7,493⁰⁵

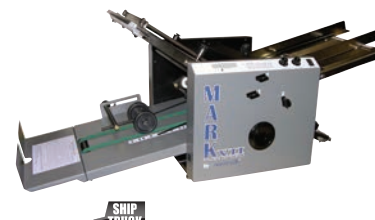

- 350 sheet capacity
- 35,000 max sheets / hour
- Up to 14" x 20" paper size
- 16 to 80 lb paper weight
- Adjustable fold rollers
- Scores and perforates

- Variable speed conveyor
- LED fold counter
- Letter, half, double-parallel
- Church, Z and short-z folds
- 180 days parts & labor warranty
- 43" x 24" x 20" / 108 lbs

Mark VII AF *Airfeed High Speed AutoFolder*

ITEM NO.
MYIMARKVIIAF

\$11,327⁹¹

- For large offices & print shops
- 300 sheet capacity
- Continuous bottom feed
- 35,000 max sheets per hour
- Up to 14" x 20" paper size

- 18 to 80 lb paper weight
- Manual guide & skew adjust
- Adjustable sheet separator
- LED counter, dejam knob
- Perforate & score cartridges

- Variable speed conveyor
- 7 folds: Letter, half, engineer
- Z, church, gate, dbl-parallel
- 180 days parts & labor warranty
- 25" x 22" x 17.8" / 238 lbs



**Stand not included*

MYIMK7700 (Stand).....**\$738.54**

DF-850 *Manual Tabletop Folder*

ITEM NO.
DPODF850

\$2,610⁰⁰



- 500 sheet capacity
- Up to 241 ppm
- Up to 11" x 17" paper size
- 14 to 41 lb paper weight
- 4 digit LCD count display
- Ascend/descending counters
- Easy-to-follow fold charts

- 2 fine-tune adjustment knobs
- Special cross-folding feature
- Single, double, letter, gate
- Half accordion, accordion
- 1 year limited warranty
- 35.4" x 21" x 19" / 71 lbs

DPODF870 (Automatic).....**\$3,760.00**

DF-990 *Automatic Paper Folder*

ITEM NO.
DPODF990

\$4,510⁰⁰



- 1.8" or 500 sheet capacity
- Color LCD touch panel
- Folds 260 sheets per minute
- Up to 12" x 18" paper size
- 52.3 to 157 gsm stock weight
- 3 roller friction feed system
- 5 speeds, power save mode
- Miss-feed and jam detection

- Ascend/descending counters
- Built-in sound absorbers
- Letter, single, double, gate
- Cross, half & full accordion
- 15 custom fold memory
- 1 year limited warranty
- 41" x 20" x 20" / 95 lbs

DPODF990 (30 custom fold memory).....**\$5,170.00**

PAPER HANDLING/LETTER OPENERS



1616 *Desktop Letter Opener*

ITEM NO.
MYI1616

\$195⁰⁰



- Easy one-handed operation
- Auto opens inserted envelope
- Accepts standard business size
- For offices with light mail flow
- Enclosed blade protects fingers

- Non-skid rubber suction feet
- Low noise operation
- 180 days parts & labor warranty
- 9.5" x 7" x 4" / 4 lbs

1628 *Automatic Letter Opener*

ITEM NO.
MYI1628

\$399⁰⁰



- Auto feeds up to 1" high stack
- Accepts standard business size
- Up to 3,000 envelopes/ hour
- For moderate volume offices
- Enclosed blade protects fingers

- Non-skid rubber suction feet
- Low noise operation
- 180 days parts & labor warranty
- 11.5" x 8" x 5" / 5 lbs

1632 *Hands-Free Letter Opener*

ITEM NO.
MYI1632

\$799⁰⁰



- Auto feeds a 1-3/4" high stack
- Accepts standard business size
- Up to 7,000 envelopes/ hour
- For high mail volume needs
- Fully enclosed blade protection

- Non-skid rubber suction feet
- Catch tray folds for storage
- 180 days parts & labor warranty
- 14" x 10.5" x 6" / 12 lbs

62001 *High-Speed Letter Opener*

ITEM NO.
MYI62001

\$3,270⁰⁰



- Auto feeds, opens & collects
- Opens 1-3" stack & 1/4" thick
- Up to 17,500 envelopes/ hour
- Size variety adjustable width
- Large mail volume processing

- Scrap separated when ejected
- Removable receiving tray
- 180 days parts & labor warranty
- 36" x 11" x 12" / 41 lbs

EX5100 *Express Tabber*

ITEM NO.
MYIEX5100

\$5,100⁰⁰

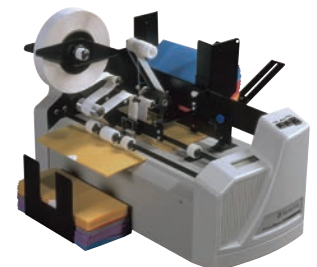

- Seals mail with adhesive tab
- No envelope lowers mail costs
- Precision tab location control
- Handles media 5" to 12" wide

- Processes up to 7,500 pieces/hr
- USPS standard compliant
- Batch counter, quiet operation
- Clear tabs not recommended

- 180 days parts & labor warranty
- 20" x 21" x 17" / 40 lbs

Call Your Sales Representative Today

3030 Automatic Letter Opener

ITEM NO.
PMK3030

\$4,285⁰⁰



- Easy operation manual feed
- Auto-opens inserted envelope
- Rotary cuts wide and deep
- Up to 14" maximum width
- Accepts 1/4" thick envelopes

- Slices thru Tyvek and plastic
- Removable chaff bin
- 1 year limited warranty
- 18" x 9" x 6" / 27 lbs

3056 Automatic Letter Opener

ITEM NO.
PMK3056

\$5,145⁰⁰

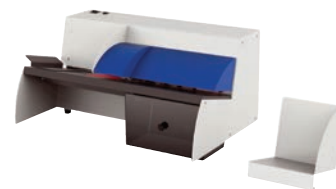

- Auto feeds, opens & collects
- Two long life quality motors
- Simple and reliable processing
- Up to 8,000+ envelopes/ hour
- Mixed thickness separator
- Accepts up to 1/4" thick

- Milling cutter technology
- Removes 1/8" envelope edge
- Creates soft, feathered opening
- Removable waste bin
- 1 year limited warranty
- 28" x 18" x 13.5" / 79 lbs

3066 Automatic Letter Opener w/Stand

ITEM NO.
PMK3066

\$6,715⁰⁰



- Large mail volume processing
- Two high performance motors
- 100 envelope feed/exit capacity
- Up to 12,000+ envelopes/ hour
- Mixed thickness separator
- Accepts up to 1/4" thick

- Removes 1/8" envelope edge
- Creates soft, feathered opening
- Stand and waste bin included
- 1 year limited warranty
- 42" x 30" x 42" / 220 lbs

3068 Automatic Letter Opener w/Stand

ITEM NO.
PMK3068

\$8,570⁰⁰



- Solid operational reliability
- Large mail volume processing
- Up to 10,000+ envelopes/ hour
- Mixed thickness separator
- Up to 1/4" thick media
- Feathered edge prevents cuts
- Batch, rate, lifetime counters

- Milling cutter, variable speed
- Solid all metal construction
- Stand and waste bin included
- 1 year limited warranty
- 42" x 30" x 42" / 200 lbs

PMKPRINTSYS \$3,332.00

3078 High Speed Automatic Letter Opener w/Stand

ITEM NO.
PMK3078

\$10,170⁰⁰



- Built to increase production
- Reverse flow conveyor
- Two high performance motors
- Up to 20,000+ envelopes/ hour
- On demand or delay feeding

- All sizes/types up to 1/4" thick
- Mixed thickness separator
- Batch, rate, lifetime counters
- Milling cutter, variable speed
- High quality steel components

- Stand and waste bin included
- 1 year limited warranty
- 42" x 30" x 47" / 260 lbs

PMKPRINTSYS \$3,332.00



Martin Yale
Quality Delivered, Service Guaranteed.

DP20 Master Duo Punch

ITEM NO.
MYIDP20

\$72⁰⁰



- No adjustments required!
- One side is dedicated 3 hole
- Other side dedicated 2 hole
- Punches up to 20 sheets
- 9/32" pin diameter

- Lever slices thru 20 lb bond
- Lock down handle for storage
- High-capacity chip pan
- 180 days parts & labor warranty
- 10.8" x 5.4" x 4.8" / 2.8 lbs

EP210 Master Electric Paper Punch

ITEM NO.
MYIEP210

\$121⁵⁰



- Electric or 4-AA battery option
- Punches up to 12 sheets
- 1/4" diameter, 2 hole pattern
- Easy use, desktop design
- Reverse dejam mechanism

- Adjustable alignment guide
- Large-capacity chip pan
- 180 days parts & labor warranty
- 5.8" x 4.8" x 3.5" / 1.2 lbs

A135 SmartTouch™ Desktop Punch

ITEM NO.
SWIA7074135

\$26⁹⁹



- Reduced effort, 50% less
- Soft grip comfort handle
- Punches up to 20 sheets
- 2 hole pattern, 9/32" heads
- Built-in ruler & edge guide
- Extendable 11" paper guide

- Removable base chip disposal
- Compact storage handle lock
- Durable metal construction
- 1 yr warranty, 14 days return
- 2.3" x 5.8" x 4.3" / 1 lb

A134 SmartTouch™ Desktop Punch

ITEM NO.
SWIA7074134

\$30⁹⁹



- Comfortable soft touch lever
- Low force, 40% reduced effort
- Punches up to 12 sheets
- 3 hole pattern, 9/32" heads
- Built-in ruler & edge guide
- See chips thru base pattern

- Flip-open chip tray feature
- Compact storage handle lock
- Durable metal construction
- 1 yr warranty, 14 days return
- 1.8" x 12" x 3.3" / 1.4 lbs

SWIA7074133 (3-hole / 20 sheets) \$41.99

A030 LightTouch® Desktop Punch

ITEM NO.
SWIA7074030

\$63⁹⁹



- Wide grip soft touch lever
- Reduced force, 50% less effort
- Punches up to 20 letter sheets
- Semi-adjustable up to 7-heads (3 punch heads included)
- Extra heads sold separately

- Easy spill resistant chip tray
- Lock down handle for storage
- 100% performance guarantee
- Lifetime limited warranty
- Strict 14 days return policy
- 2.8" x 12" x 6.8" / 3 lbs

A136 SmartTouch™ Desktop Punch

ITEM NO.
SWIA7074136

\$80⁹⁹



- Reduced effort, 50% less
- Oversized cushioned handle
- Punches up to 45 sheets
- 3 hole pattern, 9/32" heads
- Edge guide for alignment
- Perforated base for tray view

- Easy pull-out chip tray
- Push button locking handle
- Durable metal construction
- 1 yr warranty, 14 days return
- 2.8" x 12" x 7.4" / 3.6 lbs

A350 Adjustable Heavy Duty Punch

ITEM NO.
SWIA7074350

\$102⁹⁹



- Useful manual lever handle
- 32 sheet punch capacity
- Versatile, up to 7 hole pattern
- Extra heads sold separately
- Sharp cut 9/32" punch heads

- High performance punching
- Margin depth & paper guide
- Durable metal construction
- 90 day warranty, 14 days return
- 5.5" x 10.3" x 7" / 3.6 lbs

A357 LightTouch™ Heavy Duty Punch

ITEM NO.
SWIA7074357

\$159⁹⁹



- Unique top loading design
- Requires 50% less punch effort
- Up to 40 sheets hassle-free
- Fully adjustable centers
- Flexible 2 to 7 hole pattern
- Fused punch heads & handle

- Delivers jam free control
- Translucent chip drawer
- 100% performance guarantee
- Lifetime limited warranty
- Strict 14 days return policy
- 15.7" x 9" x 6" / 8 lbs

A450 Adjustable Heavy Duty Punch

ITEM NO.
SWIA7074450

\$194⁹⁹



- T-handle design adds leverage
- Punches up to 40 sheets
- Adjustable up to 7-hole punch (4 punch heads included)
- Extra heads sold separately
- Patented pin technology
- Face plate inch/metric marks

- Durable metal construction
- Large removable chip tray
- Lifetime limited warranty
- Strict 14 days return policy
- 14.3" x 7.9" x 4.5" / 6.6 lbs

A650 Adjustable Heavy Duty Punch

ITEM NO.
SWIA7074650

\$459⁹⁹



- Ergonomic designed handle
- Powerful 160 sheet capacity
- 2 or 3 hole punch pattern
- Engineered for 30% less force
- One-touch adjustment disk
- Paper guide & finger guard

- Antimicrobial protection
- Easy removable chip tray
- 100% performance guarantee
- 6 mth warranty, 14 days return
- 15.3" x 14.5" x 8" / 16 lbs

A515 *Electric Portable Punch*

ITEM NO.
SWIA7074515

\$119⁹⁹



- Seamless automatic operation
- Sleek design, ideal for travel
- Punches up to 15 letter sheets
- Standard 3 hole punch pattern
- Punches 9/32" diameter holes
- Reset button easily clears jams

- No mess hinged chip drawer
- Electric or 6-AA battery option
- 1 yr warranty, 14 days return
- 1 year limited warranty
- 13" x 7" x 4" / 1.5 lbs

3230 *Electric Paper Punch*

ITEM NO.
SWI7704270

\$239⁹⁹



- Simple push-button operation
- Punches up to 24 sheets
- Adjustable 2 or 3 hole pattern
- Wide throat for oversized paper
- Perfect punch alignment guide

- Clear jams with reverse knob
- Viewing window on chip tray
- 1 yr warranty, 14 days return
- 13" x 7" x 5" / 11 lbs

SWI7704280 (3230ST w/Stapler).....\$448.99

A535 *Commercial Electric Paper Punch*

ITEM NO.
SWIA7074535

\$399⁹⁹



- Effortless push button design
- Smooth function, less noise
- Excellent for quiet offices or shared workspaces
- Up to 28 sheets at once

- 3 hole pattern, 9/32" heads
- Large removable chip drawer
- 100% performance guarantee
- 2 yr warranty, 14 days return
- 15" x 6" x 10" / 10 lbs

350MD *Medium Duty Paper Punch*

ITEM NO.
SWI9800350

\$612⁹⁹



- Intuitive electric paper punch
- Simple push-button operation
- 50 sheet punch capacity
- Standard 3 hole punch pattern
- Easy page turning 9/32" holes

- Reverse switch clears jams
- Clear view window chip tray
- 2 yr warranty, 14 days return
- 14" x 12" x 5" / 14 lbs

A190 *Extra Heavy Duty Desktop Punch*

ITEM NO.
SWIA7074190

\$196⁹⁹



- Wide handle, compact design
- Meets frequent usage needs
- Up to 100 sheets with ease
- Standard 2 hole punch pattern
- Punches 9/32" diameter holes
- Adjustable alignment guide

- Durable metal construction
- Long lasting performance
- Removable base chip disposal
- Closed position handle lock
- 6 mth warranty, 14 days return
- 5" x 10.6" x 4.8" / 5 lbs

A192 *Extra High Capacity Desktop Punch*

ITEM NO.
SWIA7074192

\$517⁹⁹



- Ideal for shared environments
- Made for high capacity projects
- Punches up to 300 sheets
- Two step process is easy
- Fixed 2 hole punch pattern
- Clean 9/32" diameter holes

- Operating instructions on base
- Cushioned handle locks down
- Durable metal construction
- Fully removable chip tray
- 6 mth warranty, 14 days return
- 7" x 17" x 7.8" / 10 lbs

A194 *Extra High Capacity Desktop Punch*

ITEM NO.
SWIA7074194

\$585⁹⁹



- Maximize punching productivity
- Pierces through 300 sheets
- 2 steps, 150 sheets at a time
- Creates 3 evenly spaced holes

- Clean 9/32" diameter holes
- Operating instructions on base
- Cushioned handle locks down
- Durable metal construction

- Fully removable chip tray
- 6 mth warranty, 14 days return
- 12.4" x 17" x 7.8" / 16 lbs

507 Personal Rolling Trimmer

ITEM NO.
DAH507

\$75⁰⁰

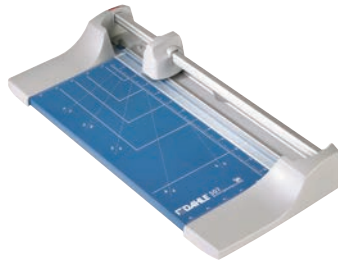

- 12-1/2" cutting length
- 7 sheet capacity
- German engineered for precision
- Ground self-sharpening blade
- Automatic clamp holds work
- Metal base, non-slip rubber feet

- Lightweight & portable
- Preprinted guides for sizing
- Designed for safety & accuracy
- Lifetime limited warranty
- 17.25" x 8.25" x 2.25" / 3 lbs

DAH508 (18" Cutting length) **\$85.00**

556 Professional Rolling Trimmer

ITEM NO.
DAH556

\$650⁰⁰

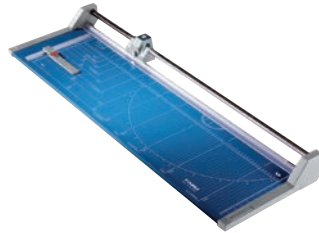

- 37-3/4" cutting length
- 14 sheet capacity
- German engineered for precision
- Ground self-sharpening blade
- Automatic clamp holds work
- Blade cuts in both directions

- Screened guides for easy sizing
- Metal base, non-slip rubber feet
- Optional floor stand available
- Lifetime limited warranty
- 45.5" x 14.13" x 3.25" / 19 lbs

442 Premium Rolling Trimmer

ITEM NO.
DAH442

\$520⁰⁰



- 20" cutting length
- 30 sheet capacity
- Precision German engineered
- Self-sharpening cutting blade
- Automatic clamp holds secure
- Cuts paper, canvas, mat board

- Metal base w/non-slip feet
- Preprinted paper sizing guide
- Designed for safety & accuracy
- Lifetime limited warranty
- 28" x 15.13" x 4" / 14 lbs

DAH440 (14-1/8" cutting length) **\$390.00**

DAH444 (26-3/8" cutting length) **\$650.00**

448 Premium Large Format Rolling Trimmer

ITEM NO.
DAH448

\$990⁰⁰



- 51-1/8" cutting length
- 20 sheet capacity
- Precision German engineered
- Self-sharpening cutting blade
- Automatic clamp holds secure
- Blade cuts in both directions

- Metal base w/non-slip feet
- Preprinted paper sizing guide
- Optional floor stand available
- Lifetime limited warranty
- 59" x 15.13" x 4" / 21 lbs

DAH448S (w/Stand) **\$1,650.00**

550 Professional Rolling Trimmer

ITEM NO.
DAH550

\$300⁰⁰

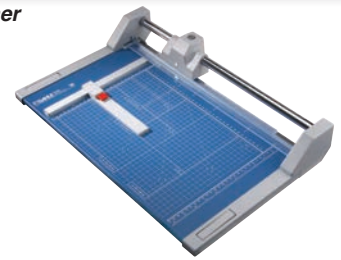

- 14-1/8" cutting length
- 20 sheet capacity
- Ground self-sharpening blade
- German engineered for precision
- Automatic clamp holds work
- Blade cuts in both directions

- Screened guides for easy sizing
- Metal base, non-slip rubber feet
- Lifetime limited warranty
- 21.88" x 14.13" x 3.3" / 11 lbs

DAH552 (20" cutting length) **\$350.00**

DAH554 (28-1/4" cutting length) **\$470.00**

558 Professional Rolling Trimmer

ITEM NO.
DAH558

\$760⁰⁰



- 51-1/8" cutting length
- 12 sheet capacity
- German engineered for precision
- Ground self-sharpening blade
- Automatic clamp holds work
- Blade cuts in both directions

- Screened guides for easy sizing
- Metal base, non-slip rubber feet
- Lifetime limited warranty
- 14" x 59" x 40.5" / 27 lbs

446 Premium Large Format Rolling Trimmer

ITEM NO.
DAH446

\$850⁰⁰



- 36-1/8" cutting length
- 22 sheet capacity
- Precision German engineered
- Self-sharpening cutting blade
- Automatic clamp holds secure
- Blade cuts in both directions

- Metal base w/non-slip feet
- Preprinted paper sizing guide
- Optional floor stand available
- Lifetime limited warranty
- 44.13" x 15.13" x 4" / 14 lbs

DAH446S (w/Stand) **\$1,420.00**

472 Premium Large Format Rolling Trimmer

ITEM NO.
DAH472

\$1,950⁰⁰



- 72" cutting length
- 12 sheet capacity
- Cuts paper, canvas, mat board
- German engineered for precision
- Ground self-sharpening blade
- Automatic clamp holds work

- Blade cuts in both directions
- Screened guides for easy sizing
- Metal base, non-slip rubber feet
- Optional floor stand available
- Lifetime limited warranty
- 79.5" x 15.13" x 4" / 48 lbs

DAH472S (w/Stand) **\$2,990.00**

Call Your Sales Representative Today

12E Vantage® Guillotine Trimmer

ITEM NO.
DAH12E

\$89⁹⁵



- 12" cutting length
- 15 sheet capacity
- Machine ground blade
- Auto clamp holds work firmly
- Metal base won't warp or crack
- Blade won't fall unexpectedly
- Blade lockable in down position

- Screened guides for easy sizing
- Comfortable ergonomic handle
- Lightweight & portable design
- 1 year limited warranty
- 19.75" x 10.25" x 2.5" / 7 lbs

DAH15E (15" Cutting length) **\$99.95**
DAH18E (18" Cutting length) **\$129.95**

565 Professional Guillotine Trimmer

ITEM NO.
DAH565

\$790⁰⁰



- 15-1/8" cutting length
- 35 sheet capacity
- German engineered for precision
- Ground self-sharpening blade
- Rotating safety shield
- Blade won't fly up or fall down

- Automatic clamp holds work
- Preprinted guides for easy sizing
- Metal base, non-slip rubber feet
- Lifetime limited warranty
- 18.75" x 14" x 8" / 23 lbs

DAH561 (14-1/8" cutting length)..... **\$520.00**
DAH567 (21-5/8" cutting length)..... **\$1,550.00**

580 Premium Large Format Guillotine Cutter

ITEM NO.
DAH580

\$3,300⁰⁰



- 32" cutting length
- 30 sheet capacity
- German engineered for precision
- Ground self-sharpening blade
- Acrylic shield protects hands
- Manual foot clamp secures work

- Adjustable guide for repeat cuts
- Screened grid on metal base
- Sturdy stand for optimal height
- Limited lifetime warranty
- 34" x 38" x 49" / 133 lbs

DAH585 (43-1/4" cutting length) **\$4,400.00**

846 Professional Series Stack Cutter

ITEM NO.
DAH846

\$3,300⁰⁰



- 16-7/8" cut length
- Up to 500 sheet capacity
- German engineered for precision
- Ground Solingen steel blade
- Built in dual safety shields
- Quick action manual clamp

- Easily cut through reams of paper
- Spindle driven locking backstop
- Ergonomically correct handle
- Shown on optional floor stand
- Limited lifetime warranty
- 30" x 25.5" x 19.5" / 110 lbs

DAH842 (200 sheets/16-7/8" cutting length) **\$2,200.00**
DAH848 (700 sheets/18-5/8" cutting length) **\$4,400.00**

40008 Vantage® Scissors 6pk
**Must buy in packs of 6*

ITEM NO.
DAH40008

\$66⁹⁵



- 8" scissor length
- Machine ground blades
- Blades maintain sharp edges
- Contoured comfort grip

- Rust resistant stainless steel
- Quality scissor at a low price
- Ideal for home, office, crafts
- 90 day warranty

***DAH40005** (6pk 5" scissors) **\$38.25**
***DAH40006** (6pk 6" scissors) **\$43.05**

40028 Vantage® Comfort-Grip Scissors
**Must buy in packs of 6*

ITEM NO.
DAH40028

\$95⁶⁵



- 8" scissor length
- Soft contoured handle
- Rubberized surface grip
- Machine ground blades

- Blades maintain sharp edges
- Rust resistant stainless steel
- Ideal for home, office, crafts
- 90 day warranty

***DAH40025** (6pk 5" scissors) **\$66.95**
***DAH40026** (6pk 6" scissors) **\$86.10**

10680 Vantage® Self Healing Cutting Mat-Crystal Clear
**Must buy in packs of 12*

ITEM NO.
DAH10680

\$153⁰⁰



- 3mm thick PVC construction
- 5 layers protects work surface
- Ideal for cutting, sewing & crafts
- Double sided for versatility

- Protects blade from dulling
- 1/2" grid lines for proper sizing
- Screened inch, metric & angles

***DAH10681** (12pk 12" x 18" Crystal Clear)..... **\$260.20**
***DAH10682** (12pk 18" x 24" Crystal Clear)..... **\$413.30**
***DAH10683** (12pk 24" x 36" Crystal Clear)..... **\$688.80**
***DAH10684** (6pk 36" x 48" Crystal Clear)..... **\$734.70**

10690 Vantage® Self Healing Cutting Mat-Bright Blue
**Must buy in packs of 6*

ITEM NO.
DAH10690

\$112⁴⁵

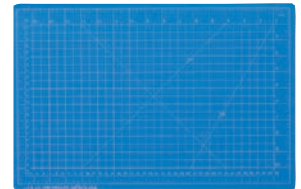

- 3mm thick PVC construction
- 5 layers protects work surface
- Ideal for cutting, sewing & crafts
- Double sided for versatility

- Protects blade from dulling
- 1/2" grid lines for proper sizing
- Screened inch, metric & angles

***DAH10691** (12pk 12" x 18" Bright Blue)..... **\$122.45**
***DAH10692** (12pk 18" x 24" Bright Blue)..... **\$183.70**
***DAH10693** (12pk 24" x 36" Bright Blue)..... **\$551.00**
***DAH10694** (6pk 36" x 38" Bright Blue)..... **\$596.95**

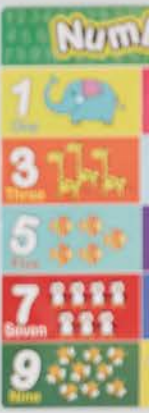

— THE — EFFORTLESS LAMINATOR



GBC ULTIMA[®] 55 LAMINATOR

Produce posters, signs, flash cards and more effortlessly with the 27" Ultima 55 Desktop Roll Laminator. Spend less time laminating and more time in the classroom thanks to GBC's patented EZload film system to eliminate film loading errors.



V-417 Cut Sheet Burster

ITEM NO.
DPOV417

\$5,500⁰⁰



- Ideal finishing solution
- Separates perforated forms
- Stacks in sequential order
- Up to 11" x 17" paper size
- Top feed up to 400 sheets
- 5-level speed adjustment
- Up to 140 sheets per minute

- LCD preset counter display
- Adjustable width side guides
- Last job memory
- 1 year limited warranty
- 28" x 19" x 9" / 60 lbs

V-590 Sheet Cutter

ITEM NO.
DPOV590

\$6,120⁰⁰



- Cuts, slits or perforates forms
- Precise, razor sharp edges
- 500 sheet feed tray capacity
- Up to 14" x 17" paper size
- Guillotine cutter method
- Up to 44 sheets per minute
- Interactive control panel

- 6 pre-programmed cut sizes
- Adjustable width side guides
- 100 custom memory selections
- Interlock safety cover system
- 1 year limited warranty
- 32" x 23" x 10" / 71 lbs

CC-229 DocuCutter Card Cutter

ITEM NO.
DPOCC229

\$6,750⁰⁰



- Full-bleed business card apps
- Photo, post or greeting cards
- Up to 130 business cards / min
- Continuous feed up to 75 sheets
- Accepts letter/legal size paper
- Converts into 2" x 3.5" (letter); 3.5" x 5" cards (legal)

- Slit/Score/Perf cassettes
- 13 pre-programmed jobs
- 7 custom jobs; LCD display
- Accurate cut mark sensor
- 1 yr mechanical warranty
- 18" x 18" x 15" / 85 lbs

CC-330 DocuCutter Card Cutter

ITEM NO.
DPOCC330

\$9,800⁰⁰



- Ideal for digital print shops
- Up to 240 business cards / min
- 3 roll/2 wheel consistent feed
- Up to 2" or 120 sheet capacity
- Up to 13" x 19" paper size
- Converts into 2" x 3.5" (24-up); 3.5" x 5" or 8" cards (12" x 18")

- Easily interchange cassettes
- 7 pre-programmed jobs
- 6 custom jobs; LCD display
- Accurate cut mark sensor
- 1 yr mechanical warranty
- 22" x 20" x 40" / 135 lbs

Fellowes

PAPER HANDLING/CUTTERS

Electron™ 180 Rotary Trimmer

*Must buy in multiples of 4

ITEM NO.
FEL5410502

\$120⁹⁹



- 18" cutting length
- 10 sheet capacity
- Metal base w/paper clamp
- Enclosed SafeCut™ blade
- LED guide indicates cut line

- 4 interchangeable blade styles
- Integrated cartridge storage
- 2 year limited warranty
- 9" x 25" x 3" / 4 lbs

Plasma™ 150 Paper Cutter

ITEM NO.
FEL5411002

\$407⁹⁹

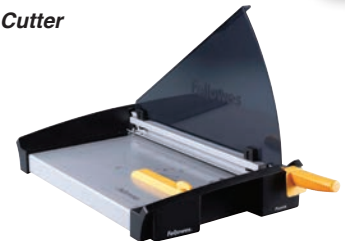

- 15" cutting length
- 40 sheet capacity
- Solid metal base & steel blade
- Automatic locking paper clamp
- Foldable SafeCut™ Guard

- Various size cutting guides
- Adjustable back edge guide
- Carry handle & non-skid feet
- 2 yr warranty, 10 on blades
- 15" x 27" x 5" / 15 lbs

FEL541102 (18" cutting length).....**\$468.99**



PAPER HANDLING/CUTTERS

RET-1652 Wide Format Electric Trimmer

ITEM NO.
RSIRET1652

\$3,980⁰⁰



- Wide 65" throat size
- 6.6'/second blade speed
- Bidirectional rotary blade
- Full length activation bar
- Open-back for long prints

- Cutting edge LED lighting
- Hands-free w/foot pedal
- Built-in safety covers
- Waste catcher for trim scraps
- Stand w/casters for mobility

- 1 year limited warranty
- 78" x 40" x 20" / 106 lbs

P212X Premier PolyBoard™ Paper Trimmer

ITEM NO.
MYIP212X

\$1077⁰



- 12" cutting length
- 10 sheet capacity
- Unbreakable molded base
- Guaranteed not to crack/warp
- Torsion spring, auto blade lock

- Permanent grid & dual rulers
- Soft-grip handle, non-skid feet
- 180 days parts & labor warranty
- 13" x 20" x 2" / 5 lbs

MYIP215X (15" cutting length) **\$117.38**
MYIP218X (18" cutting length) **\$231.13**

T12 SharpCut™ Paper Trimmer

ITEM NO.
MYIT12

\$122²²

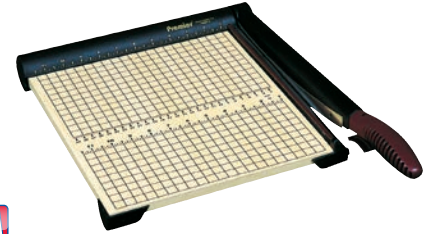

- 12" cutting length
- 15 sheet capacity
- Medium-duty 1/2" wood base
- Clamp securely hold stacks
- Torsion spring & finger guard

- Patented auto blade latch lock
- Permanent grid & dual rulers
- Non-skid rubber feet
- 180 days parts & labor warranty
- 13" x 20" x 2" / 5 lbs

MYIT15 (15" cutting length) **174.26**

W12 Heavy Duty Wood Paper Trimmer

ITEM NO.
MYIW12

\$215⁴⁰



- 12" cutting length
- 20 sheet capacity
- For school, church, business
- Flyers, covers, scrapbooking
- Paper, mat board, film, textiles
- Ergonomic soft-grip handle

- Solid 3/4" thick wood base
- Through-hardened steel blade
- Self-sharpening stainless steel
- Fall prevention Torsion spring
- Full blade length finger guard
- Patented auto blade latch lock

- Permanent grid & dual rulers
- Non-skid rubber feet
- 180 days parts & labor warranty

Martin Yale Trimmers

Item Code	Description	List
MYIW15	15" cutting length	\$306.16
MYIW18	18" cutting length	\$367.88
MYIW24	24" cutting length	\$504.62
MYIW30	30" cutting length	\$797.47
MYIWC36	36" cutting length w/clamp	\$1,148.40



NXT PREMIUM
REPLACEMENT CARTRIDGE

The NeXT Best Thing in Toner!

Call Your Sales Representative Today

715 *StakCut™ Heavy Duty Wood Paper Trimmer*

ITEM NO.
MYI715

- 15" cutting length
- 30 sheet capacity
- Solid 3/4" thick wood base
- Clamp securely holds stacks

- Torsion spring & finger guard
- Patented auto blade latch lock
- Permanent grid & dual rulers
- Soft-grip handle, non-skid feet

\$459⁸⁴

- 180 days parts & labor warranty
- 10.5" x 15" x 6" / 16 lbs

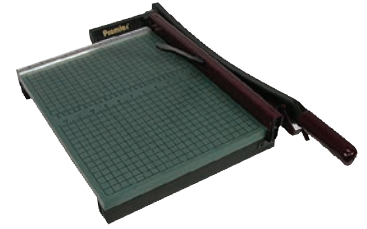

MYI724 (24" Cutting length) **\$703.08**

7000E *Commercial Stack Cutter*

ITEM NO.
MYI7000E

\$1,645⁷⁶



- 12" cutting length
- 350 sheet capacity
- Heavy duty wood base
- Ideal for photo or print shops
- Positive clamp holds paper

- Manual release blade latch
- Adjustable back gauge
- Precise dual ruler guides
- 180 days parts & labor warranty
- 20" x 30" x 16" / 45 lbs

620RC *Manual Stack Cutter*

ITEM NO.
MYI620RC

\$5,503⁴⁴



- 18.5" cutting length
- 3.14" cut height capacity
- Up to 800 sheet capacity
- Heavy duty metal base
- Precise manual back gauge
- Quick action manual clamp

- Even pressure across surface
- Cutting line light
- Optimal height sturdy stand
- 180 days parts & labor warranty
- 30" x 31.5" x 30" / 250 lbs

BCS212 *Business Card Slitter*

ITEM NO.
MYIBCS212

\$3,022⁸⁷



- Up to 375 cards / minute
- Continuous feed up to 5/8"
- 2 pass operation (12up format)
- Accepts 8.5" x 11" size sheets
- Converts into 2" x 3.5" cards

- Semi-self sharpening blades
- Adjustable paper guides
- Steel construction, catch tray
- 180 days parts & labor warranty
- 15" x 6" x 11" / 35 lbs

SP200 *Business Card Slitter*

ITEM NO.
MYISP200

\$2,563⁰³



- Score & perforating capability
- Ticket, occasion, tent styles
- Fully adjustable paper guides
- Accepts 3.5" x 12" wide sheets
- Up to 1,400 sheets / hour

- Holds 5/8" stack 24-100 lb stock
- Adjustable hubs for easy setup
- (4) 14 tooth wheels included
- Additional wheels available
- 180 days parts & labor warranty
- 18" x 15.5" x 10.8" / 35 lbs

BCS412 *Business Card Slitter and Scorer*

ITEM NO.
MYIBCS412

\$4,011⁵⁴



- Up to 375 cards / minute
- Continuous feed up to 5/8"
- 2 pass operation (12up format)
- Accepts 8.5" x 11" size sheets

- Converts into 2" x 3.5" cards
- Cuts, perforates & scores
- Semi-self sharpening blades
- Adjustable paper guides

- Steel construction, catch tray
- 180 days parts & labor warranty
- 15" x 10.4" x 13" / 44 lbs



1134 Small Format Rotary Trimmer

ITEM NO.

MBM1134

\$349⁰⁰



- 13.75" cutting length
- 25 sheet capacity
- Solingen steel blade set
- Manual clamp, rubber feet
- 12" x 15" all metal table
- Transparent safety guard

- Integrated cut line indicator
- Precision side scale guides
- Standard paper sizes on table
- Adjustable back gauge
- 1 year limited warranty
- 13.3" x 22" x 12" / 11 lbs

MBM1135 (Auto clamp).....**\$429.00**
MBM1046 (18" cutting length).....**\$649.00**

1038 Triumph Guillotine Trimmer

ITEM NO.

MBM1038

\$729⁰⁰



- 14.75" cutting length
- 50 sheet capacity
- Solingen steel blade set
- Solid independent hand clamp
- 16" x 14.25" all metal table
- Transparent Lexan® safety guard
- Fold-away paper supports

- Precision side scale guides
- Standard paper sizes on table
- Adjustable front gauge
- 1 year limited warranty
- 23" x 15.5" x 10" / 29 lbs

MBM1058 (22.5" cutting length).....**\$1,059.00**
MBM1071 (28.5" cutting length).....**\$1,299.00**

1080 Triumph Large Format Trimmer

ITEM NO.

MBM1080

\$2,279⁰⁰



- 31.25" cutting length
- 20 sheet capacity, 5/32" height
- Solingen steel wide-angle blade
- Cuts matte, plastic, & metal foil
- Transparent Lexan safety guard
- Foot pedal positive clamping
- Precision side mm/inch guides

- Adjustable front & back gauge
- 32" x 24" metal table w/stand
- Fold-down extension table
- 1 year limited warranty
- 27" x 42" x 48" / 158 lbs

MBM1110 (43.75" cutting length).....**\$3,299.00**

4305 Triumph Manual Stack Cutter

ITEM NO.

MBM4305

\$2,119⁰⁰



**Shown w/ Options*



- 16-7/8" cutting length
- 1-1/2" cut height capacity
- Quality German steel blade
- Dual transparent safety guards
- Blade lever safety catch lock
- Patented fast-action clamp

- Safety Cutting System (CSC)
- Precision mm/inch side guide
- Spindle guided back gauge
- Calibrated crank and scale
- 1 year limited warranty
- 34.6" x 35.6" x 15.8" / 115 lbs

4315 Triumph Semi-Automatic Stack Cutter

ITEM NO.

MBM4315

\$5,049⁰⁰



- 16-7/8" cut length w/LED line
- 1-1/2" cut height capacity
- Quality German steel blade
- EASY CUT blade activation

- Electronic front safety guard
- Digital cm/inch display
- Switch & safety lock w/key
- Patented fast-action clamp

- Disc brake for instant stop
- Spindle guided back gauge
- 1 year limited warranty
- 34.3" x 25" x 14" / 191 lbs

MBM4350 (Fully Automatic).....**\$6,049.00**

MBM Trimmer Supplies

Item Code	Description	List
MBMAC0659C	1135 Knife Kit	\$129.00
MBMAC0660C	1134 Knife Kit	\$129.00
MBMAC0661C	1038 Knife Kit	\$159.00
MBMAC0662C	1046 Knife Kit	\$189.00
MBMAC0663C	1058 Knife Kit	\$209.00
MBMAC0665C	1071 Knife Kit	\$249.00
MBMAC0667C	1080 Knife Kit	\$419.00
MBMAC0669C	1110 Knife Kit	\$499.00

Call Your Sales Representative Today

1208P *ClassicCut Fixed Blade Trimmer*

ITEM NO.
SWIG7010007

\$34⁹⁹



- 12" cutting length
- 8 sheet capacity
- Compact and lightweight
- Trim safely and accurately
- Straight, double-bevel blade
- Plastic guide / safety barrier

- Letter size paper, photos, artwork
- Surface printed alignment guides
- Easy storage when not in use
- Sturdy, durable plastic base
- 1 year limited warranty
- 14.8" x 6" x 1.7"

1210W *ClassicCut Guillotine Trimmer*

ITEM NO.
SWIG7010001

\$91⁹⁹

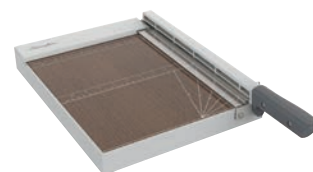

- 12" cutting length
- 10 sheet capacity
- Easy align with light guide
- EdgeGlow LED illumination
- Clear and accurate trimming

- Durable, solid wood surface
- Blade anchoring safety latch
- 3 AAA batteries included
- 5 year limited warranty
- 19.5" x 11.6" x 2.8"

9112 *ClassicCut® Pro Paper Trimmer*

ITEM NO.
SWI9112

\$124⁹⁹



- 12" cutting length
- 15 sheet capacity
- Durable wood 12" x 12" base
- Self-sharpening steel blade
- Protective guard rail

- Latch hook blade lock
- Alignment grid and ruler
- Non-slip rubber feet
- 10 yr warranty

SWI9115 (15" cutting length) **\$174.99**

1215G

ClassicCut Guillotine Trimmer

ITEM NO.
SWIG7010003

\$139⁹⁹

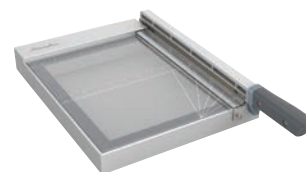

- 15" cutting length
- 15 sheet capacity
- Sleek and powerful
- EdgeGlow LED light guide
- Illuminates where cuts made
- Durable, tempered glass surface
- Printed with alignment guides

- Sturdy, secure plastic frame
- Not-in-use blade safety latch
- 3 AAA batteries included
- 5 year limited warranty
- 19.5" x 11.6" x 2.8"

1132 *ClassicCut® Ingento™ Paper Trimmer*

ITEM NO.
SWI1132

\$194⁹⁹



- 12" cutting length
- 15 sheet capacity
- Maple hardwood 12" x 12" base
- Tension spring secures handle
- Protective guard rail

- Latch hook blade lock
- Alignment grid and ruler
- Non-slip rubber feet
- 10 yr warranty

SWI1142 (15" cutting length) **\$294.99**

9612 *SmartCut® Heavy Duty Rotary Trimmer*

ITEM NO.
SWI9612

\$230⁹⁹

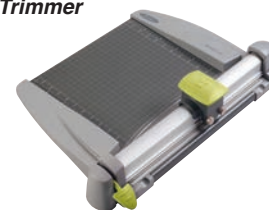

- 12" cutting length
- 30 sheet capacity
- Power and precision trimming
- Sturdy metal base, steel blade

- Transparent paper guide
- Manual clamp locks paper
- Alignment grid and ruler
- 1 year limited warranty

SWI9615 (15" cutting length) **\$259.99**

98150 *Low Force Guillotine Trimmer*

ITEM NO.
SWI98150

\$495⁹⁹



- 14" cutting length
- Up to 40 sheets at once
- Low force, less effort operation
- Sturdy metal 10.5" x 17.5" base

- Self-sharpening steel blade
- Removable ABS blade shield
- Auto clamp secures paper
- Alignment grid & dual ruler

- 1 year limited warranty
- 23" x 12" x 4" / 15 lbs

B5FC Novus® Flat Clinch Stapler

ITEM NO.
DAH020-1454

\$49⁹⁵



- Staples up to 50 sheets
- Gentle pressure easy operation
- Staples bend flat-better storage
- Steel driven mechanism
- Easy push button front loading
- Dual staple guide ensures feed

- Tri-Mode stapling capability
- German engineered for quality
- 25 year limited warranty
- 7.4" x 1.6" x 3" / 1 lb
- Uses: 24/6 or 24/8 Novus staples

DAH020-1480 (Blue).....\$49.95

B8FC Novus® Executive Flat Clinch Stapler

ITEM NO.
DAH020-1673

\$89⁹⁵



- Power on Demand!
- Requires 70% less effort
- Staples up to 50 sheets
- Fixed 2-5/8" throat depth
- Flat clinch or temporary pin
- Bypass system prevents overlap

- Push button loading release
- German engineered for quality
- 25 year limited warranty
- 8" x 2" x 4" / 1.5 lbs
- Uses: 24/6 or 24/8 Novus staples

B17 Novus® Long Arm Stapler

ITEM NO.
DAH020-1535

\$89⁹⁵



- Staples up to 40 sheets
- Adjust to 11-3/4" throat depth
- Guide has inch & metric scales
- Steel driven mechanism
- Dual guide encases the staples
- Flat clinch or temporary pin

- Push button front loading
- German engineered for quality
- 25 year limited warranty
- 16.5" x 2.4" x 2.8" / 1.7 lbs
- Uses: 24/6 or 24/8 Novus staples

B40 Novus® Heavy Duty Stapler

ITEM NO.
DAH023-0056

\$89⁹⁵



- Staples up to 100 sheets
- Anti-Blocking System
- Staple Bypass prevents overlap
- Adjustable staple depth guide
- Reliable dual staple guide
- Steel driven mechanism

- Easy top loading of staples
- Non-skid pads, heavy duty base
- 25 year limited warranty
- German engineered for quality
- 10.5" x 2.75" x 5.5" / 1.25 lbs
- Uses Novus 23 gauge staples

B50 Novus® Heavy Duty Stapler

ITEM NO.
DAH023-0060

\$149⁹⁵



- Staples up to 140 sheets
- Anti-Blocking System
- Staple Bypass prevents overlap
- Adjustable staple depth guide
- Reliable dual staple guide
- Steel driven mechanism

- Easy top loading of staples
- Non-skid pads, heavy duty base
- 25 year warranty
- German engineered for quality
- 13" x 3.5" x 8" / 3.2 lbs
- Uses Novus 23 gauge staples

B56 Novus® Heavy Duty Stapler

ITEM NO.
DAH023-0059

\$269⁹⁵



- Staples 20 to 210 sheets
- Anti-Blocking System
- Staple Bypass prevents overlap
- Adjustable staple depth guide
- Reliable dual staple guide
- Steel driven mechanism

- Easy top loading of staples
- Non-skid pads, heavy duty base
- 25 year limited warranty
- German engineered for quality
- 14.25" x 3.25" x 10.25" / 3.7 lbs
- Uses Novus 23 gauge staples

Dahle Stapler Supplies

Item Code	Size	Pack	List
DAH040-0026	24/6 Super 6mm	1,000	\$1.99
DAH040-0038	24/8 Super 8mm	1,000	\$4.99
DAH042-0040	23/8 Super 8mm	1,000	\$5.99
DAH042-0531	23/10 Super 10mm	1,000	\$6.49
DAH042-0533	23/13 Super 13mm	1,000	\$6.99
DAH042-0044	23/15 Super 15mm	1,000	\$7.49
DAH042-0045	23/17 Super 17mm	1,000	\$7.99
DAH042-0240	23/20 Super 20mm	1,000	\$8.99
DAH042-0644	23/24 Super 24mm	1,000	\$9.99

Call Your Sales Representative Today

HD-11FLKBK Compact Flat Clinch Stapler

ITEM NO.
MXBHD11FLKBK

\$24¹⁶



- Staples up to 35 sheets
- Fixed 1-1/8" throat depth
- 100 staples before reloading
- Made of 58% recycled plastic
- Twin lever mechanism
- Unique built-in remover

- Box of staples included
- 1 year limited warranty
- 1" x 4" x 3" / 6 oz
- Uses: MXB111M staples

HD-50DFBK Desktop Flat Clinch Stapler

ITEM NO.
MXBHD50DFBK

\$30⁹⁰

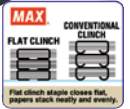

- Staples 2 to 30 sheets
- Fixed 3" throat depth
- 210 staples before reloading
- Ultra light touch closing action
- Twin lever reduces effort 30%

- Soft touch rubber top & base
- Available in black or gray
- 1 year limited warranty
- 2" x 7" x 3" / 1 lb
- Uses: MXB355M or 31M staples

MXBHD50DFGY (Gray).....**\$30.90**

HD-11UFL Vaimo 80 Flat Clinch Stapler

ITEM NO.
MXBHD11UFL

\$82¹⁸



- Staples 2 to 80 sheets
- Up to 1-1/4" adjustable throat
- 100 staples before reloading
- Push button loading release
- Unique 70% less effort design

- Heavy duty construction
- Contemporary red/brown
- 1 year limited warranty
- 2.5" x 8" x 6" / 24 oz
- Uses: MXB1180 staples

HD-3DF Manual Flat Clinch Heavy Duty Stapler

ITEM NO.
MXBHD3DF

\$115³⁵

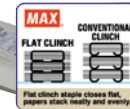

- Staples up to 75 sheets
- Ultra light touch closing action
- 100 staples before reloading
- One-touch loading mechanism
- Adjustable 1/5" to 2" throat

- High impact plastic frame
- 1 year limited warranty
- 3" x 12" x 7" / 4 lbs
- Uses: MXB310 or 31M staples

HD-12F Manual Flat Clinch Heavy Duty Stapler

ITEM NO.
MXBHD12F

\$163⁰⁰

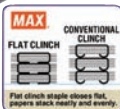

- Staples up to 150 sheets
- Ultra light touch closing action
- 100 staples before reloading
- One-touch loading mechanism
- Adjustable 1/5" to 1-3/4" throat
- High impact plastic frame

- Comfort rubber handle grip
- 3/8", 1/2", 9/16" or 5/8" staples
- 1 year limited warranty
- 3" x 12" x 9" / 4 lbs
- MXB121xFAH series staples

EH-20F Electronic Flat Clinch Stapler

ITEM NO.
MXBEH20F

\$205⁰⁰

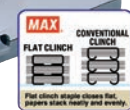

- Staples 2 to 20 sheets
- Easy snap-in staple cartridge
- 2,000 flat staples before reload
- Powerful & quiet motor driven
- Adjustable 1/8" to 3/5" throat
- User friendly jam clearing latch

- Auto shut-off when empty
- 1 year limited warranty
- 3" x 6.6" x 3" / 1.4 lbs
- Uses: MXBNO20FE staple ctgs

EH-70FII Electronic Flat Clinch Heavy Duty Stapler

ITEM NO.
MXBEH70FII

\$475⁰⁰



- Staples 2 to 70 sheets without changing staple size
- 5,000 flat staples before reload
- Manual or automatic operation
- Adjustable 1/4" to 3/4" depth
- Quiet motor driven mechanism
- Clear case for position viewing
- Status LED and corner guide

- Metal frame finger guard
- Restricted access to interlock
- Retrieve user manual from QR
- Stabilizing 4 point rubber grips
- 3 year limited warranty
- 9" x 4.5" x 4.5" / 3.3 lbs
- Uses: MXBNO70FE staple ctgs

EH-110F Professional Heavy Duty Electronic Flat Clinch Stapler

ITEM NO.
MXBEH110F

\$1,909⁹⁵



- Staples 2 to 100 sheets
- Easy snap-in staple cartridge
- 4,000 flat staples before reload
- Auto cutting staple legs
- Adjustable 1/8" to 7/8" throat
- User friendly jam clearing latch

- Paper table with guide lines
- LED indication lamp
- 1 year limited warranty
- 9.6" x 15.5" x 8.3" / 16.76 lbs
- Uses: MXBNO110FE staple ctgs

37201 Heavy Duty Staple Remover

ITEM NO.
SWIS7037201

\$16⁹⁹



- Designed for ease and comfort
- Removes all heavy duty staples
- Durable metal construction
- Spring-loaded lever handle

- Sturdy base for stability
- 1 yr warranty, 14 days return
- 1.9" x 5.7" x 3.4" / 8 oz

44401 Commercial Desk Stapler

ITEM NO.
SWIS7044401

\$32⁹⁹



- Reliable long-lasting design
- Staples up to 20 sheets
- Performance driven mechanism
- Durable metal construction
- Inner rail for jam-resistance
- Locking latch ensures control

- Opens for tacking flexibility
- Anvil rotates for pinning
- Lifetime limited warranty
- Strict 14 day return policy
- 2" x 7" x 2" / 1 lb
- Uses: SWI35450 1/4" staples

64601 Deluxe Desk Stapler

ITEM NO.
SWIS7064601

\$39⁹⁹



- Ideal for handheld applications
- Contoured, comfortable design
- Staples up to 20 sheets
- Antimicrobial protection
- Smooth form and finish
- Metal base and mechanism

- Opens for tacking flexibility
- Anvil rotates for pinning
- Lifetime limited warranty
- Strict 14 day return policy
- 1.9" x 7.5" x 2.5" / 1 lb
- Uses: SWI35450 1/4" staples

74701 Classic Stapler

ITEM NO.
SWIS7074701

\$42⁹⁹



- America's #1 manual stapler
- Simple yet classically designed
- Reliable, accurate and strong
- Staples up to 20 sheets
- Maximum durability metal
- Inner rail for long-term use
- Locking latch secures position

- Opens for tacking flexibility
- Anvil rotates for pinning
- 100% performance guaranteed
- Lifetime limited warranty
- Strict 14 day return policy
- 1.7" x 7.4" x 2.4" / 1 lb
- Uses: SWI35450 1/4" staples

74736 Rio Red Business Stapler

ITEM NO.
SWIS7074736

\$45⁹⁹



- Reliable stapler
- Well-recognized color
- Fun, functional, bold design
- 25 sheet stapling capacity
- Metal die cast construction
- Inner rail for jam-resistance

- Opens for tacking flexibility
- Anvil rotates for pinning
- Lifetime limited warranty
- Strict 14 day return policy
- 1.7" x 7.4" x 2.4" / 1 lb
- Uses: SWI35450 1/4" staples

SWIS7074741 (Black)..... **\$47.99**

64505 Quick Touch™ Stapler

ITEM NO.
SWIS7064505

\$50⁹⁹



- Lightweight for handheld use
- Stored energy system
- Reduced effort needed for use
- 2 to 20 sheets equally easy
- Powerful performance
- QuickLoad magazine refill
- Jam Free w/recommended staples

- Smooth, non-slip base
- Stylish black and gray
- 5 yr warranty, 14 day return
- 1" x 6.8" x 2.8" / 1 lb
- Uses: SWI35450 1/4" staples

585A Omnipress 30 Stapler

ITEM NO.
SWI5000585A

\$49⁹⁹



- Handheld or desktop use
- Ergonomic in-hand design
- One finger top press action
- Easy to use, reduced effort
- Staples up to 30 sheets

- Super flat clinch stapling
- Low staple indicator
- Durable plastic body
- Top spring loaded lid
- Inner metal construction

- Sturdy rubber base
- 5 year limited warranty
- 6.8" x 2.8" x 1.5" / 1 lb
- Uses SWI35450 1/4" staples

SWI5000586A (Black/Red)..... **\$49.99**

87845 Optima® 40 Reduced Effort Stapler

ITEM NO.
SWIS7087845

\$65⁹⁹



- Ergonomic shape, soft handle
- Handheld stand-up design
- Requires 50% less effort
- Staples 40 sheets at once
- Flat clinch operation
- Durable, inner-metal mechanism
- QuickLoad magazine refill

- Jam Free w/recommended staples
- 100% performance guarantee
- Lifetime limited warranty
- Strict 14 day return policy
- 1.8" x 7.8" x 3.4" / 2 lbs
- Uses: SWI35450 1/4" staples

SWIS7087842 (Compact version) **\$47.99**

87875 Optima® 70 Reduced Effort Stapler

ITEM NO.
SWIS7087875

\$99⁹⁹



- Staples up to 70 sheets
- Soft-grip material handle
- 50% less effort design
- Performance metal mechanism
- Flat clinch stapling
- Jam Free w/recommended staples

- QuickLoad magazine refill
- Lifetime limited warranty
- Strict 14 day return policy
- 2" x 9.5" x 5.5" / 2 lbs
- Uses: SWI35550 3/8" staples

39005 Heavy Duty Stapler

ITEM NO.
SWIS7039005

\$109⁹⁹



- Ideal for large stapling jobs
- Powers through 160 sheets
- 2-5/8" full throat depth
- Precision alignment guide
- Soft-touch material handle
- Durable metal construction
- Jam-clearing mechanism

- ".1/4", 3/8", 1/2" or 3/4" heavy-duty staples"
- Lifetime limited warranty
- Strict 14 day return policy
- 3.2" x 13.75" x 6.75" / 3 lbs
- Uses: 353xx heavy duty staples

90002 Heavy Duty High Capacity Stapler

ITEM NO.
SWIS7090002

\$191⁹⁹



- Built for lasting performance
- Impressive 210 sheet capacity
- 2-1/2" throat depth
- Adjustable alignment guide
- Soft-touch material handle
- Durable metal construction
- Jam-clearing mechanism

- ".1/4", 3/8", 1/2" or 3/4" heavy-duty staples"
- Lifetime limited warranty
- Strict 14 day return policy
- 3.75" x 16" x 8" / 5 lbs
- Uses: 353xx heavy duty staples

48200 Portable Electric Stapler

ITEM NO.
SWIS7048200

\$122⁹⁹



- Fast, convenient and flexible
- 20 sheet stapling capacity
- Precision adjustment guide
- Push button loading release

- Adapter or (6) "AA" batteries
- 2 yr warranty, 14 day return
- 2" x 8" x 4.6" / 1.7 lbs
- Uses: SWI35450 1/4" staples

42140 Speed Pro™ 25 Electric Stapler

ITEM NO.
SWIS7042140

\$139⁹⁹



- Fast, simple electric stapling
- Automatic staple insertion
- 1 step reduces risk of jams
- Sheet capacity indicator
- Staples up to 25 sheets

- Low staple indicator
- QuickLoad magazine refill
- Stays firm w/skid free base
- 7 yr warranty, 14 days return
- 2.8" x 9.6" x 4.6" / 1.8 lbs

SWIS7042141 (45 Sheet capacity) **\$225.99**

48209 Optima® 45 Electric Stapler Value Pack

ITEM NO.
SWIS7048209

\$265⁹⁹



- Fast, quiet and Jam Free
- Staples up to 45 sheets
- Automatic or manual modes
- Flat clinch mechanism
- Lit runway helps align paper
- Adjustable throat depth guide
- Built-in stack height gauge

- LED low staple indicator
- One button front load release
- Easy open storage drawer
- 100% performance guarantee
- 7 yr warranty, 14 day return
- 5.5" x 14" x 7" / 5 lbs
- Uses: SWI35450 1/4" staples

69008 Cartridge Electric Stapler

ITEM NO.
SWIS7069008

\$395⁹⁹



- For fast, high volume needs
- 30 sheet stapling capacity
- Patented cartridge technology
- 5,000 staples before reloading
- High performance engine
- Alignment guide

- Stable suction cup feet
- Prepacked with one cartridge
- 100% performance guarantee
- 2 yr warranty, 14 days return
- 4.3" x 11" x 7.6" / 4 lbs
- Uses: SWI50050 1/4" ctgs

Reliable
Affordable
Guaranteed



Superior Quality. Increased Profitability. Guaranteed.



NOW AVAILABLE!
NXT Technical Support Hotline for Resellers & End-users

The elephant in the room?

Others keep telling you that buying and selling their recycled toner is to your advantage, but NXT Premium Replacement Cartridges are quality-tested, performance certified cartridges that offer a Lifetime Warranty.

- 100% lifetime warranty
- Certified performance (ISO/STMC)
- Reduce printing costs up to 50%
- High quality new components
- Expanded U.S. distribution

www.NXTpremium.com

PLE20 *Multimedia Digital Projector*

ITEM NO.
EPSV11H981020

\$497⁰⁰



- 3400 lumens
- Poly-silicon TFT, 3LCD
- XGA 1024 x 768 pixels
- 15,000:1 contrast / 4:3 aspect
- 30" - 350" screen size
- Freeze, A/V mute, ECO mode
- Auto vertical keystone correct

- Split Screen, 5 watt speaker
- HDMI, USB, Serial
- PC, A/V, HDTV compatible
- 2 yr warranty, 90 days on lamp
- 11.8" x 9.8" x 3.6" / 6 lbs
- Uses: 210w UHE lamp

PLX49 *Multimedia Digital Projector*

ITEM NO.
EPSV11H982020

\$535⁰⁰



- 3600 lumens
- Poly-silicon TFT, 3LCD
- XGA 1024 x 768 pixels
- 16,000:1 contrast / 4:3 aspect
- 30" - 300" screen size
- Up to 50 users connection
- Freeze, A/V mute, ECO mode

- Auto vertical keystone correct
- Split Screen, Quick Corner
- HDMI, USB, Serial, RJ-45
- PC, network, HDTV compatible
- 2 yr warranty, 90 days on lamp
- 11.8" x 9.8" x 3.6" / 6 lbs
- Uses: 210w UHE lamp

PLW49 *Multimedia Widescreen Digital Projector*

ITEM NO.
EPSV11H983020

\$739⁰⁰



- 3800 lumens
- Poly-silicon TFT, 3LCD
- WXGA 1280 x 800 pixels
- 16,000:1 contrast / 16:10 aspect
- 30" - 320" screen size
- Up to 50 users connection
- Freeze, A/V mute, ECO mode

- Auto vertical keystone correct
- Split Screen, Quick Corner
- HDMI, USB, Serial, RJ-45
- PC, network, HDTV compatible
- 2 yr warranty, 90 days on lamp
- 11.8" x 9.8" x 3.6" / 6 lbs
- Uses: 210w UHE lamp

PL119W *Multimedia Widescreen Digital Projector*

ITEM NO.
EPSV11H985020

\$955⁰⁰



- 4000 lumens
- Poly-silicon TFT, 3LCD
- WXGA 1280 x 800 pixels
- 16,000:1 contrast / 16:10 aspect
- 33" - 320" screen size
- Up to 50 users connection
- Built-in 16 watt speaker
- Freeze, A/V mute, ECO mode

- Auto vertical keystone correct
- Split Screen, Quick Corner
- HDMI, USB, Serial, RJ-45
- PC, network, HDTV compatible
- 2 yr warranty, 90 days on lamp
- 11.8" x 9.8" x 3.6" / 6 lbs
- Uses: 210w UHE lamp

PL1286 *Multimedia Widescreen Business Projector*

ITEM NO.
EPSV11H846120

\$1,019⁰⁰



- 3,600 lumens
- 3LCD, 3-chip technology
- WUXGA 1920 x 1200 pixels
- 15,000:1 contrast / 16:10 aspect
- 30" - 300" screen size
- Auto vertical keystone correct

- Easy-slide image correction
- 2 HDMI, USB, WiFi
- PC, A/V, HDTV
- 2 yr warranty, 90 days on lamp
- 11.9" x 9.9" x 3.6" / 6.2 lbs
- Uses: 210w UHE lamp

PL1288 *Meeting Room Wireless Projector*

ITEM NO.
EPSV11H978120

\$1,062⁰⁰



- 4000 lumens
- 3LCD, 3-chip technology
- WXGA 1920 x 1080 pixels
- 16,000:1 contrast / 16:9 aspect
- 30" - 300" screen size
- Split Screen, ECO mode
- Auto vertical keystone correct
- Miracast wireless mirroring

- Built-in 16 watt speaker
- Freeze, A/V mute, e-zoom
- 2 HDMI, USB, WiFi LAN/direct
- PC, AV, HDTV, mobile able
- 1 yr warranty, 90 days on lamp
- 12" x 11.5" x 4" / 6 lbs
- Uses: 230w UHE lamp

PL982W *Widescreen Classroom Projector*

ITEM NO.
EPSV11H987020

\$1,085⁰⁰



- 4200 lumens
- Poly-silicon TFT, 3LCD
- WXGA 1280 x 800 pixels
- 16,000:1 contrast / 16:10 aspect
- 29" - 280" screen size
- Auto vertical keystone correct

- Moderator function, split screen
- Up to 50 users connection
- Built-in 16 watt speaker
- Freeze, A/V mute, ECO mode
- 2 HDMI, USB, Serial, RJ-45

- Project from mobile devices
- PC, network, HDTV compatible
- 2 yr warranty, 90 days on lamp
- 12" x 11.5" x 4" / 6.8 lbs
- Uses: 230w UHE lamp

72353 *Wireless Presenter Pro w/Laser Pointer*

ITEM NO.
KMW72353

\$108⁹⁹



- 2.4GHz wireless technology
- Extended range up to 150 feet
- Ultra bright green laser beam
- Intuitive four button design

- Low battery indicator
- Plug-n-play simplicity
- Powerpoint® & Keynote®
- Protective carrying case

- 2 "AAA" batteries included
- 2 yr warranty, 14 days return
- 2" x 4" x 1" / 5 oz

PROJECTION PRODUCTS



MP-600 *Mini Keychain Laser Pointer*

ITEM NO.
QRTMP600Q

\$35⁰⁰



- More powerful than it looks
- Class 3a strong laser beam
- Suitable for large venues
- Small 2" compact design
- Keychain attachment
- Hook onto purse or pocket

- Brilliant red laser dot
- 600 to 1148 ft projection range
- Black high-impact plastic case
- 2-LR44 batteries included
- 1 yr warranty, 14 days return

84501 *Slim Line Laser Pointer*

ITEM NO.
QRT84501

\$41⁰⁰



- Class II, card-style design
- Pocket-sized packs a punch
- Long range up to 655 feet
- Projects highly visible red dot
- Designed for small venues
- Visible in all room conditions

- Matte black w/silver accent
- 1 "CR2032" battery included
- 100% satisfaction guaranteed

MP-2703 *Classic Comfort Grip Laser Pointer*

ITEM NO.
QRTMP2703G2Q

\$64⁰⁰



- Enrich presentations
- Class 2 laser beam
- Anti-slip design
- Rubberized cushion grip

- Highly visible red laser dot
- 655 ft projection distance
- Graphite gray exterior
- 2-AAA batteries included

- 100% satisfaction guaranteed
- 1 yr warranty, 14 days return

MP-2800 *4-in-1 Executive Laser Pointer*

ITEM NO.
QRTMP2800Q

\$85⁵⁰



- Traveling professionals tool
- Multi-function pen-style design
- Ballpoint pen, stylus & LED light
- Underline & create strobe effect

- Class 2 bright red laser beam
- Visible in most room conditions
- 450 to 919 ft projection distance
- Durable for frequent use

- All metal silver exterior
- 4-LR41 batteries included
- 100% satisfaction guaranteed
- 1 yr warranty, 14 days return

Call Your Sales Representative Today

NA3624F Fusion Nano-Clean Whiteboard

ITEM NO.
QRTNA3624F

\$199⁹⁹



- 3' x 2' magnetic surface
- Nano-Clean™ technology
- Ghosting & stain resistant

- Recessed smooth surface
- Fresh clean look
- Silver aluminum frame

- Mounts vertical or horizontal
- 25 yr warranty, 14 days return
- 3" x 2" x .75" / 5 lbs

QRTNA4836F (4' x 3') **\$367.99**
QRTNA7248F (6' x 4') **\$662.99**

QRTNA9648F (8' x 4') **\$887.99**

560S Portable Tripod Projection Screen

ITEM NO.
QRT560S

\$349⁹⁹



- High resolution 60" x 60" size
- Crisp matte white surface
- Keystone correction system
- Retracts on smooth-roll springs
- Flame proof & mildew resistant
- Lightweight for portability

- Quick set-up sturdy metal legs
- Durable steel carrying case
- 100% satisfaction guaranteed
- 70.75" x 7.4" x 5" / 23.9 lbs

QRT570S (70" x 70") **\$515.99**

684S Wall/Ceiling Projection Screen

ITEM NO.
QRT660S

\$625⁹⁹



- High resolution 84" x 84" size
- Matte white fiberglass surface
- Easily secure to wall or ceiling
- Reliable screen retract springs
- Flame proof & mildew resistant

- Versatile, dependable, durable
- Stows away when not in use
- Heavy duty black metal case
- 100% satisfaction guaranteed
- 90" x 5" x 4" / 48 lbs

QRT660S (60" x 60") **\$270.99**
QRT670S (70" x 70") **\$340.99**

85568 Widescreen Tripod Projection Screen

ITEM NO.
QRT85568

\$422⁹⁹



- Suitable for professional use
- High resolution 52" x 92" size
- Crisp matte white vinyl surface
- Wide format 16:9 aspect ratio
- Still, video images, TV, movies
- Clear viewing from any angle

- Keystone eliminators
- Quick set-up sturdy metal legs
- Portable steel carrying case
- 5 yr warranty, 14 days return
- 102" x 7.9" x 5" / 32 lbs

85573 Wall Mount Projection Screen

ITEM NO.
QRT85573

\$594⁹⁹



- Optimizes still & video images
- High resolution 65" x 116" size
- Crisp matte white vinyl surface
- Wide format 16:9 aspect ratio
- Adjustable viewing height
- Clear viewing from any angle

- Easily secure to wall or ceiling
- No valuable floor space taken
- Stows away when not in use
- 5 yr warranty, 14 days return
- 127" x 6.9" x 6" / 41 lbs

980S Instant Cinema Projection Screen

ITEM NO.
QRT980S

\$1,580⁹⁹



- For cinema-quality presentations
- Sleek chic Modern Euro design
- High-contrast clear picture
- Lightweight and portable
- Easy one handed set-up
- Expands from 50" - 74" high

- Flame proof & mildew resistant
- Locking feet hold screen in place
- Sturdy stylish carrying case
- 100% satisfaction guaranteed
- 69" x 5.5" x 4.8" / 22 lbs

AW6Q Projection Screen Wall Brackets

ITEM NO.
QRTAW6Q

\$36⁹⁹



- Extends screens 6" from wall
- Hang in front of existing tools
- Cover writing & blackboards
- More efficient use of space

- Easy two-screw installation
- 100% satisfaction guaranteed
- 2 per package

TC Tape Size Guide*

Find your P-touch model in the list below to see all the tape sizes it can use!

Models	9mm (3/8")	12mm (1/2")
	PT-6, 8, 10, 12, 12N, 15, 20, 25, 150, 170	
*25.26' (7.7m) long		

9mm (3/8")*	Description	Pkg	List
TC-20Z1	Black / White	EA	\$21.99
TC-34Z	White / Black	PK/2	\$39.99
TC-14Z1	White / Clear	EA	\$22.99
12mm (1/2")*			
TC-6001	Black / Blue	EA	\$21.99
TC-10	Black / Clear	PK/2	\$39.99
TC-8001	Black / Green	EA	\$21.99
TC-5001	Black / Red	EA	\$21.99
TC-20	Black / White	PK/2	\$39.99
TC-7001	Black / Yellow	EA	\$21.99
TC-33	Gold / Black	PK/2	\$44.99
TC-21	Red / White	PK/2	\$39.99

M Tape Size Guide*

Find your P-touch model in the list below to see all the tape sizes it can use!

Models	9mm (3/8")	12mm (1/2")
	PT-65, 70, 80, 85, 90, 100, 110	
*26.25' (8m) long		

9mm (3/8")*	Description	Pkg	List
M-821	Black / Gold	EA	\$9.49
M-721	Black / Green	EA	\$9.49
M-E21	Black / Pink	EA	\$9.49
M-921	Black / Silver	EA	\$9.49
12mm (1/2")*			
M-531	Black / Blue	EA	\$10.49
M-131	Black / Clear	EA	\$10.49
M-831	Black / Gold	EA	\$10.49
M-731	Black / Green	EA	\$10.49
M-E31	Black / Pink	EA	\$10.49
M-931	Black / Silver	EA	\$10.49
M-231	Black / White	EA	\$10.49
M-2312PK	Black / White	PK/2	\$19.49
M-K631	Black / Yellow	EA	\$10.49
M-K233	Blue / White	EA	\$10.49
M-K232	Red / White	EA	\$10.49

TX Tape Size Guide*

Find your P-touch model in the list below to see all the tape sizes it can use!

Models	(6mm) 1/4"	12mm (1/2")	18mm (3/4")	24mm (1")
	PT-30, 35, 8000, PTPC			
*49.21' (15m) long				

6mm (1/4")*	Description	Pkg	List
TX-2111	Black / White	EA	\$34.99
12mm (1/2")*			
TX-1311	Black / Clear	EA	\$39.99
TX-4311	Black / Red	EA	\$39.99
TX-2311	Black / White	EA	\$39.99
TX-6311	Black / Yellow	EA	\$39.99
TX-2321	Red / White	EA	\$39.99
TX-3351	White / Black	EA	\$44.99
18mm (3/4")*			
TX-1411	Black / Clear	EA	\$44.99
TX-2411	Black / White	EA	\$44.99
24mm (1")*			
TX-5511	Black / Blue	EA	\$44.99
TX-B511	Black / Fluorescent Orange	EA	\$66.99
TX-7511	Black / Green	EA	\$44.99
TX-4511	Black / Red	EA	\$44.99
TX-2511	Black / White	EA	\$44.99
TX-6511	Black / Yellow	EA	\$44.99
TX-3551	White / Black	EA	\$51.49

*** TAPE MEASUREMENTS ARE APPROXIMATE ***

TZe Tape Size Guide*

Find your P-touch model in the list below to see all the tape sizes it can use!

Models	3.5mm (9/64")	6mm (1/4")	9mm (3/8")	12mm (1/2")	18mm (3/4")	24mm (1")	36mm (1-1/2")		
	PT-1010, 1090, 1230PC, 1280, 1290, D210, E100, H110								
	PT-1830, 1880, 2030, 2030AD, 2030VP, 2100, 2110, E300, D400AD, D400VP, H300, H300LI								
	PT-2430PC, 2700, 2710, 2730, 2730VP, H500LI, P700, P750W								
	GL-100, PT-200, 1000, 1100, 1100SB, 1120, 1130, 1160, 1170S, 1180, 1190, 1200, ST-1150, 1150DX								
PT-18R, 300, 310, 320, 340, 1300, 1700, 1750, 1760, 1800, 1810, 1900, 1910, 1950, 1960, ST-5									
PT-330, 350, 520, 540, 580C, 1400, 1500PC, 1600, 1650, 2200, 2210, 2300, 2310, 2400, 2410, 2500PC, 2600, 2610, 7500, 7600									
* 26.25' (8m) long		PT-530, 550, 3600, 9200DX, 9200PC, 9400, 9500PC, 9600							

3.5mm (9/64")*	Description	Pkg	List
TZe-N201	Black / White	EA	\$16.99
6mm (1/4")*			
TZe-111	Black / Clear	EA	\$13.99
TZe-211	Black / White	EA	\$15.99
TZe-S211	Black / White - Strong Adhesive	EA	\$16.99
TZe-315	White / Black	EA	\$18.99
9mm (3/8")*			
TZe-121	Black / Clear	EA	\$15.99
TZe-S121	Black / Clear - Strong Adhesive	EA	\$18.99
TZe-421	Black / Red	EA	\$17.99
TZe-221	Black / White	EA	\$17.99
TZe-S221	Black / White - Strong Adhesive	EA	\$18.99
TZe-S621	Black / Yellow - Strong Adhesive	EA	\$18.99
TZe-325	White / Black	EA	\$19.99
12mm (1/2")*			
TZe-131	Black / Clear	EA	\$17.99
TZe-1312PK	Black / Clear	PK/2	\$33.49
TZe-S131	Black / Clear - Strong Adhesive	EA	\$19.99
TZe-231	Black / White	EA	\$18.99
TZe-2312PK	Black / White	PK/2	\$34.99
TZe-AF231	Black / White - Acid Free	EA	\$19.99
TZe-FX231	Black / White - Flex ID	EA	\$19.99
TZe-S231	Black / White - Strong Adhesive	EA	\$19.99
TZe-631	Black / Yellow	EA	\$18.99
TZe-FX631	Black / Yellow - Flex ID	EA	\$19.99
TZe-S631	Black / Yellow - Strong Adhesive	EA	\$19.99
TZe-FA3	Blue / White - Iron On	EA	\$26.49
TZe-334	Gold / Black	EA	\$21.99
TZe-232	Red / White	EA	\$18.99
TZe-335	White / Black	EA	\$21.99
TZe-135	White / Clear	EA	\$18.99
TZe-S135	White / Clear - Strong Adhesive	EA	\$19.99
TZe-MQG35	White / Lime Green	EA	\$14.99
TZe-MQP35	White / Berry Pink	EA	\$14.99
TZe-MQ934	White / Satin Silver	EA	\$19.99
18mm (3/4")*			
TZe-541	Black / Blue	EA	\$21.99
TZe-141	Black / Clear	EA	\$19.99
TZe-S141	Black / Clear - Strong Adhesive	EA	\$23.49
TZe-B41	Black / Fluorescent Orange*	EA	\$26.49

18mm (3/4")*	Description	Pkg	List
TZe-741	Black / Green	EA	\$21.99
TZe-441	Black / Red	EA	\$21.99
TZe-S941	Black / Silver - Strong Adhesive	EA	\$27.49
TZe-241	Black / White	EA	\$21.99
TZe-FX241	Black / White - Flex ID	EA	\$23.49
TZe-SE4	Black / White - Security	EA	\$31.49
TZe-S241	Black / White - Strong Adhesive	EA	\$23.49
TZe-641	Black / Yellow	EA	\$21.99
TZe-S641	Black / Yellow - Strong Adhesive	EA	\$23.49
TZe-243	Blue / White	EA	\$21.99
TZe-344	Gold / Black	EA	\$25.49
TZe-242	Red / White	EA	\$21.99
TZe-345	White / Black	EA	\$25.49
TZe-545	White / Blue	EA	\$25.99
TZe-145	White / Clear	EA	\$21.99
TZe-CL4	Cleaning tape	EA	\$21.99
24mm (1")*			
TZe-151	Black / Clear	EA	\$24.49
TZe-S151	Black / Clear - Strong Adhesive	EA	\$27.49
TZe-B51	Black / Fluorescent Orange*	EA	\$31.49
TZe-451	Black / Red	EA	\$25.49
TZe-S951	Black / Silver - Strong Adhesive	EA	\$29.99
TZe-251	Black / White	EA	\$25.49
TZe-FX251	Black / White - Flex ID	EA	\$27.99
TZe-S251	Black / White - Strong Adhesive	EA	\$27.49
TZe-651	Black / Yellow	EA	\$25.49
TZe-FX651	Black / Yellow - Flex ID	EA	\$27.99
TZe-S651	Black / Yellow - Strong Adhesive	EA	\$27.49
TZe-354	Gold / Black	EA	\$28.49
TZe-252	Red / White	EA	\$25.49
TZe-355	White / Black	EA	\$28.49
36mm (1-1/2")*			
TZe-161	Black / Clear	EA	\$29.49
TZe-S961	Black / Silver - Strong Adhesive	EA	\$37.99
TZe-261	Black / White	EA	\$29.49
TZe-FX261	Black / White - Flex ID	EA	\$34.99
TZe-S261	Black / White - Strong Adhesive	EA	\$34.99
TZe-661	Black / Yellow	EA	\$29.49
TZe-S661	Black / Yellow - Strong Adhesive	EA	\$34.99
TZe-CL6	Cleaning tape	EA	\$29.49

* TAPE MEASUREMENTS ARE APPROXIMATE *

PT-70BM *Personal Handheld Label Maker*

ITEM NO.
BRTPT70BM

\$49⁹⁵



- Ideal for home use
- QWERTY keyboard
- 8 character x 1 line LCD
- 1 font, up to 2 line printing
- 2 font sizes, 9 type styles
- 5 auto formats, 5 frames

- Time and date function
- Text framing & underlining
- 4-AAA batteries not included
- 1 yr warranty, 30 days return
- 6.6" x 4.3" x 2.3" / 1 lb
- Uses: M tapes (9 or 12mm)

PT-M95 *Simply Stylish Personal Labeler*

ITEM NO.
BRTPTM95

\$50⁹⁵



- 12 character x 1 line LCD
- 1 font, up to 2 line printing
- 9 type styles, 10 frames
- 8 Deco Mode patterns
- 210 built-in symbols

- 4-AAA batteries not included
- 1 yr warranty, 30 days return
- 6" x 4.4" x 2.4" / 10 oz
- Uses: M tapes (9 or 12mm)

PT-H110 *Easy, Handheld Label Maker*

ITEM NO.
BRTPTH110

\$58⁹⁵



- 15 character x 1 line LCD
- 3 fonts, up to 2 line printing
- 10 type styles, 14 frames
- 17 Deco Mode patterns
- 9 auto design formats
- 253 built-in symbols
- Store up to 15 favorites

- 6-AAA batteries not included
- Optional adapter available
- 1 yr warranty, 30 days return
- 4.3" x 2.2" x 8" / 1 lb
- TZe tapes 3.5, 6, 9 or 12mm

PT-H111 *Pro Handheld Label Maker*

ITEM NO.
BRTPTH111

\$95⁹⁵



- Ideal for industrial work
- 15 character x 1 line LCD
- 3 fonts, up to 2 line printing
- 3 font sizes, 10 type styles
- 2 text frames, 9 copies
- QWERTY keyboard
- Integrated cutter

- 300+ built-in symbols
- Store up to 9 favorites
- 6-AAA batteries not included
- AC power adapter optional
- 1 yr warranty, 30 days return
- 4.3" x 2.2" x 8" / 1 lb
- TZe tapes 6, 9 or 12mm

PT-D210 *Easy-to-Use Home Office Labeler*

ITEM NO.
BRTPTD210

\$58⁹⁵



- 15 character x 1 line LCD
- 14 fonts, up to 2 line printing
- 10 type styles, 97 frames
- 17 Text designs
- 10 Pattern designs
- 617 built-in symbols

- Store up to 30 favorites
- 6-AAA batteries not included
- Optional adapter available
- 1 yr warranty, 30 days return
- TZe tapes 3.5, 6, 9 or 12mm

PT-D400AD *Easy-to-Use Labeler with AC Adapter*

ITEM NO.
BRTPTD400AD

\$97⁹⁵



- View text w/graphical display
- Top loading tape design
- 14 fonts, up to 5 line printing
- 10 type styles, 99 frames
- Auto numbering, repeat print
- Built-in 50 label memory

- Symbols, templates, barcodes
- AD-E001 adapter included
- 6-AA batteries not included
- 2 yr warranty, 30 days return
- 7.4" x 7" x 2.8" h / 1.6 lbs
- TZe 3.5, 6, 9, 12 or 18mm

BRTPTD202 (Batteries included) **\$95.95**

BRTPTD400VP (w/ Carry case) **\$145.95**

PT-H300 *Take-It-Anywhere Labeler*

ITEM NO.
BRTPTH300

\$121⁹⁵



- 3 line Vivid Bright display
- 14 fonts, up to 5 line printing
- 10 type styles, 8 sizes
- 617 symbols, 9 bar codes
- 25 built-in design formats
- Auto numbering, 9 repeats
- 50 label internal memory

- One-touch keys, manual cutter
- Battery & adapter optional
- 6-AA batteries included
- 2 yr warranty, 30 days return
- 5.2" x 8.4" x 2.6" / 1.5 lbs
- TZe tapes 3.5, 6, 9, 12 or 18mm

BRTPTH300LI (w/ Rechargeable battery) **\$156.95**

PT-H500LI *Rechargeable Take-It-Anywhere Labeler*

ITEM NO.
BRTPTH500LI

\$240⁹⁵



- 3 line Vivid Bright display
- 14 fonts, up to 7 line printing
- 10 type styles, 99 frames
- 617 symbols, 9 bar codes
- 25 built-in design formats
- Auto numbering, 99 repeats
- 50 label internal memory

- USB (Windows, Mac)
- Battery & adapter included
- 6-AA batteries optional
- 2 yr warranty, 30 days return
- 5.2" x 2.6" x 8.4" / 1.5 lbs
- TZe 3.5, 6, 9, 12, 18 or 24mm

PT-P300BT *CUBE Bluetooth Label Maker*

ITEM NO.
BRTPTP300BT

\$93⁹⁵



- Print from phone or tablet
- 2 line thermal transfer
- Up to 20mm per second
- Bold, Italic type styles
- Google & Apple fonts
- 180 dpi, 450+ symbols
- 60 text frame types
- Up to 30 built-in templates

- Left, center, right, justified
- Vertical print, manual cutter
- Free Design&Print app
- AC battery included
- 1 yr warranty, 30 days return
- 4.6" x 4.6" x 2.5" / 1 lb
- Tze tapes 3.5, 6, 9 or 12mm

PT-P700 *PC-Connectable Label Maker*

ITEM NO.
BRTPTP700

\$108⁹⁵



- Plug & Label™ technology
- Graphics & multi-line printing
- TrueType® fonts via PC
- Auto numbering, multi-copy
- Fast print speeds, auto cutter
- Templates from Cloud
- P-touch Editor software

- USB (Windows, Mac)
- Cables, software included
- 6-AA batteries optional
- 2 yr warranty, 30 days return
- 3" x 6" x 5.6" / 1.6 lbs
- TZe 3.5, 6, 9, 12, 18 or 24mm

PT-D450 *PC-Connectable Label Maker*

ITEM NO.
BRTPTD450

\$129⁹⁵



- 2 line graphical display
- 14 fonts, up to 5 line printing
- 10 type styles, 8 sizes
- 617 symbols, 25 designs
- Auto numbering, repeat print
- Manual cutter; 9 barcodes
- Store up to 50 favorites

- USB (Windows, Mac)
- AD-E001 adapter included
- 6-AA batteries not included
- 2 yr warranty, 30 days return
- 7.4" x 7" x 2.8" / 1.6 lbs
- TZe 3.5, 6, 9, 12 or 18mm

PT-D600 *Professional Labeling System*

ITEM NO.
BRTPTD600

\$161⁹⁵



- Full color graphical display
- 14 fonts, up to 7 line printing
- 11 type styles, 99 frames
- Built-in templates, auto cutter
- 99 label memory, 9 barcodes
- Auto numbering, repeat print

- USB (Windows, Mac)
- 6-AA batteries not included
- AD-E001 adapter included
- 2 yr warranty, 30 days return
- 7.9" x 7.6" x 3.4" / 2 lbs
- TZe 3.5, 6, 9, 12, 18 or 24mm

BRTPTD600VP (w/ Carry case).....\$275.95

PT-P710BT *CUBE Plus Wireless Label Maker*

ITEM NO.
BRTPTP710BT

\$195⁹⁵ 



- Print from PC, phone, tablet
- Bluetooth wireless tech
- Design&Print2, iPrint&Label
- 4 line thermal transfer
- Up to 30mm per second
- True Type font styles
- 100 stored labels, 99 copies
- 146 text frame types

- Over 330 design templates
- 3,452 built-in symbols
- Vertical print, Barcoding
- Battery & USB included
- 1 yr warranty, 30 days return
- 5" x 2.6" x 5" / 1.4 lbs
- Tze tapes 3.5, 6, 9, 12, 24mm

PT-P750W *Compact PC Label Maker w/Wireless Printing*

ITEM NO.
BRTPTP750W

\$208⁹⁵



- Plug & Label™ technology
- Graphics, barcode, logo print
- TrueType® fonts & symbols
- Auto numbering, multi-copy
- Fast print speeds, auto cutter
- Cloud templates, PT Editor
- iPrint&Label app
- Mobile device enabled

- USB, WiFi, NFC (Win/Mac)
- Cables, software included
- AC adapter included
- Optional battery operation
- 2 yr warranty, 30 days return
- 3" x 6" x 5.6" / 1.8 lbs
- TZe 3.5, 6, 9, 12, 18 or 24mm

PT-P910BT *CUBE XP Wireless Label Maker*

ITEM NO.
BRTPTP910BT

\$575⁹⁵ 



- Print from PC, phone, tablet
- Bluetooth wireless +USB
- Design&Print2, iPrint&Label
- Spellcheck & voice to text
- Creat & share QR codes
- 17 line thermal transfer
- Up to 30mm per second
- True Type font styles
- 100 stored labels, 99 copies

- 146 text frame types
- Over 330 design templates
- 3,452 built-in symbols
- Vertical print, Barcoding
- Built-in battery and cutter
- 1 yr warranty, 30 days return
- 5" x 2.6" x 5" / 1.4 lbs
- Tze 3.5, 6, 9, 12, 24, 36mm

PT-P900W *Desktop Barcode Label Printer*

ITEM NO.
BRTPTP900W

\$570⁹⁵



- Laminated thermal transfer
- Fast printing up to 2.3 ips
- Text, graphics and barcodes
- High quality 360 x 720 dpi
- Fast print speeds, auto cutter
- Cloud templates, PT Editor
- Simple drop-in tape design

- Mobile device enabled
- USB, WiFi, Serial (Windows, Mac)
- Cables, software included
- Optional battery operation
- 2 yr warranty, 30 days return
- 4.7" x 7.6" x 5.7" / 3.3 lbs
- Tze or HGe 3.5 to 36mm tapes

BRTPTP950NW (w/ Network)\$705.95

QL-600 *Economic Label Maker*

ITEM NO.
BRTQL600

\$257⁹⁵



- Up to 44 labels/minute
- Crisp 300 x 600 dpi
- True Type fonts
- 1379 clipart symbols
- Length & alignment settings
- Date/Time stamp support
- Vertical, mirror, rotate print

- Built-in automatic cutter
- Free P-Touch editor software
- USB (Windows, Mac, Linux)
- 2 yr warranty, 30 days return
- 8.8" x 6" x 5" / 2.5 lbs
- Uses: DK tapes and labels

QL-800 *High-Speed Professional Label Printer*

ITEM NO.
BRTQL800

\$164⁹⁵



- Accepts up to 2.4" wide labels
- Crisp 300 x 600 dpi resolution
- Editor Lite Plug & Label feature
- Ultra fast up to 93 labels/minute
- Pre-designed label collection
- Built-in automatic cutter

- pbSmartPostage™ printing
- USB (Windows, Mac)
- Cable, software included
- 1 yr warranty, 30 days return
- 5" x 8.7" x 6" / 2.5 lbs
- Uses: DK tapes and labels

QL-820NWB *Professional, Ultra Flexible Label Printer for Business*

ITEM NO.
BRTQL820NWB

\$412⁹⁵



- Accepts up to 2.4" wide labels
- PC or stand alone operation
- Crisp 300 x 600 dpi resolution
- Ultra fast up to 110 labels/minute
- Pre-designed label collection
- Built-in automatic cutter

- Mobile device compatible
- Free iPrint&Label app
- USB, Ethernet, Bluetooth, WiFi
- 1 yr warranty, 30 days return
- 5" x 5.7" x 9.2" / 2.5 lbs
- Uses: DK tapes and labels

QL-1110NWB *Wide Format Label Printer w/Wireless Network*

ITEM NO.
BRTQL1110NWB

\$446⁹⁵



- Prints on labels up to 4" wide
- PC or stand alone operation
- Sharp 300 dpi resolution
- Up to 69 labels/minute
- TrueType® fonts via PC
- Built-in automatic cutter

- Mobile device compatible
- Free iPrint&Label app
- USB, Ethernet, Bluetooth, WiFi
- 2 yr warranty, 30 days return
- 6.7" x 8.7" x 6" / 3.9 lbs
- Uses: DK tapes and labels

BROTHER - ACCESSORIES - DK Tapes/Labels

QL500 * 570 * 580N * 600 * 700 * 710W * 720NW * 800 * 810W * 820NWB * 1060N * 1110NWB			
Item	Description	Pkg	List
DK-2214	Narrow White Paper Tape 0.47" x 100'	Roll	\$14.99
DK-2210	Medium White Paper Tape 1.1" x 100'	Roll	\$19.99
DK-N5224	Non-Adhesive White Paper Tape 2.1" x 100'	Roll	\$19.99
DK-2205	Wide White Paper Tape 2.4" x 100'	Roll	\$28.99
DK-4205	Wide White Paper Tape 2.4" x 100' - Removable	Roll	\$38.99
DK-2243	Wide White Paper Tape 4" x 100' (1110NWB only)	Roll	\$51.49
DK-2211	Medium White Film Tape 1.1" x 50'	Roll	\$32.49
DK-2212	Wide White Film Tape 2.4" x 50'	Roll	\$64.99
DK-2113	Wide Clear Film Tape 2.4" x 50'	Roll	\$99.99
DK-1203	File Folder Labels 0.66" x 3.4"	Pk/300	\$13.49
DK-1204	Multi-Purpose Labels 0.66" x 2.1"	Pk/400	\$15.99
DK-1219	Round Paper Labels 0.47" Diameter	Pk/1200	\$20.99
DK-1218	Round Paper Labels 0.94" Diameter	Pk/1000	\$20.99
DK-1221	Square Address Labels 0.9" Diameter	Pk/1000	\$20.99
DK-1209	Small Address Labels 1.1" x 2.4"	Pk/800	\$27.99
DK-1201	Standard Adress Labels 1.1" x 3.5"	Pk/400	\$15.99
DK-1208	Large Address Labels 1.4" x 3.5"	Pk/400	\$20.99
DK-1202	Small Shipping Labels 2.4" x 3.9"	Pk/300	\$27.99
DK-1207	CD/DVD Film Labels 2.2" Diameter	Pk/100	\$29.99

Call Your Sales Representative Today

PER7T Personal Surge Arrest

ITEM NO.
APWPER7T

\$30⁰⁰



- 7 outlets, 1 Telco, 6' cord
- 240 joules / 120 V
- Protects modem, fax, DSL
- Two wire, single line jacks
- Fail safe disconnect mode
- Site wiring fault indicator

- EMI/RFI noise filtering
- CSA and UL approved
- \$50,000 protection policy
- Lifetime product warranty
- 10.5" x 4" x 2" / 1.8 lbs

PH12 Home Office Surge Arrest

ITEM NO.
APWPH12

\$32⁰⁰



- 12 outlets, transformer spacing
- 6' cord with right angle plug
- 2160 joules / 120 V
- For computers and electronics
- Building wire fault indicator
- Fail safe disconnect mode

- EMI/RFI noise filtering
- CSA and UL approved
- \$150,000 protection policy
- Lifetime product warranty
- 12.1" x 3.1" x 1.2" / 1.5 lbs

APWPH8 (8 outlets) **\$26.00**

BE425M Battery Back-UPS

ITEM NO.
APWBE425M

\$76⁰⁰



- 6 outlets, 5' cord
- 425 VA / 255 Watts
- 18 min. half-load runtime
- Protects modem, fax, DSL
- User replaceable batteries
- Building wiring fault indicator

- Status LED, audible alarms
- Multi-pole noise filtering
- RoHS and UL approved
- \$75,000 protection policy
- 3 year product warranty
- 10" x 5.5" x 4.1" / 6 lbs

APWBE600M1 (7 outlets, 600 VA) **\$111.00**

BK350 Battery Back-UPS CS

ITEM NO.
APWBK350

\$133⁰⁰



- 6 outlets, 6' cord
- 350 VA / 210 Watts
- 21 min. half-load runtime
- Protects modem, fax, DSL
- User replaceable batteries
- Building wiring fault indicator

- Status LED; audible alarms
- Multi-pole noise filtering
- PowerChute software
- USB, Serial ports
- \$100,000 protection policy
- 3 year product warranty
- 3.6" x 11" x 6.5" / 12.5 lbs

APWBK500 (500 VA / 300 Watts) **\$180.00**

BR700G Battery Back-UPS RS

ITEM NO.
APWBR700G

\$188⁰⁰



- 6 outlets, 6' cord
- 700 VA / 420 Watts
- 13 min. half-load runtime
- Protects modem, fax, DSL
- Base-T, Co-axial video/cable
- Automatic voltage regulation
- LCD panel; audible alarms

- Energy saving auto-off
- PowerChute software
- USB, Serial ports
- \$150,000 protection policy
- 3 year product warranty
- 3.6" x 12" x 7.5" / 15.7 lbs

APWBR1500MS (10 Outlets / 900 Watts) **\$340.00**

SMT1000C Battery Back Smart-UPS System

ITEM NO.
APWSMT1000C

\$676⁰⁰



- 8 outlets, 6' cord
- 1000 VA / 670 Watts
- 20.6 min. half-load runtime
- Server and network protection
- Automatic voltage regulation
- High-efficiency green mode

- Interactive LCD display panel
- Multi-pole noise filtering
- USB, Serial, Smart ports
- \$150,000 protection policy
- 3 yr warranty, 2 yrs on battery
- 6.7" x 17" x 8.5" / 42 lbs

APWSMT1500C (1440VA / 1000 Watts) **\$831.00**

Kensington

SURGE PROTECTORS

K62147 SmartSockets® Standard Strip Surge Suppressor

ITEM NO.
KMWK62147

\$60⁰⁰

- 6 color coded outlets
- 7' cord with right angle plug
- 450 joules / 120 V

- Protects electronic equipment
- Matching labels manage cords
- EMI/RFI noise filtration

- \$15,000 limited protection
- Lifetime product warranty
- 2" x 11" x 2" / 1.8 lbs



Power360 USB, AC Surge Protector Dock

ITEM NO.
PMXP360

\$44⁹⁵

**Phone not included*



- Convenient and innovative
- 6 outlets, 2 USB ports
- Direct plug-in wall mount
- USB charging cradle
- Rest 2 phones or 1 tablet
- 1650 joules / 15 Amps
- Protects electronic equipment

- Circle of protection LED
- Protect or Disconnect™ circuitry
- SmartGuard voltage monitoring
- \$75,000 protection policy
- Lifetime product warranty
- 5.9" x 1.4" x 4.7" / 1 lb

MOD-UTP5e Signal Line Protection Module

ITEM NO.
PMXMOD-UTP5e

\$49⁹⁵



- 1 pair LAN ports
- RJ-45 connectors
- Add-on expansion module
- Network computer protection
- High speed CAT5e compatible

- Up to 8 wires protected
- EMI/RFI noise filtration
- UL and cUL approved
- Lifetime product warranty
- 5" x 3.5" x 2" / 1 lb

PMXMOD-AT2 (Analog phone systems) **\$49.95**
PMXMOD-CAT5 (High-speed hard wired) **\$59.95**

MD2-TL AC Surge Protector

ITEM NO.
PMXMD2-TL

\$64⁹⁵



- 2 outlets, 1 Telco/LAN
- Direct plug-in wall mount
- 1350 joules / 1800 Watts
- Versatile outlet orientation
- Electronics, phone or LAN line
- Protect or Disconnect™ circuitry

- EMI/RFI noise filtration
- Removable, paintable cover
- Two diagnostic LED lights
- \$100,000 protection policy
- Lifetime product warranty
- 3" x 1.6" x 5.3" / 11 oz

PMXMD2 (AC only) **\$54.95**

SP8-AV Coax, Tel, A/V Surge Protector

ITEM NO.
PMXSP8-AV

\$89⁹⁵



- 8 outlets, 1 Tel, 1 coax
- Transformer spacing, 8' cord
- 1125 joules / 1800 Watts
- Protects cable, satellite, phone
- Designed for HD audio/video
- Protect or Disconnect™ circuitry

- EMI/RFI noise filtration
- UL and cUL approved
- \$50,000 protection policy
- Lifetime product warranty
- 5" x 12" x 1.8" / 3.5 lbs

M2A20 High Current AC Surge Protector

ITEM NO.
PMXM2A20

\$114⁹⁵



- 2 outlets, versatile angles
- Direct plug-in wall mount
- 1350 joules / up to 2400 Watts
- Three diagnostic LED lights
- Protects electronic equipment
- Protect or Disconnect™ circuitry

- EMI/RFI noise filtration
- Catastrophic surge circuit
- \$100,000 protection policy
- Lifetime product warranty
- 3" x 2" x 5.5" / 12 oz

M4LT-EX Premium Telco/LAN Surge Protector

ITEM NO.
PMXM4LT-EX

\$109⁹⁵



- 4 outlets, 1 Telco, 1 LAN
- Transformer spacing, 8' cord
- 1650 joules / 1800 Watts
- Office equipment protection
- RJ-45 is CAT5e compatible
- Protect or Disconnect™ circuitry

- EMI/RFI noise filtration
- Automatic voltage monitoring
- Accepts add-on modules
- \$5,000,000 protection policy
- Lifetime product warranty
- 4.8" x 8" x 2" / 2.4 lbs

PMXM4-EX (AC only) **\$69.95**

PM8-AV PowerMax Telco/Coax Surge Protector

ITEM NO.
PMXPM8-AV

\$105⁹⁵



- 8 outlets, 1 Telco, 2 coax
- Transformer spacing, 6' cord
- 1125 joules / 1800 Watts
- Protects cable, satellite, phone
- Designed for HD audio/video
- Protect or Disconnect™ circuitry

- EMI/RFI noise filtration
- Accepts add-on modules
- \$100,000 protection policy
- Lifetime product warranty
- 5" x 12" x 1.8" / 3.5 lbs

PMXPM8-EX (AC only) **\$69.95**
PMXM8-AV (Premium, AC/Coax) **\$149.95**
PMXM8-EX (Premium, AC only) **\$79.95**

MIP-15LT Max ImagePro Surge Protector

ITEM NO.
PMXMIP-15LT

\$219⁹⁵



- 2 outlets, 1 Telco, 1 LAN
- 8' cord, padlock & DSL splitter
- 1650 joules / 15 Amps
- AC, phone, network protection
- RJ-45 is CAT5e compatible
- Protect or Disconnect™ circuitry

- GFCI compatible EMI/RFI filter
- Automatic voltage monitoring
- Wiring fault safety shutoff
- \$5,000,000 protection policy
- Lifetime product warranty
- 4.8" x 10" x 2.5" / 4.5 lbs

PMXMIP-20LT (High current) **\$239.95**

Call Your Sales Representative Today

CSC36AC AC Charging Station Cart w/Zone Charging

ITEM NO.
TRPCSC36AC

\$1,926⁰⁰



- Charge, Sync, secure AC devices
- Up to 36 devices at one time
- Timer alternates charging zones
- In-cabinet RJ45 jack
- Dual external AC Outlets

- Laminated wood grain-top
- Black locking steel cabinet
- Ships fully assembled

- 2 year limited warranty
- 42.3" x 28" x 26.04" / 111 lbs

CSC16USB USB Charging Station

ITEM NO.
TRPCSC16USB

\$1,382⁴⁰



- Charge, Sync, secure USB devices
- Up to 16 tablets at one time
- Such as iPad, Android, Kindle
- Sync devices w/host computer
- Delivers up to 2.4 amps / port
- Removable tablet dividers

- Flow-through ventilation
- Black locking steel cabinet
- Mount to wall, table or floor
- 30.3" x 21.6" x 18.8" / 85 lbs

TRPCSC32USB (32 USB tablets)..... **\$2,646.00**

CSC16AC AC Charging Station

ITEM NO.
TRPCSC16AC

\$1,159²⁰



- Charge, Sync, secure AC devices
- Up to 16 laptops at one time
- Fits laptops up to 17" screen
- Sync devices w/host computer
- Removable device dividers
- Flow-through ventilation
- Black locking steel cabinet

- Wall, desk, floor mountable
- Ships fully assembled
- 2 year limited warranty
- 30.3" x 21.6" x 18.8" / 85 lbs

TRPCSC32ACW (32 AC Laptops, white)..... **\$1,911.60**
TRPCSC32AC (32 AC Laptops) **\$1,936.80**

M100-10N-BK USB Sync/Charge Cable

ITEM NO.
TRPM10010NBK

\$18⁸⁰



- Allows data loading to & from iPhone, iPad, iPod devices
- Charging device at same time
- Reversible lightning connector
- USB computer or wall adapter

- Fits iPhone 5, 5c, 5s, 6, 6 Plus
- iPad 4th, mini 2 & 3, Air, Air 2
- iPod Touch 5th, nano 7th Gen

- MFI Certified cable, 10" long
- 2 year limited warranty

SUPER7 *Protect It!™ Surge Suppressor*

ITEM NO.
TRPSUPER7

\$32⁸⁰



- Protects everything with a plug against surges and spikes!
- 7 outlets, 7' cord
- Right angle plug
- 2160 joules

- EMI/RFI noise filtering
- RoHS and UL approved
- \$75,000 insurance policy
- Lifetime product warranty

Item No.	Outlets	Joules	Cord	List
TRPTLP602	6	180	2'	\$13.30
TRPTLP606	6	790	6'	21.20
TRPTLP606USB	6+2USB	990	6'	36.00
TRTLP608	6	990	8'	26.40
TRPSUPER6TEL	7+RJ11	1080	6'	35.60
TRPTLP74RB	7	1080	4'+RA	24.40
TRPSTRIKER	7	1080	6'+RA	31.60
TRPTLP725	7	1080	25'	62.40

IBAR4 *Isobar® Surge Suppressor*

ITEM NO.
TRPIB4

\$88⁸⁰



- Protection for everything w/ a plug
- 4 outlets, 6' cord
- 3330 joules
- Unique isolated filter banks
- Rugged all-metal housing

- EMI/RFI noise filtering
- UL and cUL approved
- \$50,000 insurance policy
- Lifetime product warranty

Item No.	Outlets	Joules	Cord	List
TRPIB20	2	1410	Direct	\$48.00
TRPIB6U	6	3330	6'	111.20
TRPIB8U	8	3840	12'	123.20

INTERNET350U *Desktop UPS System*

ITEM NO.
TRPI350U

\$94⁵⁰



- Protects PCs & peripherals
- 6 outlets + tel/DSL, 6' cord
- 350 VA / 180 Watts
- 11 min. half-load runtime
- EMI/RFI noise filtering

- Status LEDs & audible alarms
- USB interface
- Free PowerAlert software
- \$100,000 insurance policy
- 3 year product warranty

Item No.	Outlets	VA	1/2 Load Runtime	List
TRPI550U	8+RJ11	550	10 min.	\$115.20
TRPI750U	12+RJ11	750	11 min.	160.20
TRPI900U	12+RJ11	900	10 min.	180.00

TLP810NET *Protect It!™ Surge Suppressor*

ITEM NO.
TRPTLP810N

\$80⁰⁰



- Protects everything with a plug against surges and spikes!
- 8 outlets + RJ45, RJ11, Coax
- 10' cord w/right angle plug
- 3240 joules

- Status LED; audible alarms
- EMI/RFI noise filtering
- RoHS and UL approved
- \$250,000 insurance policy
- Lifetime product warranty

Item No.	Outlets	Joules	Cord	List
TRPTLP808	8	1440	8'+RA plug	\$42.40
TRPTLP808T	8+RJ11	2160	8'+RA plug	53.60
TRPTLP1208IT	8+RJ11+Coax	2160	8'+RA plug	72.00

BC350 *Standby UPS System*

ITEM NO.
TRPBC350

\$87³⁰



- Protects PC home theater
- 6 outlets, 6' cord
- 350VA / 210 Watts
- 7 min. half-load runtime
- User replaceable batteries

- EMI/RFI noise filtering
- Desktop or wall mountable
- \$100,000 insurance policy
- 3 year product warranty

Item No.	Outlets	VA	1/2 Load Runtime	List
TRPBC450	3	450	15 min.	\$96.30
TRPBC800U	12	450	8.6 min.	\$156.60

AVR550U *AVR UPS System*

ITEM NO.
TRPAVR550U

\$126⁹⁰



- Protects PCs, workstations, small servers & more
- 8 outlets + tel/DSL, 6' cord
- 550 VA / 300 Watts
- 10 min. half-load runtime
- Automatic voltage regulation

- EMI/RFI noise suppression
- Status LEDs & audible alarms
- USB interface
- Free PowerAlert software
- \$100,000 insurance policy
- 3 year product warranty

Item No.	Outlets	VA	1/2 Load Runtime	List
TRPAVR750U	12+RJ11	750	10 min.	\$172.80
TRPAVR900U	12+RJ11	900	10 min.	180.00
TRPOVS800	7+RJ45	800	11.5 min.	264.60
TRPOVS1000	8+RJ45	1000	14 min.	266.40
TRPOVS1500XL	8+RJ45	1500	13+ min.	453.60

Call Your Sales Representative Today

ECO550U Energy-Saving UPS System

ITEM NO.
TRPECO550U

\$133²⁰



- Protects PC and peripherals
- Save up to \$50/yr energy costs
- 99% power efficiency
- Tel/DSL line protection
- 8 outlets (3 ECO), 6' cord
- 550 VA / 300 Watts

- 10 min. half-load runtime
- EMI/RFI noise filtering
- USB interface
- Free PowerAlert software
- \$100,000 insurance policy
- 3 year product warranty

Item No.	Outlets	VA	1/2 Load Runtime	List
TRPECO350U	6+RJ11	350	11 min.	\$102.60
TRPECO750U	12+RJ11	750	11.5 min.	178.20

ECO850LCD Energy-Saving UPS System with LCD Screen

ITEM NO.
TRPECO850LCD

\$178²⁰



- Protects PC and peripherals
- Save up to \$50/yr energy costs
- 99% power efficiency
- Tel/DSL line protection
- 12 outlets (4 ECO), 6' cord
- 850 VA / 425 Watts

- 13 min. half-load runtime
- Interactive LCD display panel
- Enhanced USB monitoring port
- Free PowerAlert software
- \$100,000 insurance policy
- 3 year product warranty

Item No.	Outlets	Comm.	1/2 Load Runtime	List
TRPECO650LCD	8+RJ11	USB	10 min.	\$147.60

SMART1000LCD Digital AVR UPS System

ITEM NO.
TRPSMART1000LCD

\$266⁴⁰



- Protects PCs, small servers & A/V equipment
- 8 outlets + Tel/DSL/Coax
- 1000 VA / 500 Watts
- 10 min. half-load runtime
- Automatic voltage regulation

- EMI/RFI noise filtering
- Rotatable LCD status display
- USB interface
- Free PowerAlert software
- \$250,000 insurance policy
- 3 year product warranty

Item No.	Outlets	VA	1/2 Load Runtime	List
TRPOMNI650LCD	8	650	12 min.	\$217.80
TRPOMNI900LCD	8	900	10 min.	243.00
TRPSMART1300LCDT	8+RJ11, RJ45, Coax	1300	10 min.	288.00
TRPSMART1500LCDT	8+RJ11, RJ45, Coax	1500	10 min.	356.40

SMART500RT1U SmartPro Rackmount UPS System

ITEM NO.
TRPSMART500RT1U

\$352⁸⁰



- Protects servers, network and telecom systems
- 7 outlets, 10' cord
- 500 VA / 300 Watts
- 15 min. half-load runtime
- Advanced AVR
- EMI/RFI noise filtering

- Status LEDs & audible alarms
- USB, Serial, EPO interfaces
- Free PowerAlert software
- \$250,000 insurance policy
- 2 year warranty, 3 yr warranty w/registration

Item No.	Outlets	VA	1/2 Load Runtime	List
TRPSMART1000RM2U	6	1000	15 min.	\$912.60
TRPSMART1500RM2U	8	1500	13 min.	1,139.40

SMART750 Tower AVR UPS System

ITEM NO.
TRPSMART750

\$461⁰⁰



- Protects servers & telecom equipment
- 6 outlets, 6' cord
- 750 VA / 450 Watts
- 16 min. half-load runtime
- User replaceable batteries
- Advanced AVR
- EMI/RFI noise filtering

- Status LEDs & audible alarms
- USB interface
- Free PowerAlert software
- \$250,000 insurance policy
- 2 year warranty, 3 yr warranty w/registration

Item No.	Outlets	VA	1/2 Load Runtime	List
TRPSMART1500	6	1500	20 min.	\$876.60
TRPSMART2200VS	9	2200	19 min.	1,404.00

PS2408 Vertical Power Strip

ITEM NO.
TRPPS2408

\$82⁴⁰



- Power a variety of electronics w/multiple convenient outlets
- 8 standard NEMA 5-15R outlets
- 2.48" center-to-center spacing
- 24" all-metal housing, 15' cord
- Horizontal or vertical mounting

- Lighted, covered on/off switch
- 15 amp circuit breaker
- UL and cUL approved
- Lifetime limited warranty

Item No.	Outlets	Length	Spacing	List
TRPPS3612	12	36"	2.64"	\$93.60
TRPPS4816	16	48"	2.72"	111.20
TRPPS6020	20	60"	2.80"	124.80

P10 *Electric Pencil Sharpener*

ITEM NO.
ADLP10

\$19⁹⁹



- Classic look, excellent value
- Vertical top insertion
- Automatic start and stop
- Helical steel cutting blade

- Transparent shavings bin
- Non-skid rubber feet
- 1 year limited warranty

P80 *Electric Pencil Sharpener*

ITEM NO.
ADLP80

\$39⁹⁹



- Stylish desktop design
- Heavy-duty school quality
- Adjustable pencil opening
- 4 diameters to choose from
- Automatic start and stop
- Helical steel blades

- Sharpened point indicator
- Built-in 6 pencil holder
- Extra large receptacle
- 13 year limited warranty

ELECTRONICS/OFFICE ACCESSORIES

DCX610 *Compact Standing Desk*

ITEM NO.
VCTDCX610

\$294⁹³



- Adjustable sit or stand desk
- Ideal for various height users
- Sits on top of current desk
- No attachment required
- Easy squeeze right side lever
- Smooth gas spring adjustment
- 32.5" x 18" desk surface

- 32.5" x 13" removable tray
- Max height 15" tray/19" desk
- Sleek black wood construction
- Durable laminate coating
- Monitor hole and steel base
- 3 year limited warranty
- 32.5" x 18" x 19" / 34 lbs

DCX710G *Standing Desk Converter*

ITEM NO.
VCTDCX710G

\$507²⁹



- Adjustable sit or stand desk
- Ergonomic for varied heights
- Sits on top of current desk
- No clamp attachment required
- Easy-to-use height adjustment
- Smooth gas spring system
- Monitor mount through-hole

- 31" x 23" desk surface
- 30" x 14" keyboard tray
- 20" desk / 15.5" tray max height
- Wood with laminate coating
- Heavy no tipping steel base
- 3 year limited warranty
- 31" x 21" x 23" / 47 lbs

DCX760G *Standing Workstation*

ITEM NO.
VCTDCX760G

\$530⁸⁹



- Adjustable sit or stand desk
- Sits on top of existing desk
- Fixed dual platform design
- Expansive 36" x 23" work surface
- Adjustable 35" x 14" keyboard tray

- 20" desk / 15.5" tray max height
- Grommet mount for monitor
- Two slots for accessory storage
- 12 ergonomic height positions
- Single lever gas cylinder system

- Stylish modern gray design
- Protective laminate coating
- Heavy duty black steel base
- 3 year limited warranty
- 37" x 21" x 23" / 59 lbs

Call Your Sales Representative Today

MD-16GC452 USB 2.0 Slide Flash Drive

ITEM NO.
EMCMD16GC452

\$550



- Reliable portable data storage
- Exclusive capless EMTEC design
- Convenient slide to open system
- 16GB capacity, USB 2.0
- Up to 15 MB/s read, 5 MB/s write
- Store, carry and transfer files

- Simple plug-and-play detection
- Windows / Mac / Linux
- Keychain or lanyard hole
- Matte black finish
- 2.7" x 0.8" x 0.4"

EMCMD32GC452 (32 GB).....	6.20
EMCMD64GC452 (64 GB).....	\$8.20

SU-KPBL8 SecureUSB KP Flash Drive

ITEM NO.
EMCSUKPBL8

\$8900



- Hardware encrypted USB flash drive
- 8GB, USB 3.0, AES256-bit XTS
- Will work with any operating system
- USB 2.0/3.0/3.1 device compatible
- IP57 certified dust & water resistant
- Interior parts covered in Epoxy
- Special coat, wear resistant keypad

- Keypad user authentication
- Admin, user & read-only modes
- Preloaded DriveSecurity antivirus
- Brute force anti-hack self destruct
- Built-in Lithium-Ion Polymer battery
- Inactivity autolock, FIPS validated
- 3 year limited warranty
- 3" x 0.8" x 0.4" / 0.49 oz

EMCSUKPBL32 (32 GB).....	\$149.00
EMCSUKPBL64 (64 GB).....	\$179.00

SD-KPBL500GB SecureDrive KP External Portable drive

ITEM NO.
EMCSDKPBL500GB

\$23900



- 12.5mm thin encrypted hard drive
- 1TB HDD, USB 3.0, AES256-bit XTS
- Will work with any operating system
- USB 2.0/3.0/3.1 device compatible
- Unmatched design and ease-of-use
- Wear, misuse resistant keypad

- Keypad user authentication
- Admin, user & read-only modes
- Preloaded DriveSecurity antivirus
- Brute force anti-hack data erase
- Inactivity autolock, FIPS validated
- 2 year limited warranty
- 5" x 3" x 0.5"

EMCSDKPBL1TB (1TB)	\$275.00
EMCSDKPBL2TB (2TB)	\$329.00
EMCSDKPBL4TB (4TB)	\$419.00
EMCSDKPBL5TB (5TB)	\$549.00
EMCSDBTBU1TB (Bluetooth)	\$285.00
EMCSDBTBU2TB (Bluetooth)	\$339.00
EMCSDBTBU4TB (Bluetooth)	\$429.00
EMCSDBTBU5TB (Bluetooth)	\$559.00

MD-32GB253 USB 3.0 Slide Flash Drive

ITEM NO.
EMCMD32GB253

\$720



- Dependable portable data storage
- Exclusive capless EMTEC design
- Convenient slide to open system
- 32GB capacity, USB 3.0
- Up to 20 MB/s read, 10 MB/s write
- Universal USB2/3 compatibility

- Save, move, quick file transfer
- Windows / Mac / Linux
- Keychain or lanyard hole
- Matte gray finish
- 2.6" x 0.78" x 0.4"

EMCMD64GB253 (64 GB).....	\$10.50
EMCMD128GB253 (128 GB).....	\$19.00
EMCMD256GB253 (256 GB).....	\$32.00

SU-BTBU16 SecureUSB BT Flash Drive

ITEM NO.
EMCSUBTBU16

\$11900



- Hardware encrypted USB flash drive
- 16GB, USB 3.0, AES256-bit XTS
- Will work with any operating system
- USB 2.0/3.0/3.1 device compatible
- IP57 certified dust & water resistant
- Crush resistant body protects USB
- Unlock using Touch ID or FaceID

- Bluetooth user authentication
- Admin, user & read-only modes
- Remote wipe with unique command
- Preloaded DriveSecurity antivirus
- Brute force anti-hack self destruct
- Ten foot Step-away autolock
- 3 year limited warranty
- 2.24" x 0.8" x 0.4" / 0.42 oz

EMCSUBTBU32 (32 GB).....	\$159.00
EMCSUBTBU64 (64 GB).....	\$189.00

SD-BTBU250GBSSD SecureDrive BT External Portable Drive

ITEM NO.
EMCSDBTBU250SSD

\$31900



- Slim Bluetooth solid-state drive
- 250GB SSD, USB 3.0, FIPS compliant
- Will work with any operating system
- USB 2.0/3.0/3.1 device compatible
- 14 round process of data encryption
- DataLock app user authentication
- Unlock using PIN, Touch ID, FaceID

- Admin, user & read-only modes
- Remote wipe, password recovery
- Internal parts covered in Epoxy
- Preloaded ESET USB antivirus
- 10 attempt brute force anti-hack
- Inactivity and ten-step autolock
- 2 year limited warranty
- 5" x 3" x 0.5" / 5.8 oz

EMCSDBTBU500GBSSD (500GB)	\$395.00
EMCSDBTBU1TBSSD (1TB)	\$559.00
EMCSDBTBU2TBSSD (2TB)	\$969.00
EMCSDBTBU4TBSSD (4TB)	\$1,879.00
EMCSDBTBU8TBSSD (8TB)	\$3,639.00
EMCSDKPBL250GBSSD (Keypad)	\$309.00
EMCSDKPBL500GBSSD (Keypad)	\$385.00
EMCSDKPBL1TBSSD (Keypad)	\$549.00
EMCSDKPBL2TBSSD (Keypad)	\$959.00
EMCSDKPBL4TBSSD (Keypad)	\$1,869.00
EMCSDKPBL8TBSSD (Keypad)	\$3,629.00

Performance with a Lifetime Guarantee



We understand you need supplies you can trust. Your customers can trust. That's why we stand behind NXT Premium with a LIFETIME GUARANTEE.

Superior Quality. Increased Profitability. Guaranteed.

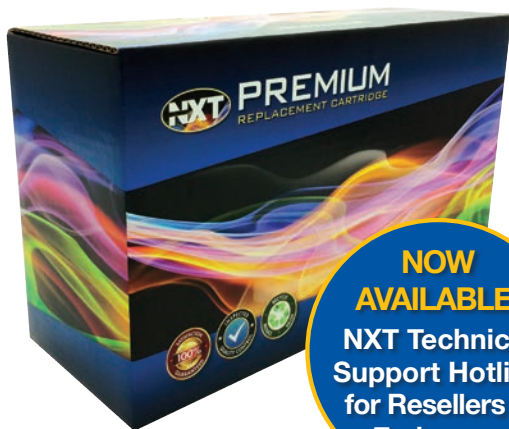

NOW AVAILABLE!
NXT Technical Support Hotline for Resellers & End-users

NXT Premium is the NeXT Best Thing in Toner

Others keep telling you that buying and selling their recycled toner is to your advantage, but NXT Premium Replacement Cartridges are quality-tested, performance certified cartridges that offer a Lifetime Warranty.

- 100% lifetime warranty
- Certified performance (ISO/STMC)
- Reduce printing costs up to 50%
- High quality new components
- Expanded U.S. distribution

www.NXTpremium.com

CLAX CART *Innovative Folding Cart*

ITEM NO.
QQCCLAX

\$349⁰⁰

- Easy-to-use lightweight design
- One button folds-up in seconds
- For home or work applications
- High quality solid construction
- Safe, stable, durable mobility

- Flexible functionality
- 44lb & 88lb shelf capacities
- Carry heavy equipment
- Use as dolly for bulk/tall items
- Collapse & store in closet/car



- Includes free folding crate
- 21.5" x 28" x 40.5" / 14.8 lbs

solo

PORTFOLIO

UBN101 *Everyday Ace Slim Laptop Brief*

ITEM NO.
USLUBN101-4

\$51⁹⁹



- Padded area holds 15.6" laptop
- Front zippered organizer area
- Dedicated iPad/tablet pocket
- Thumb-contoured zipper pulls
- Padded carrying handles

- Adjustable shoulder strap
- Rear Ride Along® strap
- Black Polyester exterior
- 5 year limited warranty
- 15.5" x 2" x 11.25" / 1.2 lbs

STM223 *Surge iPad/Tablet Case & Stand*

ITEM NO.
USLSTM223-4

\$61⁹⁹



- One case for countless brands
- Ideal for tablet, iPad, eReader
- Universal fit adjusts 8.5" to 11"
- Tension clips for secure hold
- Portrait or landscape viewing
- Swivel mounted back design

- Secure magnetic clasp
- Black Polyester exterior
- 5 year limited warranty
- 8" x 1.5" x 10.5" / 7 oz

ACV711 *Ascend Launch Laptop Backpack*

ITEM NO.
USLACV711-4

\$74⁹⁹



- Padded 17.3" laptop protection
- Internal iPad/tablet pocket
- Hard-shell zip-down organizer
- Front & side zippered pockets
- Headphone port

- Padded carrying handle
- Padded shoulder straps
- Polyester body
- 5 year limited warranty
- 14.5" x 7" x 19.5" / 2.1 lbs

CLA314 *Empire Laptop Briefcase*

ITEM NO.
USLCLA314-4

\$96⁹⁹



- Pass thru airport security faster
- Laptop protection up to 17.3"
- Quick access & file pockets
- Front zip-down organizer area
- Front zippered pockets
- Adjustable shoulder strap

- Padded carrying handles
- Rear Ride Along® strap
- Black Ballistic Polyester body
- 5 year limited warranty
- 17.5" x 5.25" x 13.25" / 3 lbs

ACV700 *Ascend Rival Laptop Backpack*

ITEM NO.
USLACV700-4

\$109⁹⁹



- Padded 17.3" laptop protection
- Dedicated iPad/tablet pocket
- Front zip-down organizer area
- Front & side zippered pockets
- Cushioned carrying handle
- Padded shoulder straps

- Water resistant bottom
- Reflective strip for visibility
- Black Polyester body
- 5 year limited warranty
- 15.75" x 6.5" x 18.5" / 2.8 lbs

CLA901 *Dakota Rolling Overnighter*

ITEM NO.
USLCLA901-4

\$140⁹⁹



- Velcro, padded 16" laptop area
- Quick access front zip pocket
- Disk, glasses, camera pockets
- File folder and binder sections
- Clothing area w/strap & buckle
- Push-button telescopic handle

- Cushioned carrying handle
- Black Ballistic Polyester body
- 5 year limited warranty
- 16.25" x 8.75" x 14.25" / 7 lbs

LVL330 *Midtown Chrysler Laptop Briefcase*

ITEM NO.
USLLVL330-4

\$61⁹⁹



- Padded pocket holds 17.3" laptop
- Front zip-down organizer area
- Divided file compartment
- Remove/adjust shoulder strap
- Rear Ride Along® strap
- Black Polyester body
- 5 year limited warranty
- 17.25" x 12.5" x 4.25" / 2.05 lbs

K709 *Midtown Plaza Tote*

ITEM NO.
USLK709-4

\$70⁹⁹



- Stylish, professional look
- Padded pocket holds 16" laptop
- Red lining w/interior organizer
- Zippered top, exterior pocket
- Metal feet protect bottom of bag
- Adjustable shoulder straps
- Textured vinyl body
- Black with silver buckles
- 5 year limited warranty
- 18.5" x 4" x 13.75" / 2.5 lbs

K85 *Midtown Grand Central Attache`*

ITEM NO.
USLK85-4

\$80⁹⁹



- 4" deep vinyl body briefcase
- Expands 1" to increase storage
- Looks and feels like leather
- File pocket with Velcro closure
- Large main compartment
- Dual combination locks
- Locking hinges, sturdy handle
- Black with pewter accents
- 5 year limited warranty
- 17.5" x 12.5" x 4.25" / 4.4 lbs

B100 *Midtown Carnegie Rolling Case*

ITEM NO.
USLB100-4

\$122⁹⁹



- Protects laptops up to 15.6"
- Front zip-down organizer area
- Disk and accessory pockets
- Full length file section
- Telescoping handle system
- Cushioned carrying handles
- Extra-wide wheels for stability
- Black Ballistic Polyester body
- 5 year limited warranty
- 16" x 5.75" x 12.75" / 6 lbs

SGB300 *Midtown Paramount Retractable Strap Brief*

ITEM NO.
USLSGB300-4

\$130⁹⁹



- Padded pocket holds 16" laptop
- Interior organizer, file pocket
- Auto-retract Smart Strap® strap
- Front zip-down organizer area
- Padded frame construction
- Cushioned carrying handles
- Rear Ride Along® strap
- Black Polyester body
- 5 year limited warranty
- 18.25" x 6" x 12.75" / 5.5 lbs

B151 *Midtown Morgan Rolling Case*

ITEM NO.
USLB151-4

\$170⁹⁹



- CheckFast™ padded laptop sleeve
- Holds up to 17.3" laptop
- Hanging file system
- Telescopic handle system
- Sturdy, secure carrying handle
- Speed buckle closure
- Smooth rolling wheels
- Black Polyester body
- 5 year limited warranty
- 13.5" x 18" x 8" / 9.3 lbs

PV78 *Midtown Herald Rolling Catalog Case*

ITEM NO.
USLPV78-4

\$178⁹⁹



- Padded pocket holds 16" laptop
- Zip-down front compartment
- Fan file & organizer pockets
- Telescopic handle system
- Sturdy, secure carrying handle
- Dual combination locks
- Smooth rolling wheels
- Black Polyester body
- 5 year limited warranty
- 18" x 8.25" x 13.75" / 9.5 lbs

EXE950 *Executive Gramercy Park Rolling Case*

ITEM NO.
USLEXE950-10

\$240⁹⁹



- Laptop protection up to 15.6"
- Internal iPad/tablet pocket
- Organizer section w/key clip
- Front zippered pocket
- Four spinner wheels
- Padded carry handles
- Telescoping handle system
- Black Polyester
- 5 year limited warranty
- 18" x 15.2" x 8"

Call Your Sales Representative Today



TOGETHER, WE CAN SAVE THE WORLD

with our new

RE:CYCLED COLLECTION

FABRIC MADE FROM
RECYCLED OCEAN BOUND BOTTLES



UBN105 RE:Focus Laptop Sleeve

ITEM NO.
USLUBN105-10

\$40⁹⁹



- City function, sleek design
- Fully padded laptop sleeve
- Protects laptops up to 15.6"
- Front zippered pocket
- Back slip pocket
- Recycled PET Polyester

- Heathered grey exterior
- Interior black camo lining
- 5 year limited warranty
- 11.5" x 16.25" x 1"

UBN127 RE:New Laptop Briefcase

ITEM NO.
USLUBN127-10

\$86⁹⁹



- Fully padded laptop protection
- Fits Mac/Ultrabooks 11" - 15.6"
- Front zippered pocket
- Inner organizer with key clip
- Snap close carry handle
- Remove/adjust shoulder strap

- Slide over luggage back strap
- Heathered grey PET material
- Interior black camo lining
- 5 year limited warranty
- 12" x 16.25" x 4.5" / 1.4 lbs

UBN762 RE:Utilize Backpack Briefcase

ITEM NO.
USLUBN762-10

\$89⁹⁹



- Brief transforms into backpack
- Fully padded mesh compartment
- Laptop protection up to 15.6"
- Quick access zippered pockets
- Large front organizer section
- Hideaway backpack straps

- Remove/adjust shoulder strap
- Top and side carry handles
- Slide over luggage back strap
- Heathered grey PET exterior
- 5 year limited warranty
- 17" x 12.5" x 5"

UBN760 RE:Claim Laptop Backpack

ITEM NO.
USLUBN760-10

\$110⁹⁹



- Walk around campus in style
- Padded 15.6" laptop protection
- Front zippered pocket
- Organizer section & key clip
- Two mesh side pockets
- Double loop umbrella holder
- Two shoulder straps & handle

- Slide over luggage back strap
- Durable recycled PET material
- Interior black camo lining
- 5 year limited warranty
- 12.25" x 6.75" x 16.5" / 1.5 lbs

UBN915 RE:Start Underseat Rolling Case

ITEM NO.
USLUBN915-10

\$195⁹⁹



- Fits under most airline seats
- Two front zipper pockets
- Padded 15.6" laptop pouch
- Inner organizer with key clip
- Snap together carry handle
- Push-button telescopic handle

- Heathered grey PET material
- Water resistant fabric coating
- Interior black camo lining
- Easy-glide wheels
- 5 year limited warranty
- 14" x 16" x 6" / 3.7 lbs

UBN914 RE:Treat Carry-On Rolling Case

ITEM NO.
USLUBN914-10

\$219⁹⁹



- Meets airline requirements
- Laptop protection up to 15.6"
- Two front zipper pockets
- Interior organizer w/key clip
- Secure suppression straps
- Top and side carrying handles
- Push-button telescopic handle

- Soft heathered grey exterior
- Water resistant protection
- Interior black camo lining
- Easy-glide wheels
- 5 year limited warranty
- 22" x 14" x 7" / 5.7 lbs



Item #	List	Item #	List
CIM3392	\$3.20	CIM5441	\$7.50
CIM3393	\$3.20	CIM5451 (6 pk)	\$29.70
CIM3842	\$3.50	CIM5461 (6 pk)	\$41.95
CIM4021	\$12.99	CIM5471 (6 pk)	\$23.95
CIM4031	\$12.99	CIM5481	\$4.95
CIM4411	\$5.50	CIM5491	\$6.99
CIM4522	\$4.50	CIM5531 (12 pk)	\$39.00
CIM4531	\$4.95	CIM5533 (12 pk)	\$39.00
CIM4532	\$4.95	CIM5552	\$3.99
CIM4533	\$4.95	CIM5602	\$4.50
CIM4542	\$3.99	CIM5721	\$3.99
CIM4592	\$3.99	CIM5722	\$4.25
CIM4653	\$3.99	CIM5772	\$3.20
CIM5001	\$9.99	CIMIR40	\$2.05
CIM5111	\$3.20	CIMIR40T	\$2.45
CIM5183	\$3.99	CIMIR90	\$8.99
CIM5401 (6 pk)	\$35.95	CIMIR93	\$4.50



Item #	List	Item #	List
CMR021020	\$8.95	CMR360001KR	\$13.95
CMR021031	\$8.95	CMR370002K	\$14.95
CMR021041	\$8.95	CMR370002P	\$14.95
CMR021052	\$13.95	CMR400650C1P	\$15.00
CMR021070	\$13.95	CMR400650C3PRG	\$20.00
CMR20246	\$8.95	CMR401000C3PRG	\$25.00
CMR20361	\$5.95	CMR401000N1K	\$7.95
CMR20484	\$9.99	CMR401000N1P	\$7.95
CMR21501	\$10.99	CMR402016N1P	\$20.00
CMR21507	\$10.99	CMR410003N1K	\$7.95
CMR25909	\$19.95	CMR410003N1P	\$7.95
CMR310001K	\$19.50	CMR430001N1P	\$7.95
CMR310001R	\$19.50	CMR440001N2BR	\$7.95
CMR310003KR	\$13.95	CMR450001C1P	\$7.95
CMR320001K	\$13.95	CMR450002N1K	\$10.00
CMR320006K	\$19.50	CMR60E005P	\$9.95
CMR320006R	\$19.50	CMRUCH101000	\$14.99
CMR350001P	\$19.95	CMRUCH101010	\$14.99



Item #	List	Item #	List
POR562	\$8.99	POR11512	\$24.99
POR2166	\$3.99	POR11561	\$14.99
POR11304 (2 pk)	\$9.99	POR101221	\$8.99
POR11409 (2 pk)	\$7.99	PORPR12	\$3.99
POR11411	\$11.99	PORPR40	\$3.99
POR11413	\$13.99	PORPR42	\$4.99
POR11424	\$8.99	PORPR72	\$3.99
POR11438	\$8.99	PORPR74	\$4.99
POR11506	\$10.99	PORPR78BR	\$4.99
POR11507	\$9.99	PORPR78P	\$5.99
POR11470	\$6.99		



Ink Rollers

Item #	List	Item #	List
GRCR812P	\$4.50	GRCR872B	\$4.50
GRCR840B	\$4.50	GRCR874B	\$4.75
GRCR842BR	\$4.50	GRCR878BR	\$5.95

Calculator, POS & ATM Ribbons

Item #	List	Item #	List
GRCCR31BR (6 pk)	\$27.50	GRCE248BR	\$5.95
GRCE200BR	\$3.50	GRCE248P	\$5.95
GRCE201B	\$3.50	GRCE281P	\$4.50
GRCE201BR	\$3.50	GRCE282P	\$4.50
GRCE201P	\$3.50	GRCE285P	\$10.50
GRCE245P	\$9.50	GRCE287B	\$5.95
GRCE248B	\$5.95	GRCE289P	\$7.50

Typewriter Ribbons & Tapes

Item #	List	Item #	List
GRCT2B	\$8.00	GRCT325	\$5.50
GRCT2BR	\$8.00	GRCT326	\$5.50
GRCT4BW	\$12.95	GRCT328	\$6.25
GRCT5B	\$6.25	GRCT330	\$4.95
GRCT5BR	\$6.25	GRCT333	\$4.25
GRCT6B	\$6.25	GRCT340	\$6.95
GRCT6BR	\$6.25	GRCT350	\$4.95
GRCT28	\$10.11	GRCT355 (6 pk)	\$11.00
GRCT301	\$5.50	GRCT356 (6 pk)	\$17.70
GRCT306	\$4.95	GRCT366 (6 pk)	\$13.20
GRCT308	\$7.95	GRCT369	\$4.95
GRCT309	\$6.95	GRCT376 (6 pk)	\$10.80
GRCT311	\$8.95	GRCT381	\$5.50
GRCT315	\$6.25	GRCT385	\$17.85
GRCT316	\$5.50	GRCT387	\$5.95
GRCT321	\$4.95	GRCT394	\$14.50

Printer Ribbons

Item #	List	Item #	List
GRC8480	\$17.19	GRCT456 (6 pk)	\$161.70
GRCT407	\$9.75	GRCT480 (6 pk)	\$74.70
GRCT408	\$27.95	GRCT495	\$7.50
GRCT426	\$17.95	GRCT502	\$19.95
GRCT426S	\$17.95	GRCT506S	\$16.50
GRCT435	\$9.95	GRCT511	\$7.25
GRCT437	\$7.95	GRCT513	\$27.95
GRCT441	\$10.25	GRCT526	\$10.95
GRCT443	\$11.25	GRCT531	\$10.95
GRCT451	\$6.95	GRCT575	\$12.45
GRCT452	\$25.95		

TYPEWRITER, PRINTER, CALC, ETC.

MANUFACTURER	ITEM NO.	DESCRIPTION	LIST
ADLER-ROYAL, ROYAL			
-CALCULATORS			
10,40,50,101,110 SERIES,12PD/X/XP/XP, 121XP/XP, 8210PD, 8212PD			
GENERAL...	GRCR872B	IR72 INK ROLL BLK	4.50
12P,120P/PD,121P/PD,126P,300P/PD 1011PD,1012PD,1123			
MONROE...	MNEP51S	NYLON RIBBON BLK/RED	15.00
90PD,107PD,315PD,550HD,700PD,920PD,6600HD, 6800HD, CMS25,ER-125, EZVUE 550HD,6800HD			
CI INKS.....	CIMIR40	INK ROLL BLK	2.05
GENERAL...	GRCR840B	INK ROLL BLK	4.50
550HD			
GENERAL...	GRCR812P	CP12 INK ROLL PUR	4.50
224PD,226PD,228PD,770HD,910PD,912PD,930PD,42 12,PD, 6800PD,7600HD,7800HD,8112PD,9300,9500, EZVUE 7800,HD			
CI INKS.....	CIMIR40T	CP13 INK ROLL BLK/RED	2.45
GENERAL...	GRCR842BR	INK ROLL BLK/RED	4.50
1020PD, 1121PD, 1123PD, 1200PD, 1228PD, 1235PD, 1428PD, 8600HD			
MONROE...	MNEP65M	UNIVERSAL RIBBON BLK/RED	4.00
GENERAL...	GRCE201BR	FABRIC RIBBON BLK/RED	3.50
1122PD,1124PD			
MONROE...	MNEP71M	NYLON RIBBON BLK/RED	13.00
8150,8160,8250			
PORELON ..	POR101221	IR93 INK ROLL PURPLE	8.99

-CASH REGISTERS

CI INKS.....	CIMIR40	INK ROLL BLK	2.05
GENERAL...	GRCR840B	INK ROLL BLK	4.50
460NX, 462NX, 480NT/NX, 482NT/NX, 487NX, CL4000 CMS480/NT/NX/+, 481, 482/+, 486, 487/+, CMS7000			
GENERAL...	GRCE201P	UNIVERSAL RIBBON PURPLE	3.50
8150 & 8160 NT/NX, CMS8150NX, 8160NX, 8200, 8250			
PORELON ..	POR101221	IR93 INK ROLL PURPLE	8.99
ALPHA 580,587CX			
CI INKS.....	CIM5722	ERC-09 RIBBON PUR	4.25
GENERAL...	GRCE281P	ERC-09 NYLON RIBBON PUR	4.50
PORELON ..	POR11304	(2) ERC-09 Ribbon PUR	9.99
ALPHA 1750, 9170, CMS750, 9000, 9200			
GENERAL...	GRCE248B	NYLON RIBBON BLK	5.95
ALPHA 9150			
CI INKS.....	CIM3842	NYLON RIBBON PUR	3.50
CMS9160			
CI INKS.....	CIM4653	NYLON RIBBON BLK/RED	3.99
GENERAL...	GRCE287BR	NYLON RIBBON BLK/RED	5.95
ER185, 470CR			
CI INKS.....	CIMIR90	IR90 INK ROLL PURPLE	8.99

-TYPEWRITERS

310, 315, 320, 325, 390, 410, 415, 420, 425, ALPHA 610, 620C, BETA, 8100, 9000D, SAT. III, IIV, V, VI, VIII, OM 2000			
GENERAL...	GRCT326C	CORRECTABLE RIBBON BLK	5.50
GENERAL...	GRCT355	LIFT OFF TAPE(6PK)	11.00
1005/10/11/20/30/35/40/41/50, 5005/10/11/20/30/35/40/41			
GENERAL...	GRCT355	LIFT OFF TAPE(6PK)	11.00

MANUFACTURER	ITEM NO.	DESCRIPTION	LIST
--------------	----------	-------------	------

ADLER-ROYAL, ROYAL (cont.)

ALPHA 600/P, BETA800T, SATELLITE 40, 80, SIGNET 10, 20, 25, 45/T, 70, 100, TQ720, 820, 920,			
GENERAL...	GRCT325C	CORRECTABLE RIBBON BLK	5.50
NAKAJIMA.	NAKXC001	CORRECTABLE RIBBON BLK	5.99
OLIVETTI ..	OLI901250	CORRECTABLE RIBBON BLK	5.99
GENERAL...	GRCT355	LIFT OFF TAPE(6PK)	11.00
NAKAJIMA.	NAKL0001	LIFT OFF TAPE(6PK)	8.10
POWERWRITER, POWERWRITER MD			
OLIVETTI ..	OLI901285	CORRECTABLE RIBBON BLK	11.95
ROYAL.....	ROY900221	LIFT OFF TAPE (6PK)	8.75
RT7300, 7500, 7700			
GENERAL...	GRCT333C	CORRECTABLE RIBBON BLK	4.25
PORELON ..	POR11438	CORRECTABLE RIBBON BLK	8.99
GENERAL...	GRCT356	LIFT OFF TAPE(6PK)	17.70
SATELLITE II, 2001, 2002, 2015 ALPHA 2001			
NAKAJIMA.	NAKL0001	CORRECTABLE RIBBON BLK	6.99
GENERAL...	GRCT321C	CORRECTABLE RIBBON BLK	4.95
ROYAL.....	ROY901232	CORRECTABLE RIBBON BLK	11.99
NAKAJIMA.	NAKL0001	LIFT OFF TAPE(6PK)	8.10
ROYAL.....	ROY900221	LIFT OFF TAPE (6PK)	8.75
SE1000C/CD/CDL/E, SE2000/D, SE5000C/D, SE6000/D			
GENERAL...	GRCT387HYB	CORRECTABLE RIBBON BLK	5.95
TQ-620, TQ-840			
GENERAL...	GRCT301C	CORRECTABLE RIBBON BLK	5.50

APPLE -PRINTERS

IMAGEWRITER I, II, DMP-DOT MATRIX			
GENERAL...	GRCT437D	NYLON RIBBON BLK	7.95

AT&T -TYPEWRITERS

6100, 6110, 6200, 6210, 6300, 6310, 6610			
GENERAL...	GRCT301C	CORRECTABLE RIBBON BLK	5.50

BMC -CALCULATORS

12,120, MPD10S,12D,12S			
GENERAL...	GRCR872B	IR72 INK ROLL BLK	4.50
3012,3112,3612,3712,3800,3812			
GENERAL...	GRCT48W	BLK W/WHITE CORR-SPOOL	12.95
A100,AP80			
CI INKS.....	CIMIR40	INK ROLL BLK	2.05
GENERAL...	GRCR840B	INK ROLL BLK	4.50

-CASH REGISTERS

CR280			
CI INKS.....	CIM4531	NYLON RIBBON BLK	4.95
CI INKS.....	CIM4532	NYLON RIBBON PUR	4.95
CI INKS.....	CIM4533	NYLON RIBBON BLK/RED	4.95
CR760			
PORELON ..	POR101221	IR93 INK ROLL PURPLE	8.99



MANUFACTURER ITEM NO. DESCRIPTION LIST

BROTHER -TYPEWRITERS

AX, GX, SX, ZX SERIES, EM 30/ii, 31ii, 350/e,
ML 100, 300, 500, WP60, 65, 70, 75, 77S, 80, 85,
90, 95, 230B, 330MDS, 335B, 490, 620, 660/E, 680,
700D, 720, 760D, 800MDS, 900MDS, WP1000, 2000,
3000, 5000 SERIES

BROTHER ..BRT1030 CORRECTABLE RIBBON BLK 8.49
BROTHER ..BRT1032 NYLON RIBBON BLK 18.90
GENERAL...GRCT333C..... CORRECTABLE RIBBON BLK 4.25
GENERAL...GRCT335 LIFT OFF TAPE(6PK) 11.00
NAKAJIMA..NAKLO001..... LIFT OFF TAPE(6PK) 8.10



CE, CX, EXECUTRON, PROFESSIONAL SERIES,
CM1000, 2000, EM 60, 65, 80, 85, 100, 200, 250,
300, 401, 411, 430, 450, 530, 550, 630, 1050/DS,
HR10/C, 15/XL, 20, 25, 30, 35/P, 40, 100, WP1, 55,
200STM, 500, 510, 650

BROTHER ..BRT7020 CORRECTABLE RIBBON BLK 8.49
GENERAL...GRCT330C..... CORRECTABLE RIBBON BLK 4.95
GENERAL...GRCT355 LIFT OFF TAPE(6PK) 11.00
NAKAJIMA..NAKLO001..... LIFT OFF TAPE(6PK) 8.10
CM2050, EM 501, 511, 601, 605, 611, 701/
FX, 711, 721/FX, 750FX, 801, 811/FX, 850,
1000, 2000, 2050/D, PERFECTYPE SERIES



BURROUGHS

AP1317, 1318, C2000, 2050, 2056, 2155, 2156
CI INKS.....CIM5602..... NYLON RIBBON PUR 4.50
C6453, 6460, S600, 650, 690, 4000, 4100, 4600
MONROE...MNEP65M..... UNIVERSAL RIBBON BLK/RED 4.00



CANON -CALCULATORS

CP13, MP120DH/DL/DLE, P2DH, 15D, 22D/DX, 23DE/
DH, 32D, 120DH, 121DH, 170DH, 200DH/II/III, 220DH
CI INKS.....CIMIR40T..... CP13 INK ROLL BLK/RED 2.45
GENERAL...GRCR842BR..... INK ROLL BLK/RED 4.50
CP1000/03/08, 1010/13/18, 1025,
1200/01/02/03/04/08, 1210/12/13/14/16/18, 1220/23,
1230/31/33, 1240, 2000, 2010, 2030, CANOLA P1015,
1213, 1215, 1421, 1440,
MONROE...MNEP65M..... UNIVERSAL RIBBON BLK/RED 4.00
MP1, 10, P1, 8-10, 14, 20 SERIES, 24, 40, 41, 60-62,
70, 71



P100I

GENERAL...GRCR878BR..... EA781RB INK ROLL BLK/RED 5.95



TYPEWRITER, PRINTER, CALC, ETC.

MANUFACTURER ITEM NO. DESCRIPTION LIST

CANON (cont.)

MP 21-25, 31, 1210, 1211, 1216-1218, 1411, 1420
P1010/11, 1205, 1210/11/13, 1250/51, 1410/11,
1420/21, 1440/41

GENERAL...GRCT3166..... UNIVERSAL RIBBON BLK/RED 3.99
GENERAL...GRCT201B..... FABRIC RIBBON BLK 3.50
P1DH, 8DH, 10DH, 11DH, 21DX, 40DII/DII-2
CI INKS.....CIMIR40..... INK ROLL BLK 2.05
GENERAL...GRCR840B..... INK ROLL BLK 4.50
P12D, 26DII, 29D/II, 30D, 31/D, 34, 36DII, 39DII,
102D/II, 122D, 1018/DII, 1252D, 1253D/II
PORELO...PORPR72..... IR72 INK ROLL BLK 3.99



-TYPEWRITERS

AP100, 150, 1000, 15000, ES/MX/QS SERIES
FT3000, 5000, S55, 551/F, 58, 66, 661/F,
66MX, 68, 68S, 200, 300

GENERAL...GRCT316C..... CORRECTABLE RIBBON BLK 5.50
GENERAL...GRCT355 LIFT OFF TAPE(6PK) 11.00

AP105, 110, 155/II, 160/II, 200/300/400/500 SERIES,
600, 610, 700 6000 SERIES, VP1000, 3102, X SERIES

GENERAL...GRCT315C..... CORRECTABLE RIBBON BLK 6.25
GENERAL...GRCT355 LIFT OFF TAPE(6PK) 11.00

5415

NAKAJIMA..NAKHYC01..... HY CORR. RIBBON BLK 7.99
NAKAJIMA..NAKX001..... CORRECTABLE RIBBON BLK 5.99
NAKAJIMA..NAKLO001..... LIFT OFF TAPE(6PK) 8.10



AP740, 780, 800/8000 SERIES, VP6000, CUSTOM
SERIES

GENERAL...GRCT311C..... CORRECTABLE RIBBON BLK 8.95
GENERAL...GRCT355 LIFT OFF TAPE(6PK) 11.00

AP9017, 9417

NAKAJIMA..NAKEC800..... CORRECTABLE RIBBON BLK 9.99
NAKAJIMA..NAKLO001..... LIFT OFF TAPE(6PK) 8.10



CASIO

-CASH REGISTERS

101ER, 110CR, 115ER, 116ER, 120CR, 150CR,
160CR, 800ER, EC116ER, PCR202, 250, 255, 260,
265, 275

CI INKS.....CIMIR40..... INK ROLL BLK 2.05
GENERAL...GRCR840B..... INK ROLL BLK 4.50
103ER, 105ER, 108ER, 112ER, 114ER,
120ER, 180ER, 2150, 2250
GENERAL...GRCR872B..... IR72 INK ROLL BLK 4.50
3220, 6220, ER 1211,
MONROE...MNEP51S..... NYLON RIBBON BLK/RED 15.00



MP12, P1, P22D, 2002, 2004, 2008, 2010, 2030, 2050, 2060, 2080, 2100, 2120, 2140, 2160, 2180, 2200, 2220, 2240, 2260, 2280, 2300, 2320, 2340, 2360, 2380, 2400, 2420, 2440, 2460, 2480, 2500, 2520, 2540, 2560, 2580, 2600, 2620, 2640, 2660, 2680, 2700, 2720, 2740, 2760, 2780, 2800, 2820, 2840, 2860, 2880, 2900, 2920, 2940, 2960, 2980, 3000, 3020, 3040, 3060, 3080, 3100, 3120, 3140, 3160, 3180, 3200, 3220, 3240, 3260, 3280, 3300, 3320, 3340, 3360, 3380, 3400, 3420, 3440, 3460, 3480, 3500, 3520, 3540, 3560, 3580, 3600, 3620, 3640, 3660, 3680, 3700, 3720, 3740, 3760, 3780, 3800, 3820, 3840, 3860, 3880, 3900, 3920, 3940, 3960, 3980, 4000, 4020, 4040, 4060, 4080, 4100, 4120, 4140, 4160, 4180, 4200, 4220, 4240, 4260, 4280, 4300, 4320, 4340, 4360, 4380, 4400, 4420, 4440, 4460, 4480, 4500, 4520, 4540, 4560, 4580, 4600, 4620, 4640, 4660, 4680, 4700, 4720, 4740, 4760, 4780, 4800, 4820, 4840, 4860, 4880, 4900, 4920, 4940, 4960, 4980, 5000, 5020, 5040, 5060, 5080, 5100, 5120, 5140, 5160, 5180, 5200, 5220, 5240, 5260, 5280, 5300, 5320, 5340, 5360, 5380, 5400, 5420, 5440, 5460, 5480, 5500, 5520, 5540, 5560, 5580, 5600, 5620, 5640, 5660, 5680, 5700, 5720, 5740, 5760, 5780, 5800, 5820, 5840, 5860, 5880, 5900, 5920, 5940, 5960, 5980, 6000, 6020, 6040, 6060, 6080, 6100, 6120, 6140, 6160, 6180, 6200, 6220, 6240, 6260, 6280, 6300, 6320, 6340, 6360, 6380, 6400, 6420, 6440, 6460, 6480, 6500, 6520, 6540, 6560, 6580, 6600, 6620, 6640, 6660, 6680, 6700, 6720, 6740, 6760, 6780, 6800, 6820, 6840, 6860, 6880, 6900, 6920, 6940, 6960, 6980, 7000, 7020, 7040, 7060, 7080, 7100, 7120, 7140, 7160, 7180, 7200, 7220, 7240, 7260, 7280, 7300, 7320, 7340, 7360, 7380, 7400, 7420, 7440, 7460, 7480, 7500, 7520, 7540, 7560, 7580, 7600, 7620, 7640, 7660, 7680, 7700, 7720, 7740, 7760, 7780, 7800, 7820, 7840, 7860, 7880, 7900, 7920, 7940, 7960, 7980, 8000, 8020, 8040, 8060, 8080, 8100, 8120, 8140, 8160, 8180, 8200, 8220, 8240, 8260, 8280, 8300, 8320, 8340, 8360, 8380, 8400, 8420, 8440, 8460, 8480, 8500, 8520, 8540, 8560, 8580, 8600, 8620, 8640, 8660, 8680, 8700, 8720, 8740, 8760, 8780, 8800, 8820, 8840, 8860, 8880, 8900, 8920, 8940, 8960, 8980, 9000, 9020, 9040, 9060, 9080, 9100, 9120, 9140, 9160, 9180, 9200, 9220, 9240, 9260, 9280, 9300, 9320, 9340, 9360, 9380, 9400, 9420, 9440, 9460, 9480, 9500, 9520, 9540, 9560, 9580, 9600, 9620, 9640, 9660, 9680, 9700, 9720, 9740, 9760, 9780, 9800, 9820, 9840, 9860, 9880, 9900, 9920, 9940, 9960, 9980, 10000



CI INKS.....CIM5602..... NYLON RIBBON PUR 4.50
1215S, 2215

GENERAL...GRCR842BR..... INK ROLL BLK/RED 4.50
4100, 4200, CE-4105, 4110, 4115, 4500, 4515, 4530, 4530
4550, 4615, 4630, 4680, SA1000, 2000, SR2000,
TK300, 600, 1200, 2100, 2200, 2600, 3000, 4000/C,
4200, 4300, 4500, 4630

CI INKS.....CIM5552..... NYLON RIBBON PUR 3.99
3404, 3408, 3508, 3530, 4404, 4420, 4430, CE-2100,
2104, 2208, 3100, 3115, 3200, 3215, 3405, 3415,
3500/ER, 3535, 3630, 3640, 3680, 3700, 3750, 3815,
3830, SR6, TK100, 700, 710, 1000, 1100

CI INKS.....CIMIR90..... IR90 INK ROLL PURPLE 8.99

TYPEWRITER, PRINTER, CALC, ETC.

MANUFACTURER	ITEM NO.	DESCRIPTION	LIST
CASIO (cont.)			
	CE-2300, 2350, 2400, 7215		
PORELON ..	POR101221	IR93 INK ROLL PURPLE	8.99
	CE-2700, 4200, 4250, 4700, 6000, 7000, TK1300, 2300, 2700, 3100		
CI INKS.....	CIM4592	NYLON RIBBON PUR	3.99
	CE-4050, FE-2000, KP-300		
GENERAL...	GRCE248P	NYLON RIBBON PUR	5.95
	FE-700		
	GRCE281P	ERC-09 NYLON RIBBON PUR	4.50
	PCR-204, 208, 210, 330, 350, 355, 360, 450, 460		
	GRCE201P	UNIVERSAL RIBBON PURPLE	3.50



MANUFACTURER	ITEM NO.	DESCRIPTION	LIST
-CALCULATORS			
	DL200/210L, 220/A/L/LA, 250/270/300 SERIES, 280Z, 290, DR100/110/120 SERIES, 125, 210/220/250/270HD, 320A/B, 420, 1210/11/12/20, 1410, 1411, 1520/S, 3220, 6220P/R, 7210/20/50 8620, FR7250, R100-300, 1000, 1201/02/05		
MONROE ..	MNEP65M	UNIVERSAL RIBBON BLK/RED	4.00
GENERAL...	GRCE201BR	UNIVERSAL RIBBON BLK/RED	3.50
	FR90, 95, 101/C, 105S, 107, 121S, 122, 1015, 1215/S, 2550, HP100T, HR5, 7, 8 SERIES, 15, 16, 100TE, 121, 150L, 200		
CI INKS.....	CIMIR40	INK ROLL BLK	2.05
GENERAL...	GRCR840B	INK ROLL BLK	4.50
	FR120, 1010, 1210, 1211/S, 1500, 5100/L, 5200L, GR2100, 2150, 2200, 2250, 3250, 6250, HR120, 1105BK, JR SERIES		
GENERAL...	GRCR872B	IR72 INK ROLL BLK	4.50
	1215S, 2215, FR-50, 110/HT/S, 120C, 125/S, 127, 130, 520, 1110, 2215C/S, 2600, 2650/A/+, HR18, 21, 100LC/T/TE+/S, 120T, 150LA/LC/LC+/LCS/LS/TE+, 160L, 170L/LB,		
GENERAL...	GRCR842BR	INK ROLL BLK/RED	4.50



MANUFACTURER	ITEM NO.	DESCRIPTION	LIST
CITIZEN -PRINTERS			
	CBMDP600/CBM, DP700, DP600 SERIES, IDP-3530/40/50		
GENERAL...	GRCE248B	NYLON RIBBON BLK	5.95
	CI INK... CIM4653	NYLON RIBBON BLK/RED	3.99
	GSX130, 140/+, 220/C, 230, 240, 340, 540		
GENERAL...	GRCT511D	NYLON RIBBON BLK	7.25



MANUFACTURER	ITEM NO.	DESCRIPTION	LIST
CRS -CALCULATORS			
	720, 812, 820, 840, 900, 930, 960, 1200, 2200, 4200, 4300, 5200		
	GRCE201BR	UNIVERSAL RIBBON BLK/RED	3.50
MONROE ..	MNEP65M	UNIVERSAL RIBBON BLK/RED	4.00



MANUFACTURER	ITEM NO.	DESCRIPTION	LIST
-CASH REGISTERS			
	100, 120-122, 124, 200, 220, 250, 300, 720		
GENERAL...	GRCE201BR	UNIVERSAL RIBBON BLK/RED	3.50
MONROE ..	MNEP65M	UNIVERSAL RIBBON BLK/RED	4.00
	3720		
CI INKS.....	CIMIR90	IR90 INK ROLLER PUR	8.99



MANUFACTURER	ITEM NO.	DESCRIPTION	LIST
DECWRITER -PRINTERS			
	LA-50, 75, 75P, 75 PLUS		
GENERAL...	GRCT437D	NYLON RIBBON BLK	7.95
EPSON -PRINTERS			
ACTIONPRINTER 2250			
EPSON.....	EPSS015047	FABRIC RIBBON BLK	9.75
	AP3250		
EPSON.....	EPSS015032	FABRIC RIBBON BLK	9.95
	AP4500, 5500, L750, LQ1000, 1010, 1050/+, 1070/+, 1170		
EPSON.....	EPS7754	FABRIC RIBBON BLK	10.00
	CR510, 700, 750, 760		
PORELON ..	POR101221	IR93 INK ROLL PURPLE	8.99
	CR801, 802, 812, 900, 901, 910, 911		
CI INKS.....	CIMIR90	IR90 INK ROLL PURPLE	8.99
	DFX5000/+, 8000, 8500		
EPSON.....	EPS8766	FABRIC RIBBON BLK	33.00
	GRCE2820D	NYLON RIBBON BLK	29.50
	ERC-02ii; 210A/S, 211, CTM 210A, M210, 211, TM210, 215		
MONROE ..	MNEP51S	NYLON RIBBON BLK/RED	15.00
	ERC-03; 210V, 220, 240, M220, M240,		
CI INKS.....	CIM5602	NYLON RIBBON PUR	4.50
	ERC-04; AP2000, APT1000, FX70/+, 80/+, 85, 86E 800 SERIES, LX300/+, 400, 800 SERIES, MX/RX 70 SERIES, 80 SERIES		
EPSON.....	EPS8750	NYLON RIBBON BLK	6.00
	ERC-08; AP2500, FX100/+, 100+, 185, 286/E, 1000, 1050, 1150, 1170, 1180, MX/RX100 SERIES		
EPSON.....	EPS8755	FABRIC RIBBON BLK	9.00
	ERC-09, 80; M & NON M SERIES 160, 161, 163, 164, 180, 181, 182, 183, 185, 190, 192, 195, EHT-20, HX-20, 40, P-40		
CI INKS.....	CIM5722	ERC-09 RIBBON PUR	4.25
GENERAL...	GRCE281P	NYLON RIBBON PUR	4.50
PORELON ..	POR11304	(2) NYLON RIBBONS PUR	9.99
	ERC-18; 2630-2632, 2635-2637, 2640-2642, 2645-2647, 2660-2662, 2665-2667		
CI INKS.....	CIM5552	NYLON RIBBON PUR	3.99
GENERAL...	GRCE285P	NYLON RIBBON PUR	10.50
	ERC-19; AP3000, 4000, 5000/+, APL-1000, LQ200, 300/+, 400, 450, 500 SERIES, 800, 850/+, 870		
CI INKS.....	CIM5481	NYLON RIBBON BLK	4.95
EPSON.....	EPS7753	FABRIC RIBBON BLK	7.00
	ERC-23; M & NON M SERIES 250, 252, 255, 257, 260, 262, 264, 265, 267, 270, 280, 300, M119, RP-265, TM267, 270, 300		
CI INKS.....	CIM5183	NYLON RIBBON BLK/RED	3.99
GENERAL...	GRCE287BR	NYLON RIBBON BLK/RED	5.95
	ERC-27		
GENERAL...	GRCE289P	NYLON RIBBON PUR	7.50



TYPEWRITER, PRINTER, CALC, ETC.

MANUFACTURER ITEM NO. DESCRIPTION LIST

EPSON (cont.)

ERC-30, 34, 38; 270, 300, M133, 17, 270, 52,
TM-267, 270, 300, TM-U200, 210, 300, 325, 370, 375

CI INKS..... CIM4531..... NYLON RIBBON BLK..... 4.95
CI INKS..... CIM4532..... NYLON RIBBON PUR..... 4.95
CI INKS..... CIM4533..... NYLON RIBBON BLK/RED..... 4.95

ERC-31; 930, M26, 31, 32, 930, TM-925, 930, 950,
TM-H5000, TM-U590, U925, U950

CI INKS..... CIM4542..... NYLON RIBBON PUR..... 3.99

ERC-32; M & NON M 820, 825, TM-H6000, TM-U675,
U420

CI INKS..... CIM4592..... NYLON RIBBON PUR..... 3.99

ERC-37; 760, 780, 790

CI INKS..... CIM3842..... NYLON RIBBON PUR..... 3.50

FX2170, 2180 LQ2070, 2080, 2170, 2180

GENERAL... GRCT452D..... NYLON RIBBON BLK..... 25.95

EPSON..... EPSS015086..... FABRIC RIBBON BLK..... 27.00

LQ670, 680PRO, 860/+, 1060/+, 2500/+, 2550/+

EPSON..... EPS7762L..... NYLON RIBBON BLK..... 11.00

ERC SYS.

-CASH REGISTER

4140

CI INKS..... CIM5602..... NYLON RIBBON PUR..... 4.50

ESPER -PRINTERS

635, 730, 735, 750, 760, 855, 900, 7400,
7500/10/40, 7600, 7700, 7810, 8400, 9700/10/11/20,
A55, BR6000

CI INKS..... CIM5602..... NYLON RIBBON PUR..... 4.50

875 REMOTE

CI INKS..... CIM5183..... NYLON RIBBON BLK/RED..... 3.99

GENERAL... GRCE287BR..... NYLON RIBBON BLK/RED..... 5.95

-CASH REGISTER

7100, 7200

CI INKS..... CIMIR90..... IR90 INK ROLL PURPLE..... 8.99

FUJITSU -PRINTERS

DL3300, 3400/50, 3600, DPMG9, DX2100, 2200,
2300, 2400

GENERAL... GRCT531D..... NYLON RIBBON BLK..... 10.95

GILBARCO -PRINTERS

DOT-2 CART

MONROE... MNPE65M..... UNIVERSAL RIBBON BLK/RED..... 4.00

TCR6, 14, 15

CI INKS..... CIM5552..... NYLON RIBBON PUR..... 3.99

IBM/LEXMARK -PRINTERS

2380/2390 SERIES, FORMSPRINTER 2380/81+,
2390/91+

GENERAL... GRCT443D..... FABRIC RIBBON BLK..... 11.25

PORELON.. POR11506..... NYLON RIBBON BLK..... 10.99

MANUFACTURER ITEM NO. DESCRIPTION LIST

IBM/LEXMARK (cont.)

4227

LEXMARK.. LEX13L0034..... NYLON RIBBON BLK..... 74.40

4651, 4655, 4661

CI INKS..... CIM5183..... NYLON RIBBON BLK/RED..... 3.99

GENERAL... GRCE287BR..... NYLON RIBBON BLK/RED..... 5.95

-TYPEWRITERS

ACTIONWRITER, ACTIONWRITER I

GENERAL... GRCT326C..... CORRECTABLE RIBBON BLK..... 5.50

PORELON.. POR11424..... CORRECTABLE RIBBON BLK..... 8.99

GENERAL... GRCT355..... LIFT OFF TAPE(6PK)..... 11.00

SELECTRIC 71, 711, 713, 715

GENERAL... GRCT28C..... CORRECTABLE RIBBON BLK..... 10.11

SELECTRIC II, MEMORY 50, 60, 100

GENERAL... GRCT87HYB..... CORRECTABLE RIBBON BLK..... 5.95

PORELON.. POR11411..... CORRECTABLE RIBBON BLK..... 11.99

SELECTRIC III, 210

GENERAL... GRCT385C..... CORRECTABLE RIBBON BLK..... 17.85

WHEELWRITER MODELS, 3, 5, 6, 10, 20, 30, 40, 50,
70, 1000, 1500, 2000, 2500, 3000, 3500, 5000, 7000

GENERAL... GRCT340C..... CORRECTABLE RIBBON BLK..... 6.95

GENERAL... GRCT350..... LIFT OFF TAPE..... 4.95

MINOLTA

-TYPEWRITERS

EW401, 501

GENERAL... GRCT308C..... CORRECTABLE RIBBON BLK..... 7.95

GENERAL... GRCT376..... LIFT OFF TAPE(6PK)..... 10.80

MONROE

-CALCULATORS

12PD, 120PD, SB612, SB1212

CI INKS..... CIMIR40T..... CP13 INK ROLL BLK/RED..... 2.45

GENERAL... GRCT442BR..... INK ROLL BLK/RED..... 4.50

121PD, 5130, 5140, 7130, 7140, 7150, CLASSIC, PRO

MONROE... MNPE51S..... NYLON RIBBON BLK/RED..... 15.00

MONROE... MNPE65M..... UNIVERSAL RIBBON BLK/RED..... 4.00

1400, 2020 SERIES 122PD, SB2012, 5150, 6120

MONROE... MNPE65M..... UNIVERSAL RIBBON BLK/RED..... 4.00

2100, 2700, 2800, 3100, 4100 SERIES

MONROE... MNPE71M..... NYLON RIBBON BLK/RED..... 13.00

8125

MONROE... MNPE65M..... UNIVERSAL RIBBON BLK/RED..... 4.00

MONROE... MNPE81M..... NYLON RIBBON BLK/RED..... 16.25

NAKAJIMA

-TYPEWRITERS

AE300 SERIES

NAKAJIMA.. NAKEC001..... CORRECTABLE RIBBON BLK..... 6.99

NAKAJIMA.. NAKL0001..... LIFT OFF TAPE(6PK)..... 8.10

AE800 SERIES

NAKAJIMA.. NAKEC800..... CORRECTABLE RIBBON BLK..... 9.99

NAKAJIMA.. NAKL0001..... LIFT OFF TAPE(6PK)..... 8.10

AE500, 710, 740, WPT150, 160, AX76, AX90

NAKAJIMA.. NAKHYC01..... HY CORR. RIBBON BLK..... 7.99

NAKAJIMA.. NAKXC001..... CORRECTABLE RIBBON BLK..... 5.99

NAKAJIMA.. NAKL0001..... LIFT OFF TAPE(6PK)..... 8.10

TYPEWRITER, PRINTER, CALC, ETC.

MANUFACTURER	ITEM NO.	DESCRIPTION	LIST
NCR			
-PRINTERS			
	7455		
CI INKS.....	CIM4531	NYLON RIBBON BLK.....	4.95
	CIM4532	NYLON RIBBON PUR.....	4.95
CI INKS.....	CIM4533	NYLON RIBBON BLK/RED.....	4.95
	2061,5400		
CI INKS.....	CIM5602	NYLON RIBBON PUR.....	4.50
	2106, 2109		
CI INKS.....	CIMIR90	IR90 INK ROLL PURPLE.....	8.99
	2170 K SERIES, 2173		
CI INKS.....	CIM4592	NYLON RIBBON PUR.....	3.99
	2170 SERIES, 2190, 7161, 7445, 7454		
CI INKS.....	CIM5183	NYLON RIBBON BLK/RED.....	3.99
	7162, 7166, 7452, 7453		
CI INKS.....	CIM4542	NYLON RIBBON PUR.....	3.99
	MA-156		
CI INKS.....	CIMIR40	CP16 INK ROLL BLK.....	2.05
	MA-305, 315		
PORELON ..	POR101221	IR93 INK ROLL PURPLE.....	8.99



NEC			
-PRINTERS			
	8025, 8027 PC8000 SERIES, ASTRA 2080,		
GENERAL...	GRCT437D	NYLON RIBBON BLK.....	7.95
	PINWRITER P2200, 2200XE		
GENERAL...	GRCT435D	NYLON RIBBON BLK.....	9.95



OKIDATA			
-PRINTERS			
	MICROLINE ML172, 180, 182, 183, 184, 192/+,		
	193/+, 194, 195, 280, 320/TURBO, 321/TURBO,		
	OKIMATE 140		
CI INKS.....	CIM5111	NYLON RIBBON BLK.....	3.20
GENERAL...	GRCT407D	NYLON RIBBON BLK.....	9.95
	PRM10507	NYLON RIBBON BLK.....	9.99
PREMIUM..	PRM2058S	NYLON RIBBON BLK-BX/6.....	58.00
	OKI452102001	NYLON RIBBON BLK.....	14.00
	MICROLINE ML380, 390/+TURBO, 391/+TURBO,		
	OKIMATE 140		
CI INKS.....	CIM5111	NYLON RIBBON BLK.....	3.20
GENERAL...	GRCT407D	NYLON RIBBON BLK.....	9.75
	PRM10507	NYLON RIBBON BLK.....	9.99
OKIDATA ..	OKI52104001	NYLON RIBBON BLK.....	17.00
	MICROLINE ML393/C/+C+, 395/C, ET8550		
CI INKS.....	CIM4031	NYLON RIBBON BLK.....	12.99
GENERAL...	GRCT408D	NYLON RIBBON BLK.....	27.95
PREMIUM..	PRM835	NYLON RIBBON BLK.....	14.00
	PRM10512	NYLON RIBBON BLK.....	24.99
OKIDATA ..	OKI52103601	NYLON RIBBON BLK.....	46.50
	MICROLINE ML420, 421		
	OKI452377801	NYLON RIBBON BLK.....	19.00
	MICROLINE ML520, 521		
	OKI452107001	NYLON RIBBON BLK.....	24.00
GENERAL...	GRCT575D	NYLON RIBBON BLK.....	12.45
	MICROLINE ML590, 591		
	OKI452106001	NYLON RIBBON BLK.....	23.75
GENERAL...	GRCT575D	NYLON RIBBON BLK.....	12.45



MANUFACTURER	ITEM NO.	DESCRIPTION	LIST
OKIDATA (cont.)			
	PACEMARK 3410		
OKIDATA ..	OKI52105801 ..	NYLON RIBBON BLK.....	55.00
	PACEMARK 4410		
	OKI4520629302 ..	NYLON RIBBON BLK.....	54.15



OLIVETTI			
-CALCULATORS			
	162PD, 720PD, 900PD-920PD, EC121, 122, 162, IR72		
GENERAL...	GRCR872B	IR72 INK ROLL BLK.....	4.50
	700PD, ECR-001, 002, 100EV, 300EV, IR-40, LOGOS		
	91, 92		
CI INKS.....	CIMIR40	INK ROLL BLK.....	2.05
GENERAL...	GRCR840B	INK ROLL BLK.....	4.50
	PORELON ..PORPR40	INK ROLL BLK.....	3.99
	8700 SERIES 8730, 8740, 8750, 8760/II, 8770/II,		
	MOVIERE71M	NYLON RIBBON BLK/RED.....	13.00



-TYPEWRITERS			
	900X, 901D, CX880		
NAKAJIMA. NAKEC001	CORRECTABLE RIBBON BLK.....	6.99	
GENERAL...	GRCT321C	CORRECTABLE RIBBON BLK.....	4.95
NAKAJIMA. NAKLO001	LIFT OFF TAPE(6PK).....	8.10	
	CX440/M/S/PLUS, 450, 900, 1000/S		
NAKAJIMA. NAKXC001	CORRECTABLE RIBBON BLK.....	5.99	
NAKAJIMA. NAKLO001	LIFT OFF TAPE(6PK).....	8.10	
	ET65, 66, 550, ETC65, 66, ETP55, 56, 60, 65, 66,		
	510, 520, 540, 550, 1000, 1500, HD550		
	GRCT301C	CORRECTABLE RIBBON BLK.....	5.50
	ET101, 121, 125, 201, 202, 221, 225, 231, 251,		
	351, 401, 501, 545, 548, 621, 701, ETS1010, 1020,		
	ETV300, TES351, 401, 501, 601, 621, 701, 1000,		
	DY211, 311, 811		
	GRCT381C	CORRECTABLE RIBBON BLK.....	5.50
GENERAL...	GRCT376	LIFT OFF TAPE(6PK).....	10.80
OLIVETTI ..	OLI7289816 ..	LIFT OFF TAPE.....	2.05
	ET109-112, 115-119, 211, 240, 250, ETV240/+ , 250,		
	260, 500, 3000		
	OLI7890345 ..	CORRECTABLE RIBBON BLK.....	7.95
	OLI7289816 ..	LIFT OFF TAPE.....	2.05
GENERAL...	GRCT376	LIFT OFF TAPE(6PK).....	10.80
	LINEA 198		
OLIVETTI ..	OLI7331556 ..	FABRIC RIBBON BLK.....	2.45
	OLI7331656 ..	FABRIC RIBBON BLK/RED.....	2.81



OLYMPIA			
-CALCULATORS			
	CPD 3120, 3210/11, EC122, 162, 1500, 2000,		
	PD2012, 3211		
GENERAL...	GRCR872B	IR72 INK ROLL BLK.....	4.50
	Ca505, 525, CP-510,525,550,570,575,2410 CPD-		
	640,641, 2000,2001,2002, 2410,4512,5212,5312,531		
	4,5421,6401, 6410,7512,8512,8514, CPS10, EC5000		
	MONROE ..MNEP65M	UNIVERSAL RIBBON BLK/RED.....	4.00
	CA22, 120, CPD6201, 6210, 7220, EC3000, 4000,		
	4512, 6000, 7000, 7512, 8000, 8512, ORBIT CM,		
	PD10, 12		
MONROE ..	MNEP51S	NYLON RIBBON BLK/RED.....	15.00
	EC7010, CPD123		
GENERAL...	GRCR842BR	INK ROLL BLK/RED.....	4.50



Call Your Sales Representative Today

MANUFACTURER ITEM NO. DESCRIPTION LIST

OLYMPIA (cont.)

CASH REGISTERS

CM-720, 721/+, 725, 726/+, 880

CI INKS..... **CIMIR40**..... INK ROLL BLK 2.05

GENERAL... **GRCR840B**..... INK ROLL BLK 4.50

PORELON... **PORPR40**..... INK ROLL BLK 3.99

CM-730, 735, 888/K, 898/R, 899

PREMIUM... **AVB2172P**..... 5-FABRIC RIBBON PURPLE..... 15.75

CM-1712, 1736

PORELON... **POR101221**..... IR93 INK ROLL PURPLE..... 8.99

CM-1920, 1930, 1935, 1936, 2030, 2035, 2130, 2135

GENERAL... **GRCE248B**..... NYLON RIBBON BLK..... 5.95

S2100

GENERAL... **GRCE201P**..... UNIVERSAL RIBBON PURPLE 3.50

S2200

CI INKS..... **CIMIR90**..... IR90 INK ROLL PURPLE..... 8.99

S2800

CI INKS..... **CIM3842**..... NYLON RIBBON PUR 3.50

S3100, 3115

CI INKS..... **CIM5552**..... NYLON RIBBON PUR 3.99

GENERAL... **GRCE285P**..... NYLON RIBBON PUR 10.50

S3600, 3615 TAROS series, S4000

CI INKS..... **CIM4592**..... NYLON RIBBON PUR 3.99



No Picture available



-PRINTERS

NP-136-24

EPSON..... **EPS7754**..... FABRIC RIBBON BLK 10.00

-TYPEWRITERS

CARRERA I/I DE LUXE, CARRERA III, MONICA, MONICA 2, MONICA 2MD, PRESTIGE(MD), SPLENDID(MD),

GENERAL... **GRCT333C**..... CORRECTABLE RIBBON BLK 4.25

PORELON... **POR11438**..... CORRECTABLE RIBBON BLK 8.99

GENERAL... **GRCT356**..... LIFT OFF TAPE(6PK) 17.70

CARRERA IV, IV DELUXE

GENERAL... **GRCT330C**..... CORRECTABLE RIBBON BLK 4.95

NAKAJIMA... **NAKL0001**..... LIFT OFF TAPE(6PK) 8.10

CARRERA DELUXE(MD) XL-700,750, COMPACT 5/5DM, STARTYPE 2-3, MASTERTYPE 2-3, 20, XL120, 121, 122M, 125DM, 501, 505, 512, 5700, 5750,

NAKAJIMA... **NAKHYC01**..... HY CORR. RIBBON BLK 7.99

NAKAJIMA... **NAKXC001**..... CORRECTABLE RIBBON BLK..... 5.99

NAKAJIMA... **NAKL0001**..... LIFT OFF TAPE(6PK) 8.10

COMPACT II, REPORT ELECTRONIC, COMPACT 3

NAKAJIMA... **NAKEC001**..... CORRECTABLE RIBBON BLK 6.99

NAKAJIMA... **NAKL0001**..... LIFT OFF TAPE(6PK) 8.10

COMPACT I, S, ES90, 93/DM, 95/I, EXCELLENCE 230, MASTERTYPE D, 100i, 110i, 120i, ORBIT, ORBIT DM, PROFESSIONAL 220/I, STANDARD 200/I, 220i, STARTYPE 130i, 150i, SUPERTYPE 230/I, 240/I, 250/I

GENERAL... **GRCT328C**..... CORRECTABLE RIBBON BLK 6.25

NAKAJIMA... **NAKL0001**..... LIFT OFF TAPE(6PK) 8.10

ESW-1000/C, 2000/I/C, 2500/I, 3000/K

GENERAL... **GRCT328C**..... CORRECTABLE RIBBON BLK 6.25

NAKAJIMA... **NAKL0001**..... LIFT OFF TAPE(6PK) 8.10

PERSONAL WRITER

NAKAJIMA... **NAKHYC01**..... HY CORR. RIBBON BLK..... 7.99

NAKAJIMA... **NAKL0001**..... LIFT OFF TAPE(6PK) 8.10

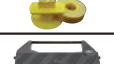
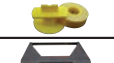

TYPEWRITER, PRINTER, CALC, ETC.

MANUFACTURER ITEM NO. DESCRIPTION LIST

OLYMPIA (cont.)

STANDARD 300, SUPERTYPE 330

NAKAJIMA... **NAKEC800**..... CORRECTABLE RIBBON BLK 8.10

TRAVELERC

OLIVETTI... **OLI7331525**..... NYLON RIBBON BLK/RED..... 5.50

XL SERIES

GENERAL... **GRCT325C**..... CORRECTABLE RIBBON BLK 5.50

NAKAJIMA... **NAKHYC01**..... HY CORR. RIBBON BLK..... 7.99

NAKAJIMA... **NAKXC001**..... CORRECTABLE RIBBON BLK..... 5.99

GENERAL... **GRCT355**..... LIFT OFF TAPE(6PK) 11.00

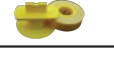

PANASONIC -PRINTERS

1801, 1804, 1805, 1810, 1820, JE-775, 820P, 1801P, 1804P, 1805P, 1820P, 2820P, 2821P, 2830P

GENERAL... **GRCR872B**..... IR72 INK ROLL BLK..... 4.50

5000, JS-500, 510, 5000

CI INKS..... **CIM4592**..... NYLON RIBBON PUR 3.99

JE-651P, 654NP, 656P, 659P, 661P, 765P

CI INKS..... **CIMIR40T**..... CP13 INK ROLL BLK/RED..... 2.45

JE-652P, 653P, 658NP, 660NP

CI INKS..... **CIMIR40**..... CP16 INK ROLL BLK..... 2.05

JS-130, 660, 800, 7000, RM-800, WS-800RM

GENERAL... **GRCE248B**..... NYLON RIBBON BLK..... 5.95

JS-460, 650, 4500, 4600, 4610, 6500, 6511, 6520

CI INKS..... **CIM5602**..... NYLON RIBBON PUR..... 4.50

JS-7500, 8000, 9000, MCDONALD POS

CI INKS..... **CIM5772**..... MICRONIS RIBBON PUR..... 3.20

PM300, 308

CI INKS..... **CIM4531**..... NYLON RIBBON BLK..... 4.95

CI INKS..... **CIM4532**..... NYLON RIBBON PUR..... 4.95

KX-P140, P155, P1524, P1540, P1624, P1654, P2624, P3624

PANASONIC... **PANKXP155**..... NYLON RIBBON BLK..... 22.90

KX-P145, 1123, 1124, 1124I, 1140, 2023

GENERAL... **GRCT526D**..... NYLON RIBBON BLK..... 10.95

PANASONIC... **PANKXP145**..... NYLON RIBBON BLK..... 15.50

KX-P1000, 1030, 1031, 1080-1083, 1090-1092, 1150, 1170, 1180/I, 1190, 1191, 1592, 1595, 1695, 2000, 2150

GENERAL... **GRCT526D**..... NYLON RIBBON BLK..... 10.95

KX-P2130, P2135

PANASONIC... **PANKXP160**..... NYLON RIBBON BLK..... 25.00

KX-P3200

PANASONIC... **PANKXP180**..... FABRIC RIBBON BLK 31.25



-TYPEWRITERS

KX-R SERIES, KX-W SERIES

GENERAL... **GRCT333C**..... CORRECTABLE RIBBON BLK 4.25

GENERAL... **GRCT376**..... LIFT OFF TAPE(6PK) 10.80

KX-E3000, 3008, 3100, 7000/i/CB1-4, 7500/S, 8000

GENERAL... **GRCT340C**..... CORRECTABLE RIBBON BLK 6.95

GENERAL... **GRCT376**..... LIFT OFF TAPE(6PK) 10.80



TYPEWRITER, PRINTER, CALC, ETC.

MANUFACTURER	ITEM NO.	DESCRIPTION	LIST
PANASONIC (cont.)			
		KX-E400-700/4000 SERIES, 2000/20, 2500, JETWRITER I, II	
GENERAL.....	GRCT381C.....	CORRECTABLE RIBBON BLK.....	5.50
GENERAL.....	GRCT376.....	LIFT OFF TAPE.....	10.80



MANUFACTURER	ITEM NO.	DESCRIPTION	LIST
RADIO SHACK -PRINTERS			
		EC3011,3012	
CI INKS.....	CIMIR40.....	INK ROLL BLK.....	2.05
GENERAL.....	GRCR840B.....	INK ROLL BLK.....	4.50
PORELON.....	PORPR40.....	INK ROLL BLK.....	3.99



MANUFACTURER	ITEM NO.	DESCRIPTION	LIST
SAMSUNG -CASH REGISTERS			
		CR-812A, ER-1710A, 1805, 1810, 2610, 2615, 2710, 2715, 3715, 3740, 4100, 4715	
CI INKS.....	CIMIR90.....	IR90 INK ROLL PURPLE.....	8.99
		ER100, 150	
CI INKS.....	CIMIR40.....	CP16 INK ROLL BLK.....	2.05
GENERAL.....	GRCE201P.....	UNIVERSAL RIBBON PURPLE.....	3.50
		ER350, 550, 700, ERP200, SMP200, SRP100, 200, 250	
CI INKS.....	CIM5772.....	SP300 RIBBON PUR.....	3.20
		ER415, 4640/P, 4800, 4900, 4915, 4940, 5100, 5140, 6500, 6540, 8000, EPR300/V, 400, SER5200, 6500, 6540	
CI INKS.....	CIM5552.....	ERC-18 RIBBON PUR.....	3.99



MANUFACTURER	ITEM NO.	DESCRIPTION	LIST
SANYO -CALCULATORS			
		CX5322, CY5322, SERD 1212	
GENERAL.....	GRCR842BR.....	CP13 INK ROLL BLK/RED.....	4.50
		CX2053/54, 2500, 3412, CY320, 500, 2000/15, 2152/2155, 2161/62, 2200/02, 2250, 3200, 5000, 5100, 6100, 6200	
MONROE.....	MNEP65M.....	UNIVERSAL RIBBON BLK/RED.....	4.00



MANUFACTURER	ITEM NO.	DESCRIPTION	LIST
-CASH REGISTERS			
		360/65/70, 460/70, 500/05/10/15, 550/60/70, ECR305, 325, 335/38, 355, 360/65, 375, 380, 450-470, 500/05, 515, 520, 550-570, 600, 4400, 4810, 4818, 5400, 5800, 6020, LX500	
CI INKS.....	CIMIR90.....	IR90 INK ROLL PURPLE.....	8.99
		ECR100, 120, 71A, 211PD, 1212PD, CX3551	
GENERAL.....	GRCR872B.....	IR72 INK ROLL BLK.....	4.50
		ECR105, 115, 138, 290, CX3553, 5510, 5512, LX3553	
CI INKS.....	CIMIR40.....	INK ROLL BLK.....	2.05
GENERAL.....	GRCR840B.....	INK ROLL BLK.....	4.50
PORELON.....	PORPR40.....	INK ROLL BLK.....	3.99
		ECR340, 358, 548	
GENERAL.....	GRCE248B.....	IR61B RIBBON BLK.....	5.95
		ECR525, 545, 580, 635, 645, 650, 690, 691, 692, 700, 710, 720, LX 700, 710, 720, SMP 301, 302/A, 501	
CI INKS.....	CIM5602.....	NYLON RIBBON PUR.....	4.50
		ECR640, 641,6400, 6410, 835	
CI INKS.....	CIM5552.....	NYLON RIBBON PUR.....	3.99



MANUFACTURER	ITEM NO.	DESCRIPTION	LIST
SASI -PRINTERS			
		POS SYSTEM W, EPSON TM930	
CI INKS.....	CIM4542.....	NYLON RIBBON PUR.....	3.99

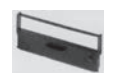

MANUFACTURER	ITEM NO.	DESCRIPTION	LIST
SEIKO -PRINTERS			
		210/S/V, 220, 240, M220	
CI INKS.....	CIM5602.....	ERC-03 RIBBON PUR.....	4.50
		310, 350, 355, 360, 370, 600	
MONROE.....	MNEP51S.....	NYLON RIBBON BLK/RED.....	15.00
		CR812, 900,901, 910	
CI INKS.....	CIMIR90.....	IR90 INK ROLL PURPLE.....	8.99



MANUFACTURER	ITEM NO.	DESCRIPTION	LIST
SHARP -CALCULATORS			
		1157, 2156, 2159, 2166, 2181, 2186, 2054, 2062, 2063, 2137, 2187, 2406, 2606, 2608, 2610, 2690, 4690, BE41PR, CS1152DH, 1181, 1191, 1194, 2194, 4194, 2850, 2870, EL1630/A/G, 2615/G, 2630, QS1660, 1760/A, 2660, 2770, 2760/A, 2770/A, VX1172, 1174, 1184, 1652/A/B, 2652/A/B	
MONROE.....	MNEP65M.....	UNIVERSAL RIBBON BLK/RED.....	4.00
		CS1198, 2189, EL1021, 1071, 1166, 1168, 1169, 1182, 1189, 1510, 1871, 2158, 2168/A, 2169, 2269, QS2110, 2122A, 2169, VX1189, 1199, 2173, 2183, 2185, 2189, 2650	
GENERAL.....	GRCR872B.....	IR72 INK ROLL BLK.....	4.50
		EL1192B/D/H/S, 1601 SERIES	
		1615, 1625H, 1628, 180L, 2617	
CI INKS.....	CIMIR40.....	INK ROLL BLK.....	2.05
GENERAL.....	GRCR840B.....	INK ROLL BLK.....	4.50
PORELON.....	PORPR40.....	INK ROLL BLK.....	3.99
		EL1192C/BL/G, 1801C/E, 2801E, 2901C/E, 2192C/G/GII/P/R	
GENERAL.....	GRCR878BR.....	EA780BR INK ROLL BLK/RED.....	5.95
		EL1197/III/IV/G SERIES, 2197/II/III/G SERIES, QS2168	
PORELON.....	PORPR74.....	EA741R INK ROLL PUR.....	4.99
		EL1609, 1610, 1611 SERIES, 1619, 1621, 1701C, 1801A/II	
GENERAL.....	GRCR812P.....	CP12 INK ROLL PUR.....	4.50
		EL1614, 1620/S, 1626/H, 2192, 2620/S, 2626/H, 2628, VX1614	
GENERAL.....	GRCR842BR.....	CP13 INK ROLL BLK/RED.....	4.50



MANUFACTURER	ITEM NO.	DESCRIPTION	LIST
-TYPEWRITERS			
		PA3000 & 3100 SERIES, 4000, 4300, PA-W1100, 1400, 1410	
GENERAL.....	GRCT306C.....	CORRECTABLE RIBBON BLK.....	4.95
GENERAL.....	GRCT356.....	LIFT OFF TAPE(6PK).....	17.70
		PA3300, 3320, 3300, XQ & ZX SERIES, ZY1000/S	
GENERAL.....	GRCT308C.....	CORRECTABLE RIBBON BLK.....	7.95
GENERAL.....	GRCT376.....	LIFT OFF TAPE(6PK).....	10.80



MANUFACTURER	ITEM NO.	DESCRIPTION	LIST
-CASH REGISTERS			
		BE-2500-2530, 2580, 3230/31, 3240/41, 4200, 6500/10, ER33SP, 37SP, 42SP, 2580/S, 2980, 3230/31, 3240/41, 4200/30/50, 4300/20, FCR-4230, PC1211, 1500	
CI INKS.....	CIM5602.....	NYLON RIBBON PUR.....	4.50
		ER1875, 1920, 1921S, 2370/80/81/85, 2386/S, 2390/91, 2395/96, 2540/41, 2590/S, 2592/95, 2905/08/10, 3010, 3536, 3600, 3630, 3660, ERA330, XE2055,	
CI INKS.....	CIMIR90.....	IR90 INK ROLL PURPLE.....	8.99
		ER-2640, 3100/10/15, 3250, 3300/10/11, 4100/10	
CI INKS.....	CIM5552.....	NYLON RIBBON PUR.....	3.99
		ER-2975, 3210	
CI INKS.....	CIM4531.....	NYLON RIBBON BLK.....	4.95
CI INKS.....	CIM4532.....	NYLON RIBBON PUR.....	4.95
CI INKS.....	CIM4533.....	NYLON RIBBON BLK/RED.....	4.95
		ER-3120, 3550, ER-A510/S, A550/S, A570, A610A, A650	
CI INKS.....	CIM4592.....	NYLON RIBBON PUR.....	3.99



MANUFACTURER ITEM NO. DESCRIPTION LIST

SHARP (cont.)

ER-A430, A770, ER-03	
GENERAL... GRCE248B... NYLON RIBBON BLK.....	5.95
XEA101, 110, 115, 120, 130	
CI INKS... CIMIR40... INK ROLL BLK.....	2.05
GENERAL... GRCR840B... INK ROLL BLK.....	4.50
PORELON... PORPR40... INK ROLL BLK.....	3.99

SILVER REED -TYPEWRITERS

8510, 8550, 8610, 8650, 8700, 8750, SR12, 100, 150, 180, 200, 250, 280, 500, 2600, SILVERETE	
GENERAL... GRCT4BW... NYLON RIBBON BLK/WHT.....	12.95
EX50-70, 200-400 SERIES, EXW2000, EZ40, 43, 45, 46, 50	
GENERAL... GRCT381C... CORRECTABLE RIBBON BLK.....	5.50
EXP200-800 SERIES	
GENERAL... GRCT381C... CORRECTABLE RIBBON BLK.....	5.50
10PD, 101PD, 121PD, 123PD, 1231PD, 1250PD, 1520PD, 1720PD	
GENERAL... GRCR872B... IR72 INK ROLL BLK/RED.....	4.50

SMITH CORONA -TYPEWRITERS

C SERIES	
SMC... SMC17657... NYLON RIBBON BLK.....	19.00
H SERIES	
GENERAL... GRCT309C... CORRECTABLE RIBBON BLK.....	6.95
SMC... SMC21000 (2 PK) . CORRECTABLE RIBBON BLK.....	13.50
SMC... SMC67108 (6 PK) . CORRECTABLE RIBBON BLK.....	28.25
SMC... SMC21025... MULTISTRIKE RIBBON BLK.....	18.20
SMC... SMC59048... LIFT OFF TAPE.....	8.50
SMC... SMC21060... LIFT OFF CASSETTE.....	7.50
GENERAL... GRCT369... LIFT OFF CASSETTE.....	4.95
STANDARD & ELECTRIC	
GENERAL... GRCT2B... NYLON RIBBON BLK.....	8.00
GENERAL... GRCT4BW... NYLON RIBBON BLK/WHT.....	12.95
WORDSMITH 100, 200 K SERIES	
SMC... SMC22200... CORRECTABLE RIBBON BLK.....	14.50
SMC... SMC22210... LIFT OFF TAPE(2PK).....	9.50

STAR MICRONICS -PRINTERS

MP200 212, 216, 221, 231, 232, 235, 236, 242, 246, 292, SP200, 212, 216, 242, 246, 298, 2000, 2320, 2520, 2560	
CI INKS... CIM3392... NYLON RIBBON PUR.....	3.20
MP300, 312F, 317, 321-323, 342, 347, 352S, 382, SCP700, SP300, 311/12, 316/17, 320-323, 341/42, 347-349, UP389	
CI INKS... CIM5772... MICRONIS RIBBON PUR.....	3.20

SWINTEC -TYPEWRITERS

1146CM, 1186CM, 4000, 4040, 8000, 8011, 8012, 8014, 8016, 8017, 9500	
NAKAJIMA . NAKEC001... CORRECTABLE RIBBON BLK.....	6.99
NAKAJIMA . NAKL0001... LIFT OFF TAPE(6PK).....	8.10

TYPEWRITER, PRINTER, CALC, ETC.

MANUFACTURER ITEM NO. DESCRIPTION LIST

SWINTEC (cont.)

600/40, 1000, 2000, 2400/16, 2500, 2600/40, 3200, 3500	
NAKAJIMA . NAKHYC01... CORRECTABLE RIBBON BLK.....	7.99
NAKAJIMA . NAKL0001... LIFT OFF TAPE(6PK).....	8.10
7000/S, 7001, 7003, 7040	
NAKAJIMA . NAKEC800... CORRECTABLE RIBBON BLK.....	9.99
NAKAJIMA . NAKL0001... LIFT OFF TAPE(6PK).....	8.10

-CALCULATORS

110/PD, 111, 112P/PD, 211, 212PD, 400DP, 401DP, 512D, 514DP	
MONROE... MNEP65M... UNIVERSAL RIBBON BLK/RED.....	4.00
301 DP	
GENERAL... GRCR842BR... CP13 INK ROLL BLK/RED.....	4.50
SW20	
CI INKS... CIMIR40... INK ROLL BLK.....	2.05
GENERAL... GRCR840B... INK ROLL BLK.....	4.50
PORELON... PORPR40... INK ROLL BLK.....	3.99
SW1260	
CI INKS... CIM5722... ERC-09 RIBBON PUR.....	4.25
GENERAL... GRCE281P... NYLON RIBBON PUR.....	4.50
SW2140	
PORELON... POR101221... IR93 INK ROLL PURPLE.....	8.99

TEC

-CASH REGISTERS

FDS300, RKP300, ST5500	
CI INKS... CIM5772... MICRONIS RIBBON PUR.....	3.20
MA55, MA156	
CI INKS... CIMIR40... CP16 INK ROLL BLK.....	2.05
MA305/R, MA315	
PORELON... POR101221... IR93 INK ROLL PURPLE.....	8.99
MA1300	
GENERAL... GRCE248B... NYLON RIBBON BLK.....	5.95
MA1350	
CI INKS... CIM4592... NYLON RIBBON PUR.....	3.99
MA1450, 1650, FS1450, 1530, 1535, 1650 SLIP PRINTERS	
GENERAL... GRCE289P... NYLON RIBBON PUR.....	7.50
RE-2000, 2500, 3000, 3500	
CI INKS... CIM4531... NYLON RIBBON BLK.....	4.95
CI INKS... CIM4532... NYLON RIBBON PUR.....	4.95
CI INKS... CIM4533... NYLON RIBBON BLK/RED.....	4.95

TEXAS INSTRUMENTS -CALCULATORS

5015, 5024, 5027/II, 5029/II/A, 5030/II, 5032SV, 5033/II, 5034/SV	
CI INKS... CIMIR40... INK ROLL BLK.....	2.05
GENERAL... GRCR840B... INK ROLL BLK.....	4.50
PORELON... PORPR40... INK ROLL BLK.....	3.99
5032SVC, 5035/II, 5045/II/IIA/SV, 5345II	
GENERAL... GRCR842BR... CP13 INK ROLL BLK/RED.....	4.50
5142, 5150, 5630, 8230, 8630	
GENERAL... GRCR872B... IR72 INK ROLL BLK.....	4.50
5160, 5219, 5221, 5315, 5317, 5320/II/SV, 5330, 5340, 5640-5660, 8250, 8260, 8660	
MONROE... MNEP65M... UNIVERSAL RIBBON BLK/RED.....	4.00
5200, 5215, 5217, 5219	
MONROE... MNEP51S... NYLON RIBBON BLK/RED.....	15.00

-PRINTERS

TL & OMNI 810/LQ, 880/AT/DP, 885/AT, TL-815, TL-817	
GENERAL... GRCT495D... NYLON RIBBON BLK.....	7.50
TL & OMNI 8920, 8930	
GENERAL... GRCT502D... NYLON RIBBON BLK.....	19.95

TYPEWRITER, PRINTER, CALC, ETC.

MANUFACTURER	ITEM NO.	DESCRIPTION	LIST
UNIWELL			
-CASH REGISTERS			
		1000, 1315, 2000, SYSTEM 15, 30, MODEL 10, UN-1000, 1310, 1315, 2000, 2300, 2315	
CI INKS.....	CIM5602.....	NYLON RIBBON PUR.....	4.50
		TP-420, TP-422, TP-522, TP-722	
CI INKS.....	CIM5183.....	NYLON RIBBON BLK/RED.....	3.99
GENERAL.....	GRCE287BR.....	NYLON RIBBON BLK/RED.....	5.95
VICTOR.....	VCT7011.....	NYLON RIBBON BLK/RED.....	5.10
		U100, 118, 128	
GENERAL.....	GRCR840B.....	CP16 INK ROLL BLK.....	4.50
CI INKS.....	CIMIR40.....	CP16 INK ROLL BLK.....	2.05
		UX-40	
CI INKS.....	CIM3842.....	NYLON RIBBON PUR.....	3.50
VERIFONE			
-POS TERMINALS			
		930R, RUBY SUPERSYSTEM	
CI INKS.....	CIM4542.....	NYLON RIBBON PUR.....	3.99
		DIAMOND, EMERALD, GEMSTONE, P220,250,500, SAPPHIRE SUPERSYSTEM, TRANZ 330 W, P250 PTR.	
CI INKS.....	CIM5183.....	ERC-23 RIBBON BLK/RED.....	3.99
GENERAL.....	GRCE287BR.....	NYLON RIBBON BLK/RED.....	5.95
		P100	
CI INKS.....	CIM5602.....	NYLON RIBBON PUR.....	4.50
		TRANZ 420, 460	
CI INKS.....	CIM5722.....	ERC-09 RIBBON PUR.....	4.25
GENERAL.....	GRCE281P.....	NYLON RIBBON PUR.....	4.50
VICTOR			
-CALCULATORS			
		12P,1250/A	
GENERAL.....	GRCR872B.....	IR72 INK ROLL BLK.....	4.50

MANUFACTURER	ITEM NO.	DESCRIPTION	LIST
VICTOR (cont.)			
		350, 380, 605, 610, 620, 660, 670, 675, 800, 820-860,1280, 1500/-5, 1520/-4/-5, 1530/-4/-5/-6, 1550/-4/-5, 1560/-4/-5/-6, 1570/-4/-5/-6, 1600, 1645, 1655, 1666, 1670, 1675	
MONROE	MNEP51S.....	NYLON RIBBON BLK/RED.....	15.00
VICTOR.....	VCT7011.....	NYLON RIBBON BLK/RED.....	5.10
		1205, 1208, 1220/-2, 1225, 1242, PD1242	
GENERAL.....	GRCR840B.....	CP16 INK ROLL BLK.....	4.50
CI INKS.....	CIMIR40.....	CP16 INK ROLL BLK.....	2.05
PORELON	PORPR40.....	INK ROLL BLK.....	3.99
		1208-2,1210-2,1212/-2,1225-2,1228/-2,1230/-2/3, 1245,1297	
CI INKS.....	CIMIR40T.....	CP13 INK ROLL BLK/RED.....	2.45
GENERAL.....	GRCR842BR.....	INK ROLL BLK/RED.....	4.50
		1210	
PORELON	PORPR12.....	CP12 INK ROLL BLK/RED.....	3.99
		1240/-2, 1260/-2, 1280/A/III/-4/-5/-6, 1400-3, 1430/2/-3,1460/-2/-3, 1480-3, 2640, 3000, 3001, 3012	
VICTOR.....	VCT7010.....	FABRIC RIBBON BLK/RED.....	3.85
GENERAL.....	GRCE201BR.....	FABRIC RIBBON BLK/RED.....	3.50
		1500A, 1520/A/III, 1530/A/III, 1550/A/III, 1560/A/III, 1570/A/III	
MONROE	MNEP71M.....	NYLON RIBBON BLK/RED.....	13.00
		3015, 3100, 4000, VANGUARD 3015, 3100, 4000	
CI INKS.....	CIM5602.....	NYLON RIBBON PUR.....	4.50
-CASH REGISTER			
		2700, 3008	
CI INKS.....	CIMIR90.....	IR90 INK ROLL PURPLE.....	8.99

*Thank you for
your continued
loyalty.*

Call Your Sales Representative Today



NXT PREMIUM REPLACEMENT INK AND LASER CARTRIDGES

We carry the widest selection of Compatible and Remanufactured Ink and Laser Cartridges. All of our toners are guaranteed to perform equal to or better than the OEM. NXT Premium Replacement Cartridges contain only the highest quality components for optimal printing performance and image quality. All components are life tested to meet or exceed OEM specifications insuring you have the best replacement cartridge in the industry.

Our Industry Leading Lifetime Guarantee

All NXT Premium Replacement Cartridges are guaranteed to be free from defects in workmanship and materials for the life of the cartridge. We stand behind our products so you can too. If your cartridge is deemed defective, simply contact our returns department to initiate the return process.

**More information can be found at
www.nxtpremium.com**



The NeXT Best Thing in Toner!



Success enabled

Grow your capabilities. Grow your business.



Productivity. Reliability. Value.

Intelligent new Lexmark color family of printers and MFPs take your productivity to a whole new level.